



Specialist Vehicles Product Guide

Working in partnership with

 Travis Perkins

Tool Hire
Tools, plant & equipment



0345 745 0000
nationwideplatforms.co.uk

 **Nationwide
Platforms**
A **LOXAM** Company

How to use this Product Selection Guide

This guide is designed to help you select and order the correct piece of equipment for your needs.

Each section is conveniently separated by product type and machines are arranged in order of ascending height.

The working envelope and height/reach indicator will provide a quick visual reference to assist your equipment selection.

If you cannot find exactly what you're looking for, need more information, or wish to order equipment, call our expertly trained staff on **0345 745 0000**

Key

Standard features

Battery power	Tracked
Diesel power	Mast boom
Lithium battery	Articulating boom
Hybrid power	Straight telescopic boom
Dual fuel option	Non-marking tyres
Rough terrain (2 wheel drive)	Outrigger legs
Rough terrain (4 wheel drive)	Maximum people in cage*
IPAF licence type	Self drive
IPAF licence type	JIB rotation
IPAF licence type	IPAF driving licence type
IPAF licence type	

Working Height (m)

Max Horizontal Outreach (m)

Optional extras

SkySiren®	Power to platform
SkySiren® PCS™	Generator
SkySentry™	Camera pod
SkyRakBoom®	Circular camera cage
SkyTel™	Wendy lighting frame

- Product Code**
Unique reference number for product. (Please note this will not necessarily correspond with the original manufacturer's model number or product code)
- Specification**
These details include product dimensions, Safe Working Load (SWL), platform area, rotation and machine weight.
- Key**
These symbols indicate standard features and optional extras available to hire with the platform. See left for key table.
- Machine Dimensions / Extra info**
Our Tracked Booms pages are supplemented with Machine Dimension diagrams. Other products show extra information like Machine Attributes, Additional Functionality and License Requirements.
- Product Type**
Indicates classification of powered access unit, e.g. machine types: van mounted, truck mounted platforms, or tracked booms.
- Alternative Machines**
Indicates alternative or similar machines.
- Working Envelope**
This shows the area of working space provided by the product.



How to use this Product Selection Guide

This guide is designed to help you select and order the correct piece of equipment for your needs.

Each section is conveniently separated by product type and machines are arranged in order of ascending height.

The working envelope and height/reach indicator will provide a quick visual reference to assist your equipment selection.

If you cannot find exactly what you're looking for, need more information, or wish to order equipment, call our expertly trained staff on **0345 745 0000**

operator driven

T38B
Specification

Working Height
38.0

Max Horizontal Outreach
25.3

WORKING CAPABILITY

Working Height	38.0m
Max Horizontal Outreach	25.3m (20kg)
Max Horizontal Outreach (Full SWL)	21.0m
Max Reach below 0m (negative outreach)	5.5m
Platform width	2.2m x 1.05m
Swinging cage	3.7m
Operational Full SWL	8.2m
Minimum Clearance path (straight down parking)	2.0m

MACHINE DIMENSIONS

Overall reach length	10.2m
Overall boom height	3.7m
Overall mast height	2.2m
Max SWL	1000kg
Crane weight (empty crane)	1000kg

MACHINE ATTRIBUTES

# wheel drive	4x4
Number of axles	2
Max. wheel	800mm
Articulated boom / Stick boom	Stick boom
Platform height	4.2m
Crane articulation	45°
Jacking type	Hydraulic
Propulsion / Drive	1000W/24VDC
Tyre type / pressure	2.75R16
Lock or High-traction drive	Lock

ADDITIONAL FUNCTIONALITY

Roaming mode	Yes
Starting Cabin	Yes
Self Drive	Yes
Power to platform	110v/16A
Anti-slip and safety mats	Yes
Control Camera Edge option	Yes
Lighting option	Yes
Camera pod option	Yes
Camera cable	Yes
Max operating temperature	12.5m

LICENSE REQUIREMENTS

Vehicle driving license type	RCV
Operator Training Level (PTW)	Yes
Self Drive option	Yes
Operating Noise level	48dB(A)
Operating Temp range	-20° to +45° C
Manufacturer	Brooks
Product code reference	T38B

WORKING ENVELOPE

0345 745 0000
nationwideplatforms.co.uk

Welcome to our powered access selection guide. Inside you'll find all the information you need to begin working safely and effectively at height.

To get you started we've included comprehensive guidance on our leading product range, as well as advice on the accessories, innovations and training that'll help you succeed on your next task or project.

Remember, if you want to get in touch with us at any point whilst you're browsing, you can give us a call with any enquiries, feedback or hire requests.

Welcome

Key

Standard features

- Battery power
- Diesel power
- Lithium battery
- Hybrid power
- Dual fuel option
- Rough terrain (2 wheel drive)
- Rough terrain (4 wheel drive)
- IPAF licence type
- IPAF licence type
- IPAF licence type
- IPAF licence type
- Tracked
- Mast boom
- Articulating boom
- Straight telescopic boom
- Non-marking tyres
- Outrigger legs
- Maximum people in cage*
- Self drive
- JIB rotation
- IPAF driving licence type

Working Height (m) ↑

Max Horizontal Outreach (m) →

Optional extras

- SkySiren®
- SkySiren® PCS™
- SkySentry™
- SkyRakBoom®
- SkyTel™
- Power to platform
- Generator
- Camera pod
- Circular camera cage
- Wendy lighting frame

- 1 Product Code**
Unique reference number for product. (Please note this will not necessarily correspond with the original manufacturer's model number or product code)
- 2 Specification**
These details include product dimensions, Safe Working Load (SWL), platform area, rotation and machine weight.
- 3 Key**
These symbols indicate standard features and optional extras available to hire with the platform. See left for key table.
- 4 Machine Dimensions / Extra info**
Our Tracked Booms pages are supplemented with Machine Dimension diagrams. Other products show extra information like Machine Attributes, Additional Functionality and License Requirements.
- 5 Product Type**
Indicates classification of powered access unit, e.g. machine types: van mounted, truck mounted platforms, or tracked booms.
- Alternative Machines**
Indicates alternative or similar machines.
- Working Envelope**
This shows the area of working space provided by the product.



0345 745 0000
nationwideplatforms.co.uk



Contents

Equipment selection / Self drive process	5
<hr/>	
Tracked boom lifts	6–17
Van mounted platforms	18–23
Self-drive truck mounted	24–39
Operator driven vehicle mounted platforms	40–51
Operator driven big kit	52–61
<hr/>	
Case studies	62–64
Training	66–67
IPAF Rental	68
Engineering Excellence	70
Equipment Sales	71
Innovation	72–73
Advice and support	74
Regulations	75
Location	76

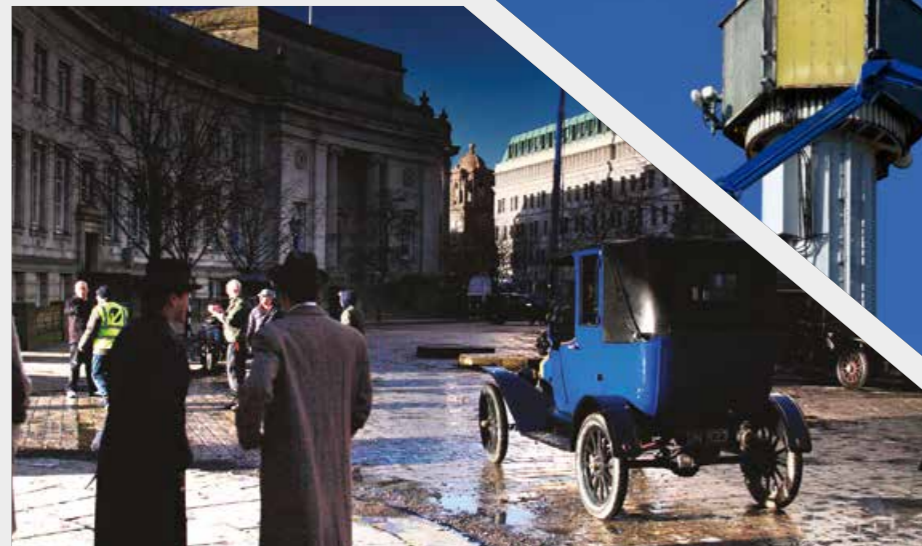

Equipment selection

Considerations in selecting the right equipment for your task:

1 **Height and outreach**
Do I need to reach a height straight up or do I need to reach up and then over?
Our Specialist Vehicles offer both vertical access and outreach. When making your product selection, ensure you consider the outreach required for the task at hand.

4 **Access**
Are there any access restrictions to entering the working environment?
Indoors, will machines pass through doorways and lift shafts? Does the site have plant weight restrictions?

2 **Environment**
Will I be working indoors or outdoors?
Our electric and dual-fuel Tracked Booms offer the ideal solution when working indoors.

5 **Working height**
How far up and how far out do I need to reach?
Always check the working envelope diagrams to ensure the outreach required can be achieved at the height(s) you need to carry out your task. Also consider that maximum working heights are assumed as 2m above the platform height (feet level).

3 **Terrain**
What are the ground conditions I'll be working on?
Whether working indoors on delicate ground or outdoors on soft or rough terrain, you may need to consider our advanced ground protection.

6 **Hire duration**
How long do I need a machine for?
Self drive and other vehicle mounted platforms may suit short projects. We offer machine hires from one day to many years, as well as equipment for outright purchase.

Self drive process

Our Specialist Vehicle self drive depots allow you to access the UK's most comprehensive fleet of self drive vehicle mounted platforms. Usually all you need is a standard driving licence to hire from our flexible and capable platforms up to 26m. You will receive expert advice, and full familiarisation with every powered access hire enabling you to complete one task then simply drive on to tackle the next.



To ensure you specify the right platform for your task:

- 1** Call our Hire Desk specialist
- 2** Review your working at height needs against our Equipment Selection guide above
- 3** Confirm driving IPAF licence requirements
- 4** Collect your vehicle for one of our specialist depots
- 5** Get the job done – return the platform

Tracked Boom Lifts

Typical applications

- Facility Management
- Cleaning & Maintenance
- Tree Surgery
- Telecoms
- House Building
- Exhibitions & Events
- Power & Energy

Range attributes

- Working heights ranging from 14 to 31 metres
- Compact, light and easily manoeuvrable, our tracked booms offer versatile access to remote sites
- Able to pass through narrow aisles and standard sized doorways
- Robust rubber tracks provide ideal footing on soft, delicate flooring or rough terrain
- Available with dual fuel or lithium batteries for emission free access
- Ideal for internal and external locations

Self Drive



Case study

Product

Teupen TB31TB

Application / Sector

Telecommunications

Project Details

To aid the inspection of a mobile telecommunications tower located in a remote field outside Chertsey, Nationwide Platforms provided UTEC Star Nett Geomatics with its largest tracked boom lift.

With a working height of 31 metres and an outreach of 17.7 metres, the TB31TB was easily able to overcome a perimeter fence surrounding the tower, allowing for the engineer to closely inspect all elements of the six antennas.

The TB31TB's height and width-adjustable rubber tracks also provided exceptional traction and stability when traversing the field, while its automatic levelling outriggers ensured its safe set-up and operation.

TB14HB / TB14HE



Specification

Working Height (m) 
14.0

Max Horizontal Outreach (m) 
7.0

WORKING CAPABILITIES	
Working Height	14.0m
Max Horizontal Outreach	7.0m
Closed Length	4.06m
Closed Height	1.99m
Closed Width (Without basket)	0.78m
Platform Size	1.33m x 0.69m
Rotation	360°
Max SWL†	200kg
Weight	1750kg
Outrigger Footprint	2.7m x 2.7m
Max ground pressure on stabilisers	1330daN - 1,9daN/cm2
Manufacturer	Hinowa
Alternative machines	TB17HE / TB17HB



MACHINE DIMENSIONS

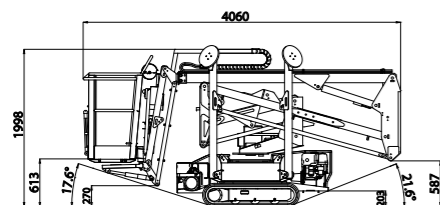

Side elevation

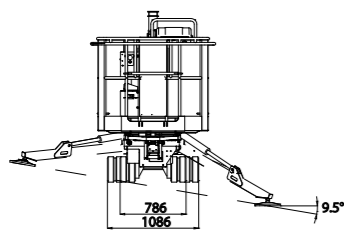

Front elevation

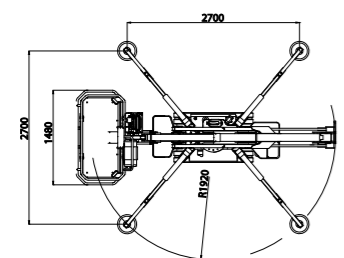

Top elevation

WORKING ENVELOPE

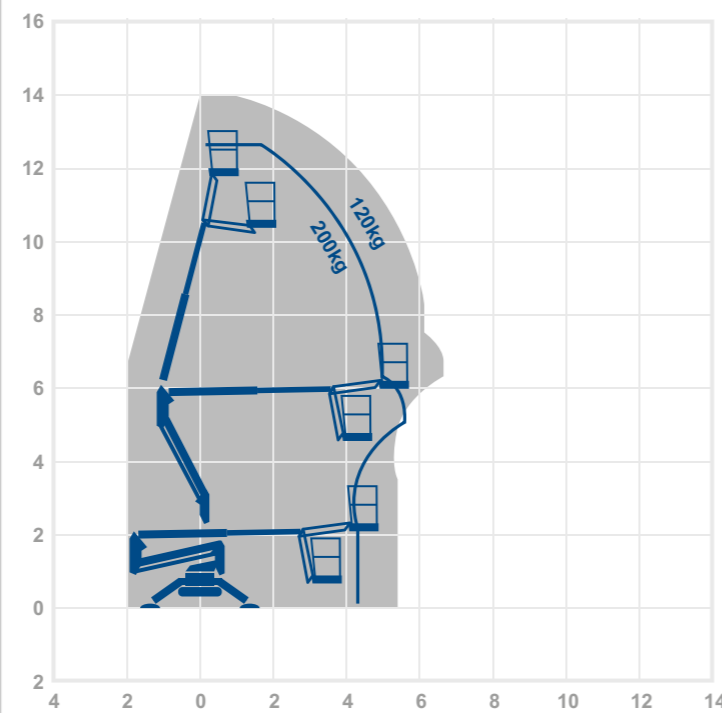

† Depending on load, angle of rotation and outrigger configuration.

0345 745 0000
nationwideplatforms.co.uk

TB15HB / TB15HE



Specification

Working Height (m) 
15.4

Max Horizontal Outreach (m) 
6.6

WORKING CAPABILITIES	
Working Height	15.4m
Max Horizontal Outreach	6.6m
Closed Length	4.02m
Closed Height	1.99m
Closed Width (Without basket)	0.75m
Platform Size	1.33m x 0.69m
Rotation	360°
Max SWL	230kg
Weight	1950kg
Outrigger Footprint	2.8m x 2.8m
Max ground pressure on stabilisers	1670daN - 2,36daN/cm2
Manufacturer	Hinowa
Alternative machines	TB17HE / TB17HB



MACHINE DIMENSIONS

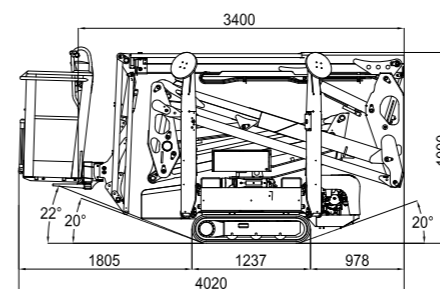

Side elevation

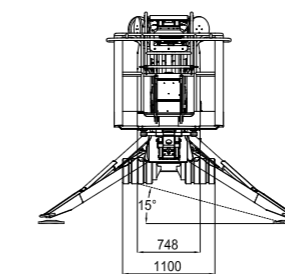

Front elevation

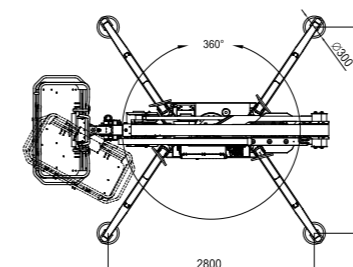

Top elevation

WORKING ENVELOPE

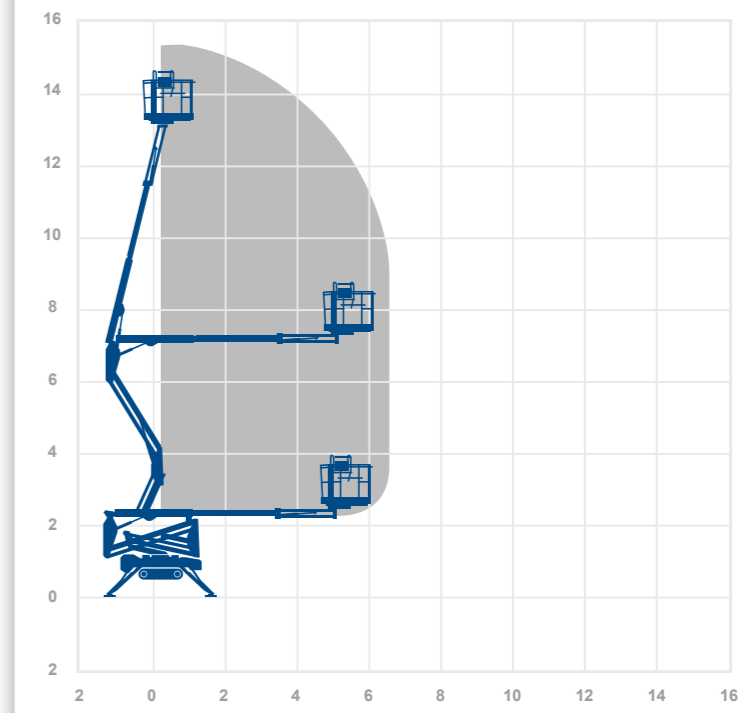

0345 745 0000
nationwideplatforms.co.uk

TB17HB / TB17HE



Specification

Working Height (m)
17.06

Max Horizontal Outreach (m)
7.5

WORKING CAPABILITIES

Working Height	17.06m
Max Horizontal Outreach	7.5m
Closed Length	4.52m
Closed Height	2.00m
Closed Width (Without basket)	0.79m
Platform Size	1.33m x 0.69m
Rotation	360°
Max SWL	230kg
Weight	2280kg
Outrigger Footprint	2.88m x 2.89m
Max ground pressure on stabilisers	1731daN - 2,45daN/cm2
Manufacturer	Hinowa
Alternative machines	TB20HE / TB20HB



MACHINE DIMENSIONS

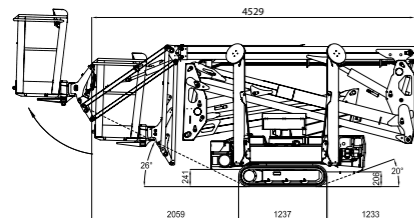

Side elevation

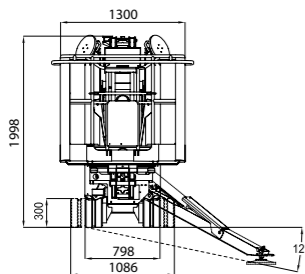

Front elevation

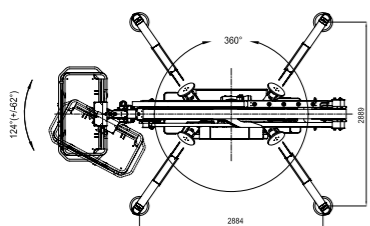

Top elevation

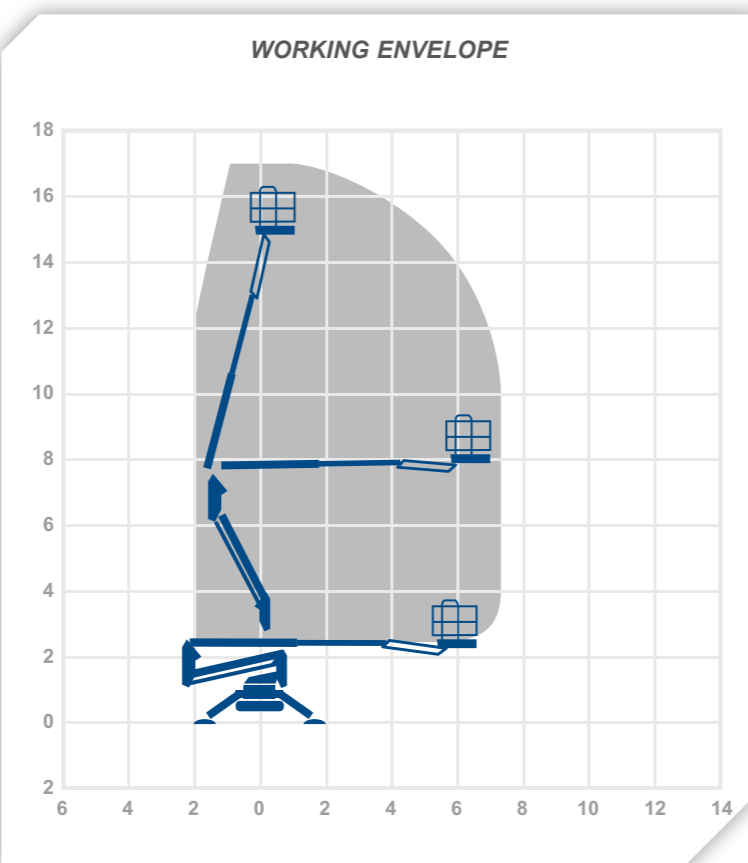

0345 745 0000
nationwideplatforms.co.uk

TB18PB



Specification

Working Height (m)
17.6

Max Horizontal Outreach (m)
9.2

WORKING CAPABILITIES

Working Height	17.6m
Max Horizontal Outreach	9.2m
Closed Length	5.21m
Closed Height	1.95m
Closed Width (Without basket)	0.78m
Platform Size	1.30m x 0.70m
Rotation	360°
Max SWL	200kg
Weight	2350kg
Outrigger Footprint	3.0m x 3.66m
Max ground pressure on stabilisers	2,52 kN/m2
Manufacturer	Platform Basket
Alternative machines	TB20HE



MACHINE DIMENSIONS

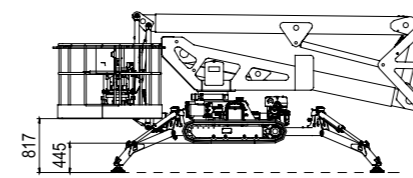

Side elevation

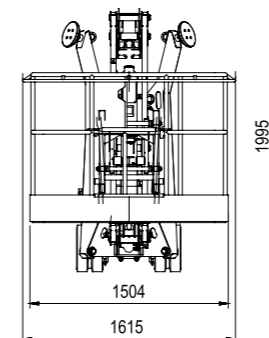

Front elevation

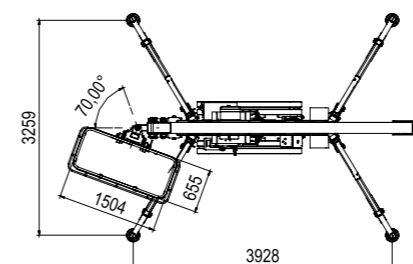

Top elevation

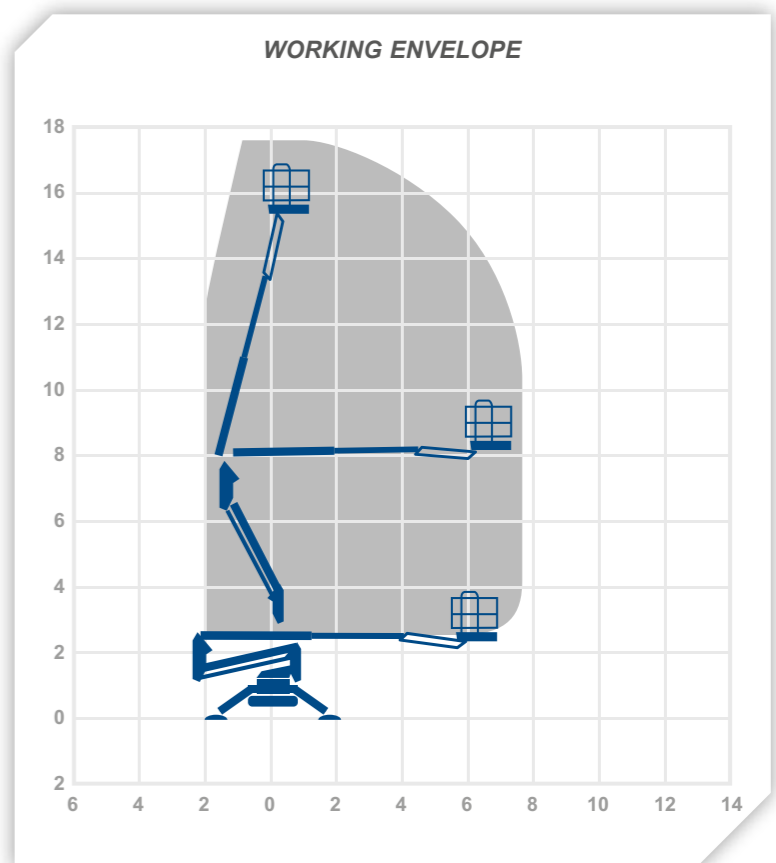

0345 745 0000
nationwideplatforms.co.uk

TB20JB

Specification

Working Height (m)
20.1

Max Horizontal Outreach (m)
9.7



WORKING CAPABILITIES

Working Height	20.1m
Max Horizontal Outreach	9.7m
Closed Length	5.01m
Closed Height	1.99m
Closed Width (Without basket)	0.79m
Platform Size	1.33m x 0.69m
Rotation	360°
Max SWL	230kg
Weight	2880kg
Outrigger Footprint	2.92m x 2.92m
Max ground pressure on stabilisers	2150daN - 3,04daN/cm ²
Manufacturer	Hinowa
Alternative machines	TB20HE / TB26HE / TB26HB



MACHINE DIMENSIONS

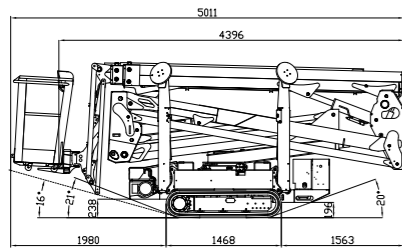

Side elevation

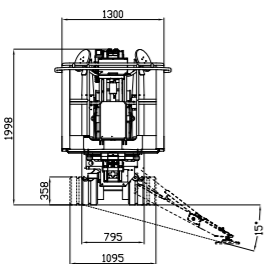

Front elevation

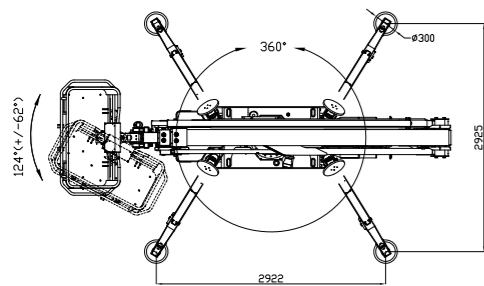

Top elevation

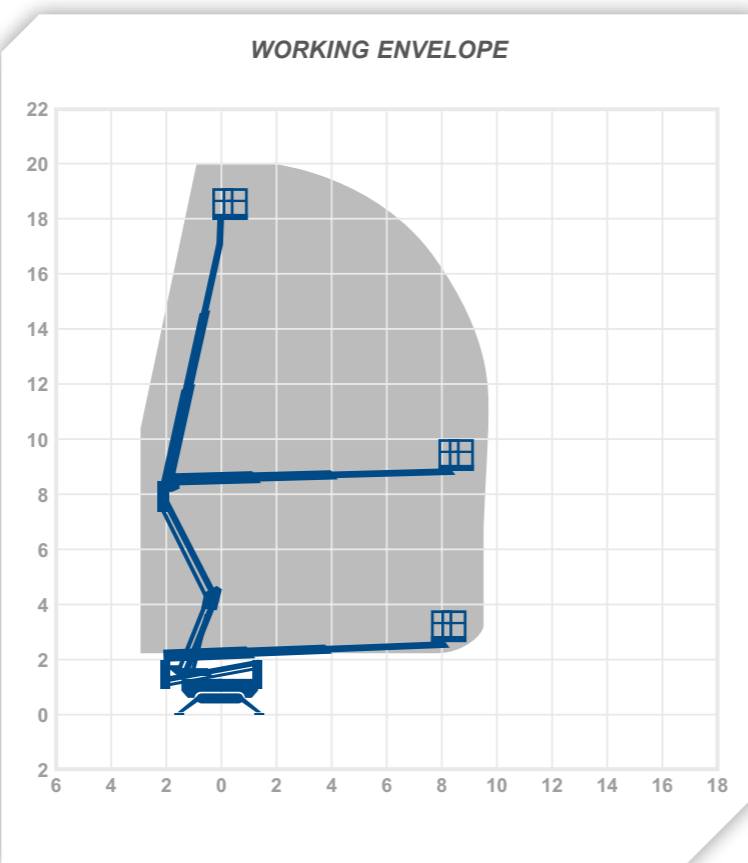

0345 745 0000
nationwideplatforms.co.uk

TB20HB / TB20HE

Specification

Working Height (m)
20.1

Max Horizontal Outreach (m)
9.7



WORKING CAPABILITIES

Working Height	20.1m
Max Horizontal Outreach	9.7m
Closed Length	5.01m
Closed Height	1.99m
Closed Width (Without basket)	0.79m
Platform Size	1.33m x 0.69m
Rotation	360°
Max SWL	230kg
Weight	2880kg
Outrigger Footprint	2.92m x 2.92m
Max ground pressure on stabilisers	2150daN - 3,04daN/cm ²
Manufacturer	Hinowa
Alternative machines	TB26HE / TB26HB



MACHINE DIMENSIONS

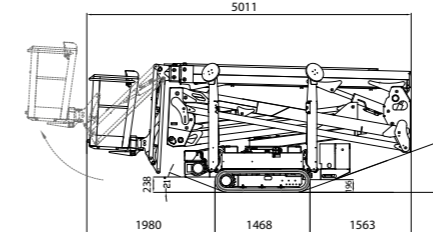

Side elevation

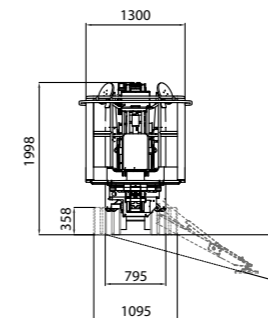

Front elevation

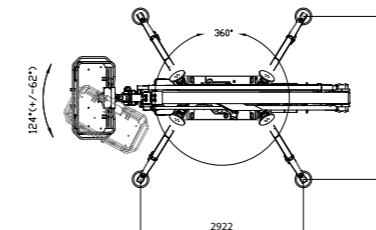

Top elevation

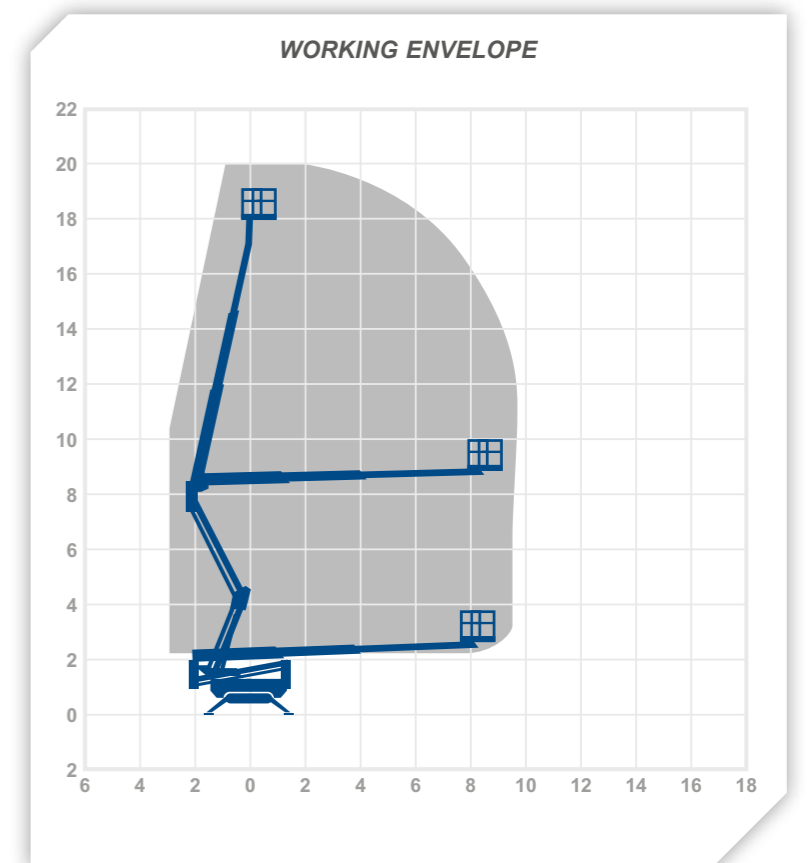

0345 745 0000
nationwideplatforms.co.uk

TB26HB / TB26HE



Specification

Working Height (m) 
25.7

Max Horizontal Outreach (m) 
13.6

WORKING CAPABILITIES	
Working Height	25.7m
Max Horizontal Outreach	13.6m
Closed Length	6.34m
Closed Height	1.98m
Closed Width (Without basket)	0.99m
Platform Size	1.33m x 0.69m
Rotation	360°
Max SWL	230kg
Weight	4415kg
Outrigger Footprint	4.07m x 3.97
Max ground pressure on stabilisers	3124daN - 4,42daN/cm2
Manufacturer	Hinowa
Alternative machines	TB26HE / TB30MB / TB31TB



MACHINE DIMENSIONS

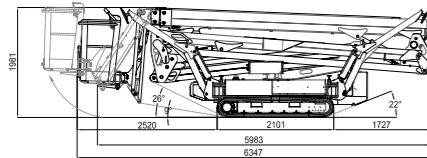

Side elevation

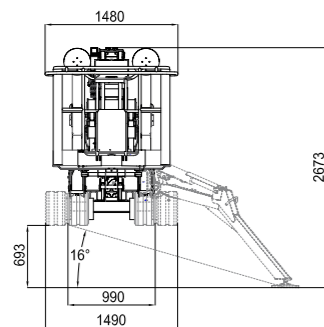

Front elevation

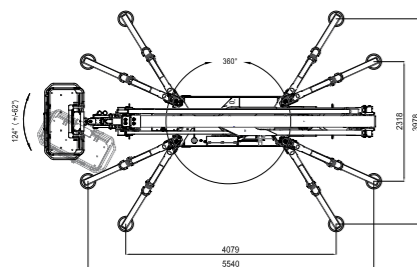

Top elevation

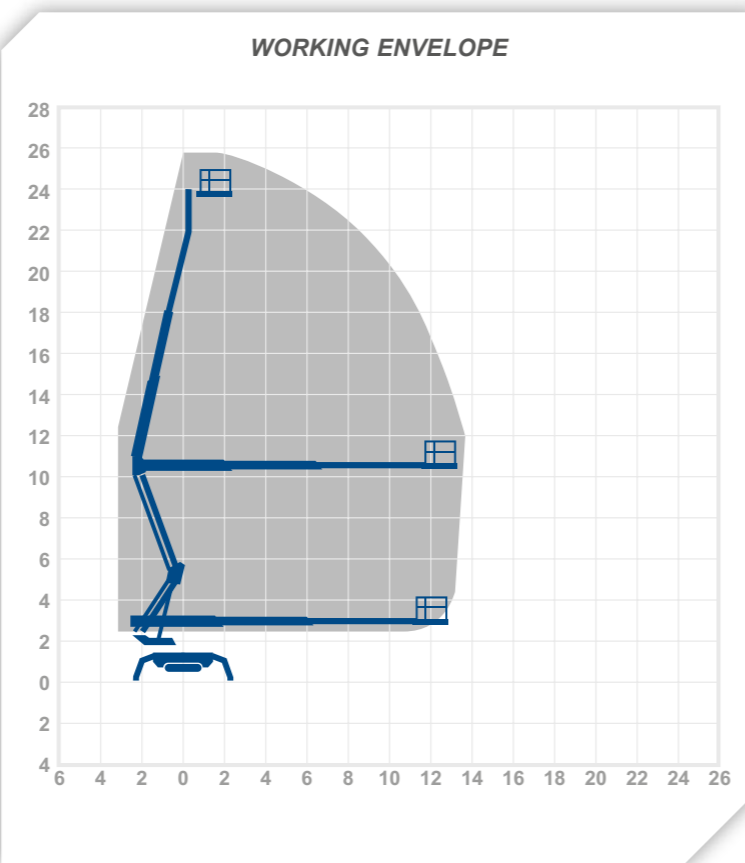

0345 745 0000
nationwideplatforms.co.uk

TB30MB



Specification

Working Height (m) 
30.0

Max Horizontal Outreach (m) 
14.0

WORKING CAPABILITIES	
Working Height	30.0m
Max Horizontal Outreach	14.0m
Closed Length	6.65m
Closed Height	2.3m
Closed Width (Without basket)	1.6m
Platform Size	1.60m x 0.70m
Extending Cage	4.2m
Rotation	400°
Max SWL†	270kg
Weight	5600kg
Outrigger Footprint	6.4m x 4.2m
Max pressure over one leg at full outreach WITHOUT outrigger	27,3kN
Max pressure over one leg at full outreach WITH outrigger pad	25,0kN
Manufacturer	Multitel
Alternative machines	TB31TB



MACHINE DIMENSIONS



Side elevation

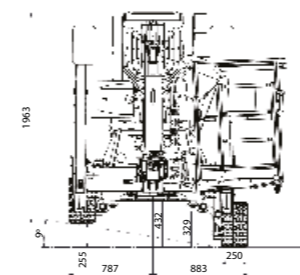

Front elevation

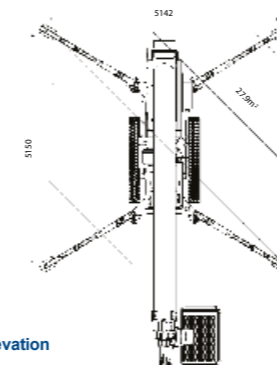

Top elevation

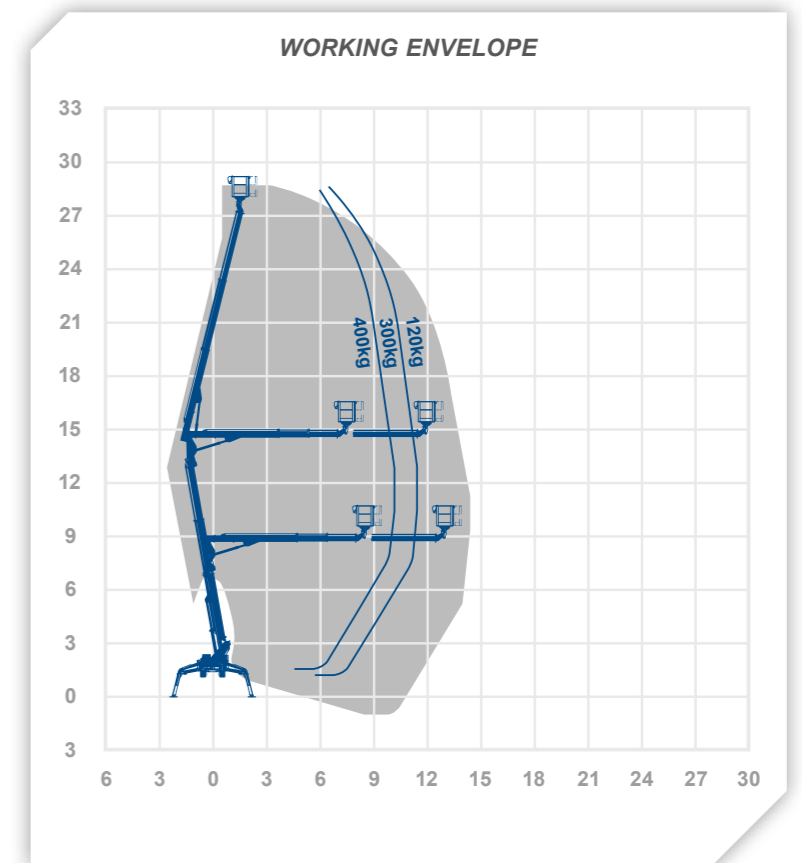

† Depending on load, angle of rotation and outrigger configuration.

0345 745 0000
nationwideplatforms.co.uk

TB31TB Dual

Specification



Working Height (m)
31.0

Max Horizontal Outreach (m)
14.7

WORKING CAPABILITIES

Working Height	31.0m
Max Horizontal Outreach	14.7m
Closed Length	7.23m
Closed Height	1.98m
Closed Width (Without basket)	1.58m
Platform Size	1.2m x 0.8m
Rotation	360°
Max SWL†	250kg
Weight	4350kg
Outrigger Footprint	5.45m x 5.15m
Max pressure over one leg at full outreach WITHOUT outrigger	27,3kN
Max pressure over one leg at full outreach WITH outrigger pad	25,0kN
Manufacturer	Teupen
Alternative machines	TB26HB / TB26HE



MACHINE DIMENSIONS

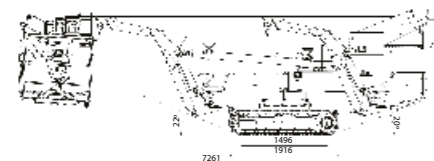

Side elevation

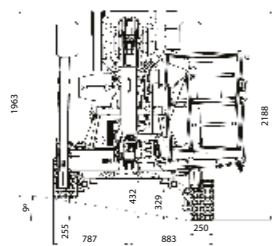

Front elevation

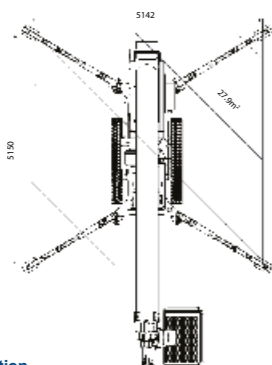

Top elevation

WORKING ENVELOPE

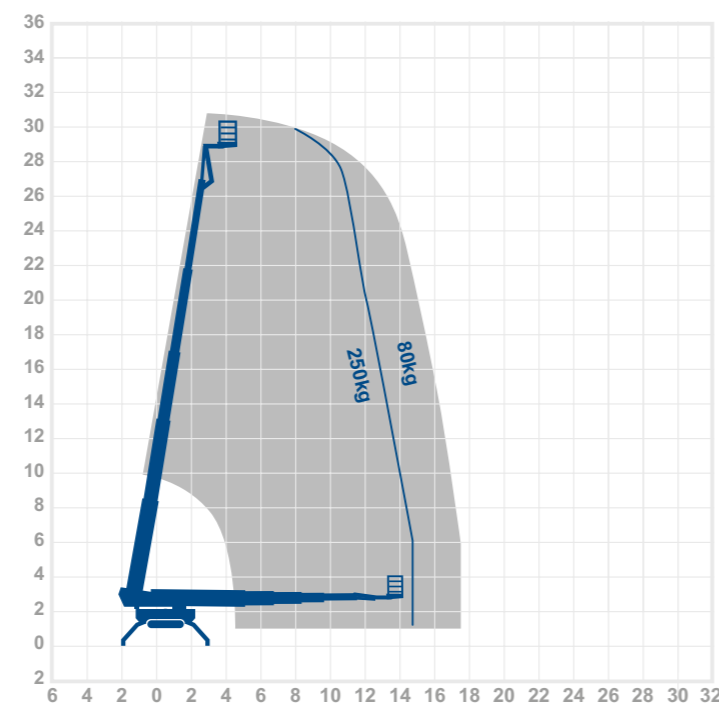

† Depending on load, angle of rotation and outrigger configuration.

0345 745 0000
nationwideplatforms.co.uk



Van mounted platforms

Typical applications

- General Maintenance
- Street furniture & Lighting
- Window repair & Fitting
- Signage
- Roofing

Range attributes

- Working heights from 13 to 17 metres
- Ideal for short and long-term hires
- Can be driven on a standard European B Car Licence
- Easily driven from location to location, offering you the flexibility to work the hours which suit you
- Internal racking, ply lining and hot and cold hand wash available
- Spare payload capacities offering equipment storage up to 1000kg
- Tracker devices available as options on long term hires
- 4-wheel drive models available

Self Drive



Case study

Product

V14E

Application / Sector

General Maintenance

Project Details

The maintenance team for a large private estate required a working at height solution to carry out a variety of repair and maintenance tasks. These tasks extended from gutter cleaning, planned lighting maintenance, to glazing and repairs.

Nationwide Platforms provided a V14E Van Mounted Platform, allowing each assignment to be carried out swiftly and efficiently enabling various trades to complete several tasks at a variety of locations in one day.

The spare payload of 800kg provided sufficient capability for transporting tools and equipment, further increasing the overall project efficiency in manpower and time.



V12E Specification



Working Height (m)
13.0

Max Horizontal Outreach (m)
7.0

WORKING CAPABILITIES	
Working Height	13.0m
Max Horizontal Outreach	7.0m
Max Horizontal Outreach (full SWL)	7.0m
Max Reach below 0m (negative envelope)	N/A
Platform/cage size	1.0m x 0.60m
Extending cage	No
Operational Full Width	2.45m
Minimum Operational width (straight down jacking)	2.45m

MACHINE DIMENSIONS	
Overall travel Length	6.74m
Overall travel Height	3.15m
Overall travel Width	2.2m
Max SWL	200kg
Gross vehicle weight class	3500kg

MACHINE ATTRIBUTES	
4 wheel drive	No
Number of axles	2
Rear steer	No
Articulated boom / Stick boom	Stick boom
Platform height	11.0m
One sided jacking	N/A
Jacking type	Stabilisers x2 wheels do not leave ground
Point load Front / Rear	Stabilisers x2 wheels do not leave ground
Typical ground pressure*	As above
Left or Right hand drive	Right
Spare payload	200kg

ADDITIONAL FUNCTIONALITY	
Rotating cage	N/A
Earthing Cable	No
Jib Boom	Yes
Power to platform (cable and outlets only)	110v cable
Circular Camera cage option	No
Lighting rig option	No
Camera pod option	No
Max operating windspeed	12.5m/s

LICENCE REQUIREMENTS	
Vehicle driving licence type	C1
Operator Trained Level IPAF	1b
Self Drive option	Yes

Operating Noise level	<85Db
Operating temp range	+5° to +40°C
Manufacturer	Versalift
Alternative machines	VT125K / V12AS / V14E

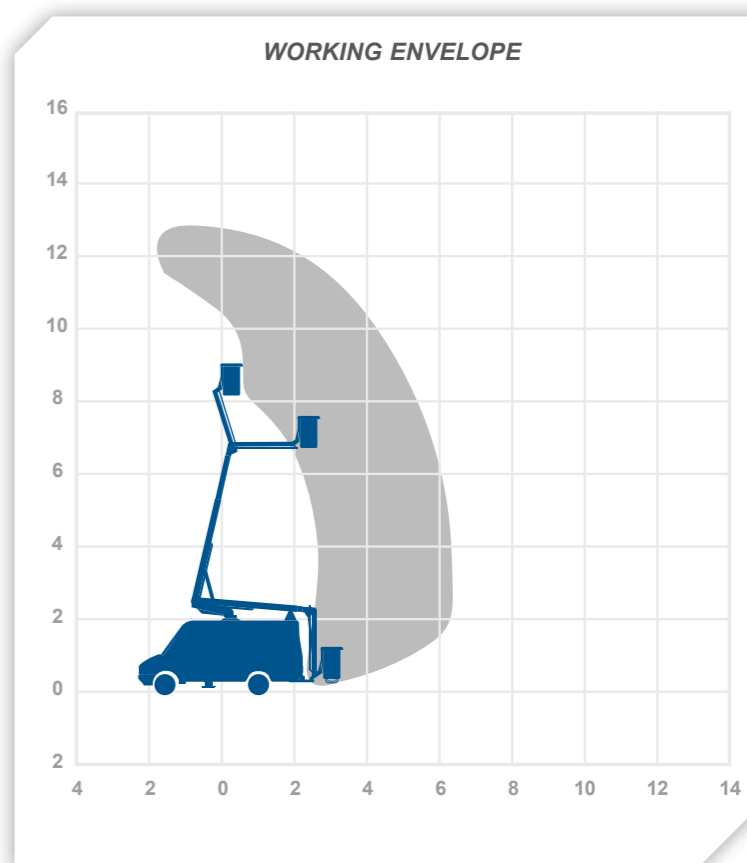

* (On standard spreader pads) these typical ground forces are based on the units standard size pad, the forces can be further reduced by scaling up the pad size.

0345 745 0000
nationwideplatforms.co.uk

V14E

Specification



Working Height (m)
14.2

Max Horizontal Outreach (m)
7.3

WORKING CAPABILITIES	
Working Height	14.2m
Max Horizontal Outreach	7.3m
Max Horizontal Outreach (full SWL)	7.3m
Max Reach below 0m (negative envelope)	N/A
Platform/cage size	1.0m x 0.6m
Extending cage	No
Operational Full Width	2.45m
Minimum Operational width (straight down jacking)	2.45m

MACHINE DIMENSIONS	
Overall travel Length	7.34m
Overall travel Height	3.8m
Overall travel Width	2.2m
Max SWL	200kg
Gross vehicle weight class	5200kg

MACHINE ATTRIBUTES	
4 wheel drive	No
Number of axles	2
Rear steer	No
Articulated boom / Stick boom	Stick boom
Platform height	12.3m
One sided jacking	N/A
Jacking type	Stabilisers x 2 wheels do not leave ground
Point load Front / Rear	Stabilisers x 2 wheels do not leave ground
Typical ground pressure*	As above
Left or Right hand drive	Right
Spare payload	800kg

ADDITIONAL FUNCTIONALITY	
Rotating cage	N/A
Earthing Cable	No
Jib Boom	Yes
Power to platform (cable and outlets only)	110v cable
Circular Camera cage option	No
Lighting rig option	No
Camera pod option	No
Camera cable	No
Max operating windspeed	12.5m/s

LICENCE REQUIREMENTS	
Vehicle driving licence type	C1
Operator Trained Level IPAF	1b
Self Drive option	Yes

Operating Noise level	<85Db
Operating temp range	+5° to +40°C
Manufacturer	Versalift
Alternative machines	V15AS / V16E

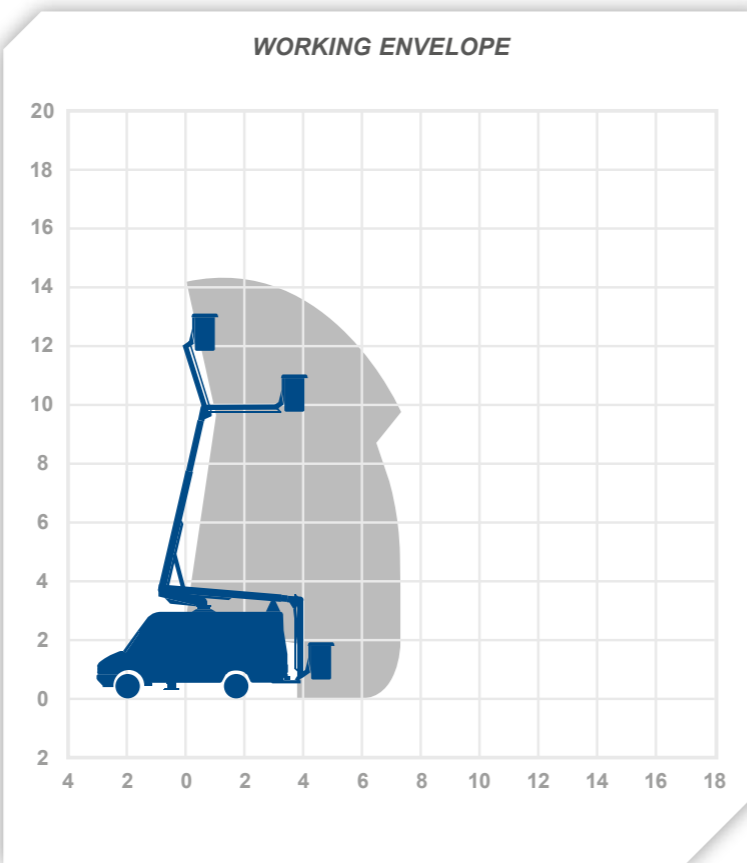

* (On standard spreader pads) these typical ground forces are based on the units standard size pad, the forces can be further reduced by scaling up the pad size.

0345 745 0000
nationwideplatforms.co.uk

V16E

Specification



Working Height (m)
16.5

Max Horizontal Outreach (m)
7.3

WORKING CAPABILITIES	
Working Height	16.5m
Max Horizontal Outreach	7.3m
Max Horizontal Outreach (full SWL)	7.3m
Max Reach below 0m (negative envelope)	N/A
Platform/cage size	1.0m x 0.6m
Extending cage	No
Operational Full Width	2.45m
Minimum Operational width (straight down jacking)	2.45m

MACHINE DIMENSIONS	
Overall travel Length	8.22m
Overall travel Height	4.0m
Overall travel Width	2.2m
Max SWL	200kg
Gross vehicle weight class	6500kg

MACHINE ATTRIBUTES	
4 wheel drive	No
Number of axles	2
Rear steer	No
Articulated boom / Stick boom	Articulated
Platform height	14.5m
One sided jacking	N/A
Jacking type	Stabilisers x 2 wheels do not leave ground
Point load Front / Rear	Stabilisers x 2 wheels do not leave ground
Typical ground pressure*	As above
Left or Right hand drive	Right
Spare payload	1000kg

ADDITIONAL FUNCTIONALITY	
Rotating cage	N/A
Earthing Cable	No
Jib Boom	Yes
Power to platform (cable and outlets only)	110v cable
Circular Camera cage option	No
Lighting rig option	No
Camera pod option	No
Camera cable	No
Max operating windspeed	12.5m/s

LICENCE REQUIREMENTS	
Vehicle driving licence type	C1
Operator Trained Level IPAF	1b
Self Drive option	Yes

Operating Noise level	<85Db
Operating temp range	+5° to +40°C
Manufacturer	Versalift
Alternative machines	T17BE

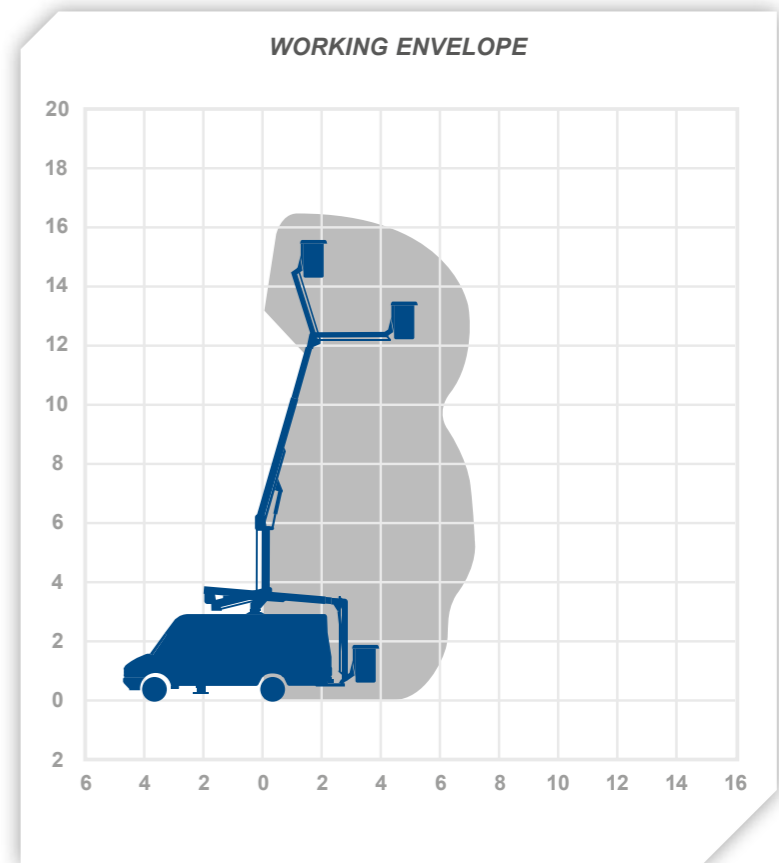

* (On standard spreader pads) these typical ground forces are based on the units standard size pad, the forces can be further reduced by scaling up the pad size.

0345 745 0000
nationwideplatforms.co.uk

Self-drive truck mounted

Typical applications

- Building Maintenance
- HVAC installation
- Telecoms
- Facia & Gutter Repairs
- Signage
- TV, Film & Events

Range attributes

- Self-drive options available on 3.5 tonne vehicles up to 20 metres and 7.5 tonne vehicles up to 26 metres
- Spread the cost of your hire across multiple sites and projects
- Collection and drop-off from our dedicated Specialist Vehicles depots across the UK
- Large fleet of 4-wheel drive machines, ideal for off road applications
- Narrow jacking and zero tail swing models available
- Safe working loads up to 300kg, ideal for fitting of our specialist sector attachments for Telecoms & Media clients
- Can be provided with one of our highly experienced, IPAF trained operators

Self Drive



Case study

Project

Frank Whittle Commemorative Plane

Product

Isuzu mounted Versalift T1135EX

Project Details

Nationwide Platforms recently provided one of its Isuzu mounted Versalift truck mounted platforms to a local charity to inspect a replica Gloster plane which commemorates the achievements of Sir Frank Whittle, inventor of the jet engine.

Fitted with BF Goodrich off-road tyres they had little difficulty gaining access to the replica aircraft which is mounted at the centre of a roundabout outside the town of Lutterworth.

Following poor weather and high winds, the 13.3 metre working height and 6.1 metre outreach allowed the engineer to closely inspect the exterior of the plane as well as the steelwork inside. Front radial outriggers also provided improved levelling and stability on the rough terrain compared with conventional 'A Frame' outriggers.

TI135EX

Specification



Working Height (m)
13.3

Max Horizontal Outreach (m)
6.1

WORKING CAPABILITIES

Working Height	13.3m
Max Horizontal Outreach	6.1m
Max Horizontal Outreach (full SWL)	6.1m
Max Reach below 0m (negative envelope)	N/A
Platform/cage size	1.0m x 0.6m
Extending cage	No
Operational Full Width	2.4m
Minimum Operational width (straight down jacking)	2.4m

MACHINE DIMENSIONS

Overall travel Length	4.7m
Overall travel Height	2.6m
Overall travel Width	2.0m
Max SWL	230kg
Gross vehicle weight class	3500kg

MACHINE ATTRIBUTES

4 wheel drive	Yes
Number of axles	2
Rear steer	No
Articulated boom / Stick boom	Articulated
Platform height	11.3m
One sided jacking	N/A
Jacking type	A Frame rear/forward and down front
Point load Front / Rear	20kN/20kN
Typical ground pressure*	1.8kgf/cm ²
Left or Right hand drive	Right

ADDITIONAL FUNCTIONALITY

Rotating cage	N/A
Earthing Cable	Yes
Jib Boom	No
Power to platform (cable and outlets only)	110v cable
Circular Camera cage option	No
Lighting rig option	No
Camera pod option	No
Camera cable	No
Max operating windspeed	12.5m/s

LICENCE REQUIREMENTS

Vehicle driving licence type	C1
Operator Trained Level IPAF	1b
Self Drive option	Yes

Operating Noise level	<85Db
Operating temp range	+5° to +40°C
Manufacturer	Versalift
Alternative machines	N/A

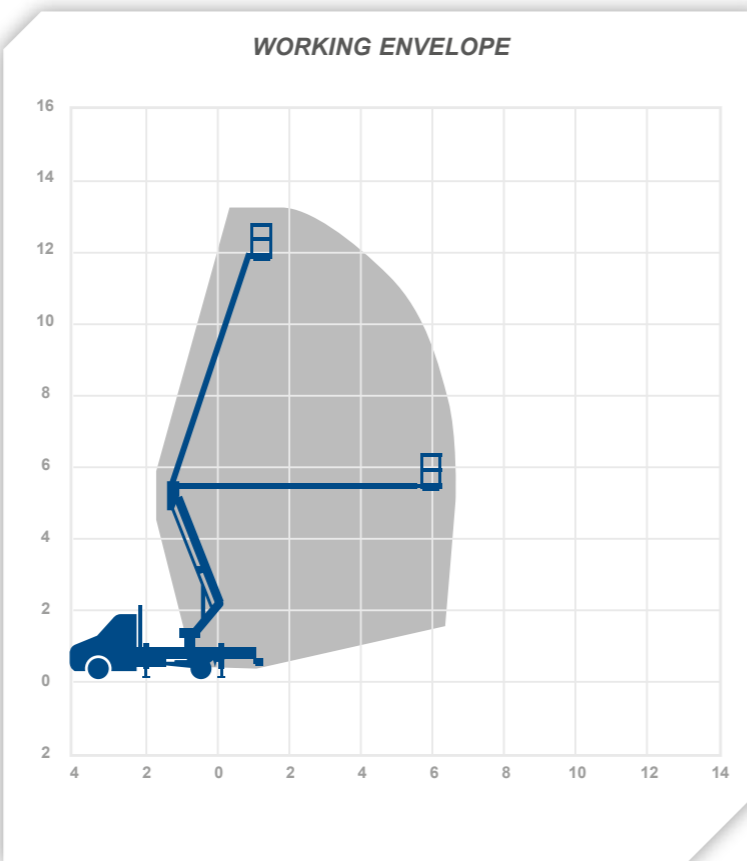
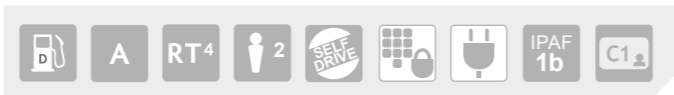

* (On standard spreader pads) these typical ground forces are based on the units standard size pad, the forces can be further reduced by scaling up the pad size.

0345 745 0000
nationwideplatforms.co.uk

T14GS

Specification



Working Height (m)
14.0

Max Horizontal Outreach (m)
8.0

WORKING CAPABILITIES

Working Height	14.0m
Max Horizontal Outreach	8.0m
Max Horizontal Outreach (full SWL)	8.0m
Max Reach below 0m (negative envelope)	N/A
Platform/cage size	1.4m x 0.7m
Extending cage	No
Operational Full Width	2.4m
Minimum Operational width (straight down jacking)	2.4m

MACHINE DIMENSIONS

Overall travel Length	7.2m
Overall travel Height	2.95m
Overall travel Width	2.1m
Max SWL	200kg
Gross vehicle weight class	3500kg

MACHINE ATTRIBUTES

4 wheel drive	No
Number of axles	2
Rear steer	No
Articulated boom / Stick boom	Stick
Platform height	13m
One sided jacking	N/A
Jacking type	A Frame
Point load Front / Rear	28kN/28kN
Typical ground pressure*	1.7kgf/cm ²
Left or Right hand drive	Right

ADDITIONAL FUNCTIONALITY

Rotating cage	Yes
Earthing Cable	No
Jib Boom	No
Power to platform (cable and outlets only)	110v cable
Circular Camera cage option	No
Lighting rig option	No
Camera pod option	No
Camera cable	No
Max operating windspeed	12.5m/s

LICENCE REQUIREMENTS

Vehicle driving licence type	C1
Operator Trained Level IPAF	1b
Self Drive option	Yes

Operating Noise level	<85Db
Operating temp range	+5° to +40°C
Manufacturer	T17GS

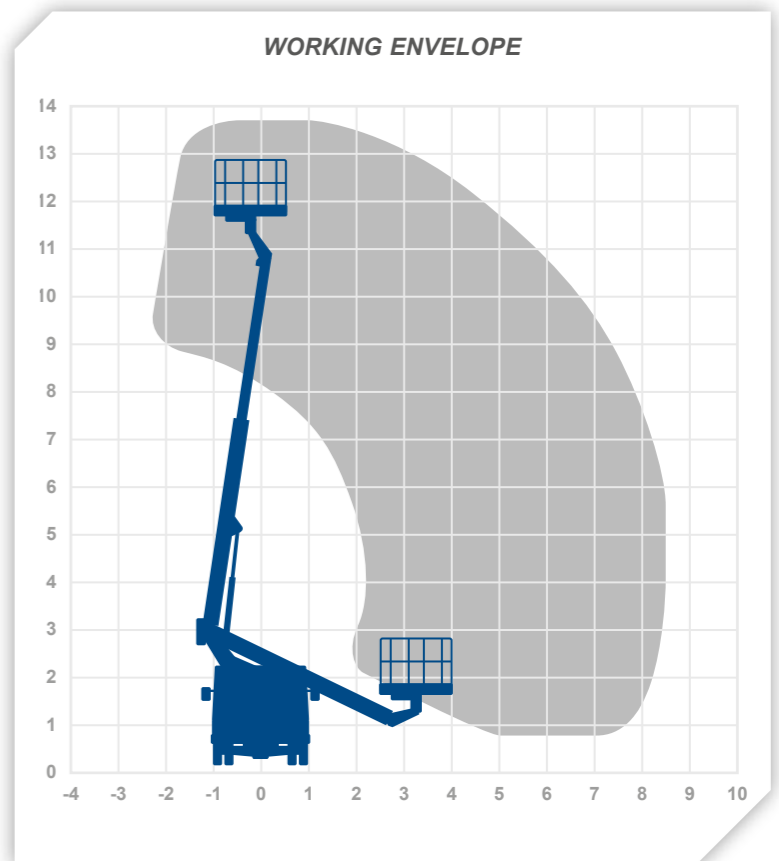

* (On standard spreader pads) these typical ground forces are based on the units standard size pad, the forces can be further reduced by scaling up the pad size.

0345 745 0000
nationwideplatforms.co.uk

T17GS

Specification

Working Height (m)
17.1

Max Horizontal Outreach (m)
9.5

WORKING CAPABILITIES	
Working Height	17.1m
Max Horizontal Outreach	9.5m
Max Horizontal Outreach (full SWL)	6.7m
Max Reach below 0m (negative envelope)	N/A
Platform/cage size	1.4m x 0.7m
Extending cage	No
Operational Full Width	2.4m
Minimum Operational width (straight down jacking)	2.4m

MACHINE DIMENSIONS

Overall travel Length	7.1m
Overall travel Height	2.95m
Overall travel Width	2.2m
Max SWL	250kg
Gross vehicle weight class	3500kg

MACHINE ATTRIBUTES

4 wheel drive	No
Number of axles	2
Rear steer	No
Articulated boom / Stick boom	Stick boom
Platform height	16.0m
One sided jacking	N/A
Jacking type	Straight down
Point load Front / Rear	28kN/28kN
Typical ground pressure*	1.7kgf/cm ²
Left or Right hand drive	Right

ADDITIONAL FUNCTIONALITY

Rotating cage	Yes
Earthing Cable	No
Jib Boom	No
Power to platform (cable and outlets only)	110v cable
Circular Camera cage option	No
Lighting rig option	No
Camera pod option	No
Camera cable	No
Max operating windspeed	12.5m/s

LICENCE REQUIREMENTS

Vehicle driving licence type	C1
Operator Trained Level IPAF	1b
Self Drive option	Yes

Operating Noise level	<85Db
Operating temp range	+5° to +40°C
Manufacturer	GSR
Alternative machines	T20GS / T20HC / T20K / T20M / T21JC

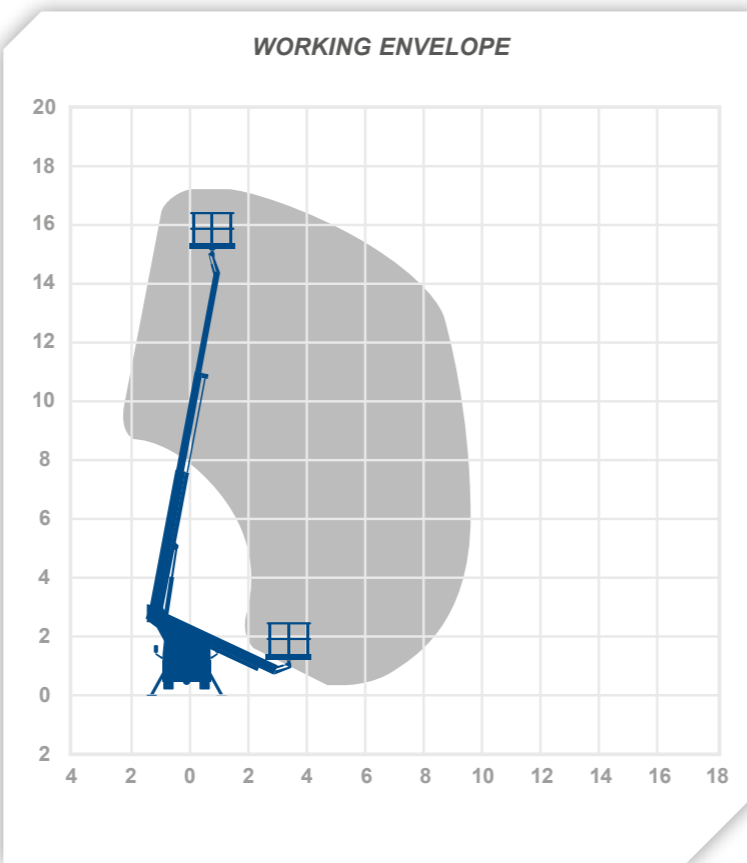

* (On standard spreader pads) these typical ground forces are based on the units standard size pad, the forces can be further reduced by scaling up the pad size.

0345 745 0000
nationwideplatforms.co.uk

T17BE

Specification

Working Height (m)
17.2

Max Horizontal Outreach (m)
10.0

WORKING CAPABILITIES	
Working Height	17.2m
Max Horizontal Outreach	10.0m
Max Horizontal Outreach (full SWL)	8.0m
Max Reach below 0m (negative envelope)	N/A
Platform/cage size	1.0m x 0.6m
Extending cage	No
Operational Full Width	2.4m
Minimum Operational width (straight down jacking)	2.4m

MACHINE DIMENSIONS

Overall travel Length	7.2m
Overall travel Height	3.7m
Overall travel Width	2.5m
Max SWL†	265kg
Gross vehicle weight class	6500kg

MACHINE ATTRIBUTES

4 wheel drive	No
Number of axles	2
Rear steer	No
Articulated boom / Stick boom	Stick boom
Platform height	17.0m
One sided jacking	N/A
Jacking type	H Frame
Point load Front / Rear	60kN/60kN
Typical ground pressure*	1.7kgf/cm ²
Left or Right hand drive	Right

ADDITIONAL FUNCTIONALITY

Rotating cage	Yes
Earthing Cable	No
Jib Boom	Yes
Power to platform (cable and outlets only)	110v inverter
Circular Camera cage option	No
Lighting rig option	No
Camera pod option	No
Camera cable	No
Max operating windspeed	12.5m/s

LICENCE REQUIREMENTS

Vehicle driving licence type	C1
Operator Trained Level IPAF	1b
Self Drive option	Yes

Operating Noise level	<85Db
Operating temp range	+5° to +40°C
Manufacturer	Versalift
Alternative machines	N/A

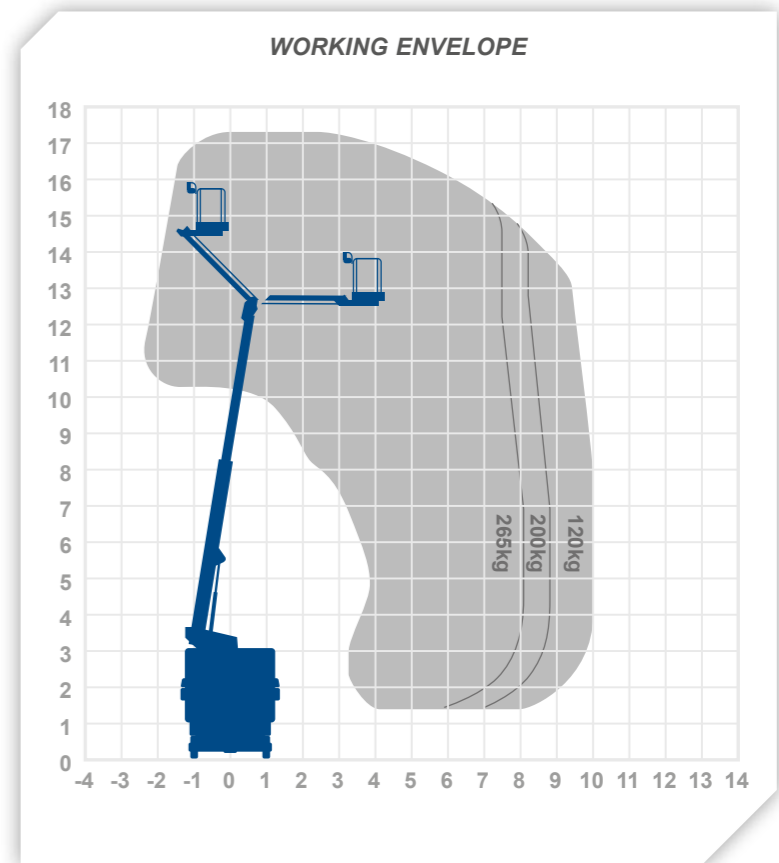

* (On standard spreader pads) these typical ground forces are based on the units standard size pad, the forces can be further reduced by scaling up the pad size.

† Depending on load, angle of rotation and outrigger configuration.

0345 745 0000
nationwideplatforms.co.uk

T18AS

Specification

Working Height (m)
18.0

Max Horizontal Outreach (m)
13.0

WORKING CAPABILITIES

Working Height	18.0m
Max Horizontal Outreach	13.0m
Max Horizontal Outreach (full SWL)	13.0m
Max Reach below 0m (negative envelope)	N/A
Platform/cage size	1.4m x 0.73m
Extending cage	No
Operational Full Width	3.6m
Minimum Operational width (straight down jacking)	2.3m

MACHINE DIMENSIONS

Overall travel Length	7.0m
Overall travel Height	3.0m
Overall travel Width	2.3m
Max SWL	230kg
Gross vehicle weight class	3500kg

MACHINE ATTRIBUTES

4 wheel drive	No
Number of axles	2
Rear steer	No
Articulated boom / Stick boom	Stick boom
Platform height	17.0m
One sided jacking	2.8m
Jacking type	H Frame
Point load Front / Rear	28kN/28kN
Typical ground pressure*	1.7kgf/cm ²
Left or Right hand drive	Right

ADDITIONAL FUNCTIONALITY

Rotating cage	Yes
Earthing Cable	No
Jib Boom	Yes
Power to platform (cable and outlets only)	110v cable
Circular Camera cage option	No
Lighting rig option	No
Camera pod option	No
Camera cable	No
Max operating windspeed	12.5m/s

LICENCE REQUIREMENTS

Vehicle driving licence type	C1
Operator Trained Level IPAF	1b
Self Drive option	Yes

Operating Noise level	<85Db
Operating temp range	+5° to +40°C
Manufacturer	Ascendant
Alternative machines	T20GS / T20HC / T20K / T20M / T21JC



WORKING ENVELOPE

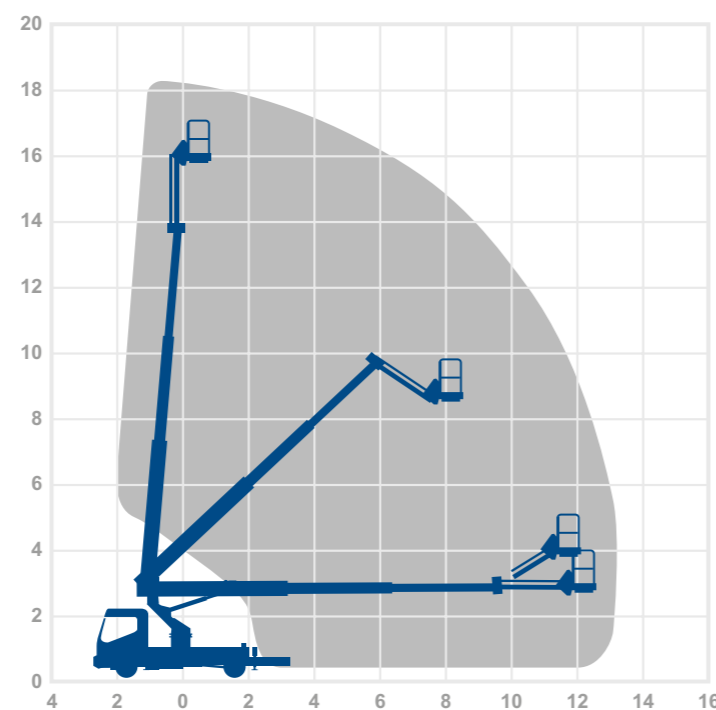

* (On standard spreader pads) these typical ground forces are based on the units standard size pad, the forces can be further reduced by scaling up the pad size.

0345 745 0000
nationwideplatforms.co.uk

T18ASH

Specification

Working Height (m)
18.0

Max Horizontal Outreach (m)
13.0

WORKING CAPABILITIES

Working Height	18.0m
Max Horizontal Outreach	13.0m
Max Horizontal Outreach (full SWL)	13.0m
Max Reach below 0m (negative envelope)	N/A
Platform/cage size	1.4m x 0.73m
Extending cage	No
Operational Full Width	3.8m
Minimum Operational width (straight down jacking)	2.3m

MACHINE DIMENSIONS

Overall travel Length	7.0m
Overall travel Height	3.0m
Overall travel Width	2.1m
Max SWL	230kg
Gross vehicle weight class	5000kg

MACHINE ATTRIBUTES

4 wheel drive	No
Number of axles	2
Rear steer	No
Articulated boom / Stick boom	Stick
Platform height	17.0m
One sided jacking	2.8m
Jacking type	H Frame
Point load Front / Rear	50kN/50kN
Typical ground pressure*	3.1kgf/cm ²
Left or Right hand drive	Right

ADDITIONAL FUNCTIONALITY

Rotating cage	Yes
Earthing Cable	No
Jib Boom	Yes
Power to platform (cable and outlets only)	110v cable
Circular Camera cage option	No
Lighting rig option	No
Camera pod option	No
Camera cable	No
Max operating windspeed	12.5m/s

LICENCE REQUIREMENTS

Vehicle driving licence type	Car if passed before 1997, special if after
Operator Trained Level IPAF	1b
Self Drive option	Yes

Operating Noise level	<85Db
Operating temp range	+5° to +40°C
Manufacturer	Ascendant
Alternative machines	T20GS / T20HC / T20K / T20M / T21JC



WORKING ENVELOPE

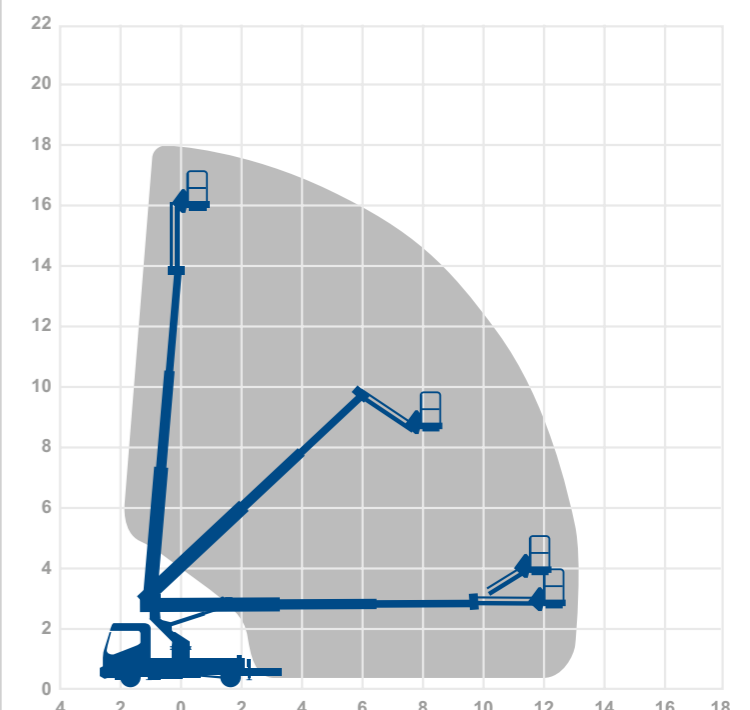

* (On standard spreader pads) these typical ground forces are based on the units standard size pad, the forces can be further reduced by scaling up the pad size.

0345 745 0000
nationwideplatforms.co.uk

T20C Specification



Working Height (m)
20.0

Max Horizontal Outreach (m)
8.0

WORKING CAPABILITIES	
Working Height	20.0m
Max Horizontal Outreach	8.0m
Max Horizontal Outreach (full SWL)	8.0m
Max Reach below 0m (negative envelope)	N/A
Platform/cage size	1.4m x 0.7m
Extending cage	No
Operational Full Width	2.9m
Minimum Operational width (straight down jacking)	2.9m

MACHINE DIMENSIONS	
Overall travel Length	6.55m
Overall travel Height	2.9m
Overall travel Width	2.1m
Max SWL	200kg
Gross vehicle weight class	3500kg

MACHINE ATTRIBUTES	
4 wheel drive	No
Number of axles	2
Rear steer	No
Articulated boom / Stick boom	Articulated
Platform height	19.0m
One sided jacking	N/A
Jacking type	A Frame
Point load Front / Rear	28kN/28kN
Typical ground pressure*	1.7kgf/cm ²
Left or Right hand drive	Right

ADDITIONAL FUNCTIONALITY	
Rotating cage	Yes
Earthing Cable	No
Jib Boom	No
Power to platform (cable and outlets only)	110v cable
Circular Camera cage option	No
Lighting rig option	No
Camera pod option	No
Camera cable	No
Max operating windspeed	12.5m/s

LICENCE REQUIREMENTS	
Vehicle driving licence type	C1
Operator Trained Level IPAF	1b
Self Drive option	Yes

Operating Noise level	<85Db
Operating temp range	+5° to +40°C
Manufacturer	CTE
Alternative machines	T20GS / T20K / T20M / T21JC

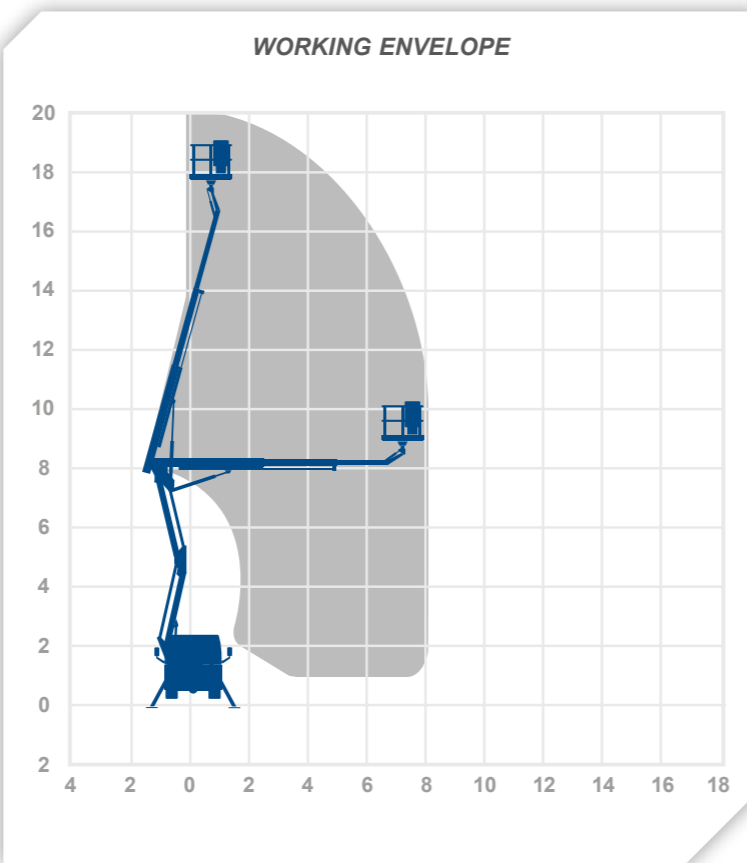

* (On standard spreader pads) these typical ground forces are based on the units standard size pad, the forces can be further reduced by scaling up the pad size.

0345 745 0000
nationwideplatforms.co.uk

T20HC Specification



Working Height (m)
20.0

Max Horizontal Outreach (m)
9.0

WORKING CAPABILITIES	
Working Height	20.0m
Max Horizontal Outreach	9.0m
Max Horizontal Outreach (full SWL)	9.0m
Max Reach below 0m (negative envelope)	N/A
Platform/cage size	1.4m x 0.7m
Extending cage	No
Operational Full Width	2.93m
Minimum Operational width (straight down jacking)	2.93m

MACHINE DIMENSIONS	
Overall travel Length	6.76m
Overall travel Height	2.5m
Overall travel Width	2.1m
Max SWL	300kg
Gross vehicle weight class	3500kg

MACHINE ATTRIBUTES	
4 wheel drive	No
Number of axles	2
Rear steer	No
Articulated boom / Stick boom	Articulated
Platform height	19.0m
One sided jacking	N/A
Jacking type	H Frame
Point load Front / Rear	28kN/28kN
Typical ground pressure*	1.7kgf/cm ²
Left or Right hand drive	Right

ADDITIONAL FUNCTIONALITY	
Rotating cage	Yes
Earthing Cable	No
Jib Boom	Yes
Power to platform (cable and outlets only)	110v cable
Circular Camera cage option	No
Lighting rig option	No
Camera pod option	No
Camera cable	No
Max operating windspeed	12.5m/s

LICENCE REQUIREMENTS	
Vehicle driving licence type	C1
Operator Trained Level IPAF	1b
Self Drive option	Yes

Operating Noise level	<85Db
Operating temp range	+5° to +40°C
Manufacturer	CTE
Alternative machines	T20GS / T20K / T20M / T21JC

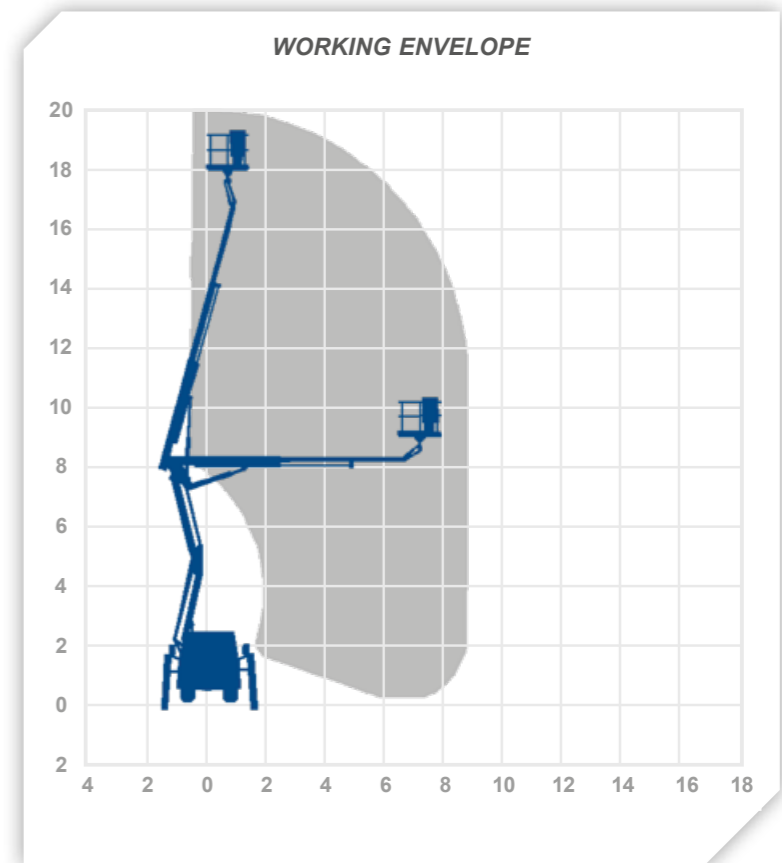

* (On standard spreader pads) these typical ground forces are based on the units standard size pad, the forces can be further reduced by scaling up the pad size.

0345 745 0000
nationwideplatforms.co.uk

T20GS Specification



Working Height (m)
20.0

Max Horizontal Outreach (m)
8.2

WORKING CAPABILITIES	
Working Height	20.0m
Max Horizontal Outreach	8.2m
Max Horizontal Outreach (full SWL)	8.2m
Max Reach below 0m (negative envelope)	N/A
Platform/cage size	1.4m x 0.7m
Extending cage	No
Operational Full Width	2.3m
Minimum Operational width (straight down jacking)	2.3m

MACHINE DIMENSIONS	
Overall travel Length	7.46m
Overall travel Height	2.77m
Overall travel Width	2.1m
Max SWL	280kg
Gross vehicle weight class	3500kg

MACHINE ATTRIBUTES	
4 wheel drive	No
Number of axles	2
Rear steer	No
Articulated boom / Stick boom	Articulated
Platform height	19.0m
One sided jacking	N/A
Jacking type	A Frame
Point load Front / Rear	25kN/18kN
Typical ground pressure*	F1.8 -R1.2kgf/cm ²
Left or Right hand drive	Right

ADDITIONAL FUNCTIONALITY	
Rotating cage	Yes
Earthing Cable	No
Jib Boom	No
Power to platform (cable and outlets only)	110v cable
Circular Camera cage option	No
Lighting rig option	No
Camera pod option	No
Camera cable	No
Max operating windspeed	12.5m/s

LICENCE REQUIREMENTS	
Vehicle driving licence type	C1
Operator Trained Level IPAF	1b
Self Drive option	Yes

Operating Noise level	<85Db
Operating temp range	+5° to +40°C
Manufacturer	GSR
Alternative machines	T20HC / T20K / T20M / T21JC

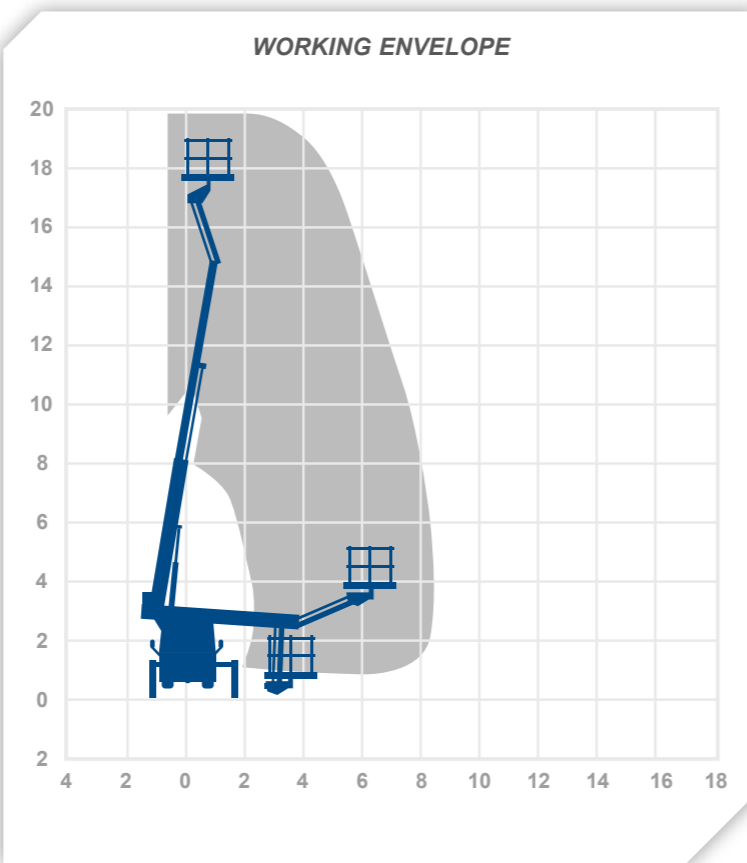

* (On standard spreader pads) these typical ground forces are based on the units standard size pad, the forces can be further reduced by scaling up the pad size.

0345 745 0000
nationwideplatforms.co.uk

T20M Specification



Working Height (m)
20.0

Max Horizontal Outreach (m)
11.0

WORKING CAPABILITIES	
Working Height	20.0m
Max Horizontal Outreach	11.0m (80kg)
Max Horizontal Outreach (full SWL)	8.6m
Max Reach below 0m (negative envelope)	2.0m
Platform/cage size	1.4m x 0.7m
Extending cage	No
Operational Full Width	3.4m
Minimum Operational width (straight down jacking)	2.5m

MACHINE DIMENSIONS	
Overall travel Length	7.65m
Overall travel Height	3.0m
Overall travel Width	2.1m
Max SWL	250kg
Gross vehicle weight class	3500kg

MACHINE ATTRIBUTES	
4 wheel drive	No
Number of axles	2
Rear steer	No
Articulated boom / Stick boom	Stick boom
Platform height	18.1m
One sided jacking	N/A
Jacking type	H Frame
Point load Front / Rear	30kN/19kN
Typical ground pressure*	F1.8- R1.2kgf/cm ²
Left or Right hand drive	Right

ADDITIONAL FUNCTIONALITY	
Rotating cage	Yes
Earthing Cable	No
Jib Boom	Yes
Power to platform (cable and outlets only)	110v cable
Circular Camera cage option	No
Lighting rig option	No
Camera pod option	No
Camera cable	No
Max operating windspeed	12.5m/s

LICENCE REQUIREMENTS	
Vehicle driving licence type	C1
Operator Trained Level IPAF	1b
Self Drive option	Yes

Operating Noise level	<85Db
Operating temp range	+5° to +40°C
Manufacturer	Multitel
Alternative machines	T20GS / T20HC / T20K / T21JC

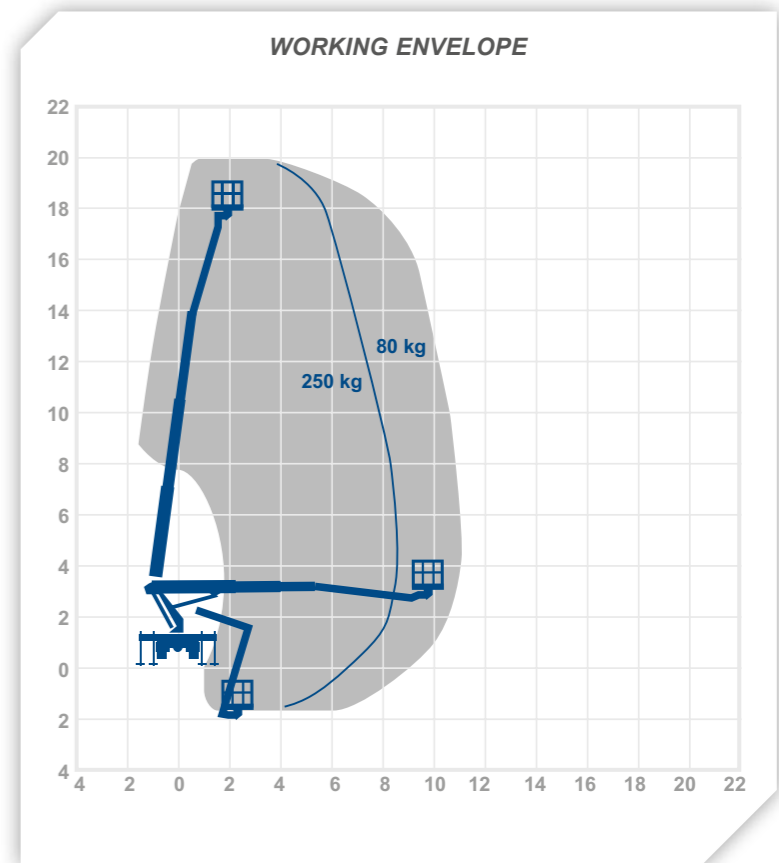

* (On standard spreader pads) these typical ground forces are based on the units standard size pad, the forces can be further reduced by scaling up the pad size.

† Depending on load, angle of rotation and outrigger configuration.

0345 745 0000
nationwideplatforms.co.uk

T21JC

Specification

Working Height (m)
21.0

Max Horizontal Outreach (m)
10.0

WORKING CAPABILITIES

Working Height	21.0m
Max Horizontal Outreach	10.0m
Max Horizontal Outreach (full SWL)	10.0m
Max Reach below 0m (negative envelope)	N/A
Platform/cage size	1.4m x 0.7m
Extending cage	No
Operational Full Width	2.9m
Minimum Operational width (straight down jacking)	2.9m

MACHINE DIMENSIONS

Overall travel Length	6.8m
Overall travel Height	2.6m
Overall travel Width	2.1m
Max SWL	280kg
Gross vehicle weight class	3500kg

MACHINE ATTRIBUTES

4 wheel drive	No
Number of axles	2
Rear steer	No
Articulated boom / Stick boom	Articulated
Platform height	20.0m
One sided jacking	N/A
Jacking type	A Frame
Point load Front / Rear	28kN/28kN
Typical ground pressure*	1.7kgf/cm ²
Left or Right hand drive	Right

ADDITIONAL FUNCTIONALITY

Rotating cage	Yes
Earthing Cable	No
Jib Boom	Yes
Power to platform (cable and outlets only)	110v cable
Circular Camera cage option	No
Lighting rig option	No
Camera pod option	No
Camera cable	No
Max operating windspeed	12.5m/s

LICENCE REQUIREMENTS

Vehicle driving licence type	C1
Operator Trained Level IPAF	1b
Self Drive option	Yes

Operating Noise level	<85Db
Operating temp range	+5° to +40°C
Manufacturer	CTE
Alternative machines	T20GS / T20HC / T20K / T20M



WORKING ENVELOPE

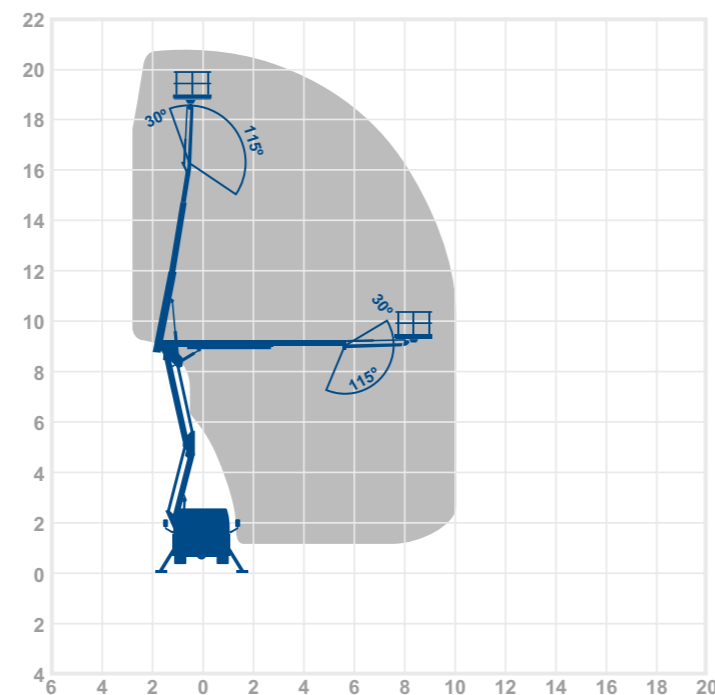

* (On standard spreader pads) these typical ground forces are based on the units standard size pad, the forces can be further reduced by scaling up the pad size.

0345 745 0000
nationwideplatforms.co.uk

T22AS

Specification

Working Height (m)
22.0

Max Horizontal Outreach (m)
17.5

WORKING CAPABILITIES

Working Height	22.0m
Max Horizontal Outreach	17.5m
Max Horizontal Outreach (full SWL)	17.5m
Max Reach below 0m (negative envelope)	N/A
Platform/cage size	1.8m x 1.1m
Extending cage	No
Operational Full Width	4.5m
Minimum Operational width (straight down jacking)	2.5m

MACHINE DIMENSIONS

Overall travel Length	9.2m
Overall travel Height	3.5m
Overall travel Width	2.4m
Max SWL	280kg
Gross vehicle weight class	7500kg

MACHINE ATTRIBUTES

4 wheel drive	No
Number of axles	2
Rear steer	No
Articulated boom / Stick boom	Stick boom
Platform height	21.0m
One sided jacking	3.6m
Jacking type	H Frame
Point load Front / Rear	60kN/60kN
Typical ground pressure*	2.4kgf/cm ²
Left or Right hand drive	Right

ADDITIONAL FUNCTIONALITY

Rotating cage	Yes
Earthing Cable	No
Jib Boom	Yes
Power to platform (cable and outlets only)	110v cable
Circular Camera cage option	No
Lighting rig option	No
Camera pod option	Yes
Camera cable	No
Max operating windspeed	12.5m/s

LICENCE REQUIREMENTS

Vehicle driving licence type	7.5t
Operator Trained Level IPAF	1b
Self Drive option	Yes

Operating Noise level	<85Db
Operating temp range	+5° to +40°C
Manufacturer	Ascendant
Alternative machines	T22GS / T22GSH / T26GS / T26C



WORKING ENVELOPE

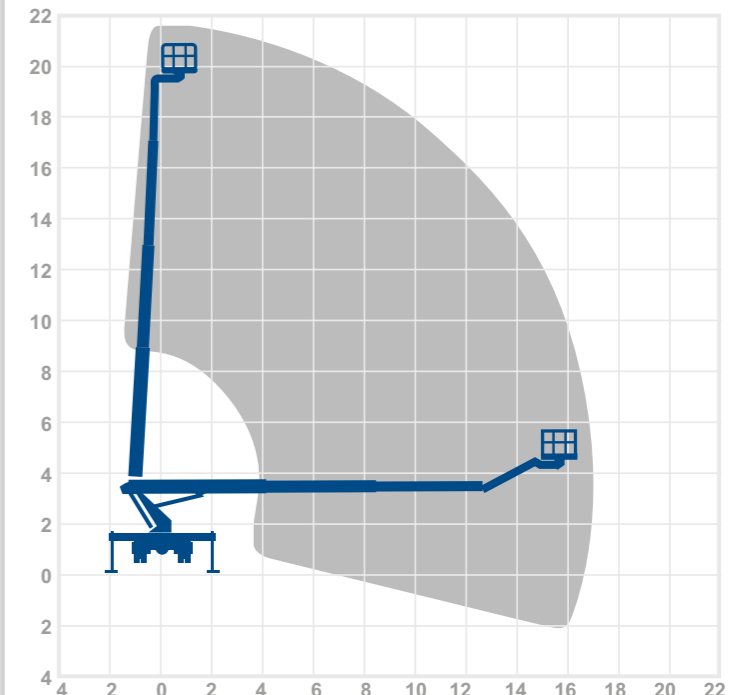

* (On standard spreader pads) these typical ground forces are based on the units standard size pad, the forces can be further reduced by scaling up the pad size.

0345 745 0000
nationwideplatforms.co.uk

T22GS Specification



Working Height (m)
22.0

Max Horizontal Outreach (m)
17.7

WORKING CAPABILITIES	
Working Height	22.0m
Max Horizontal Outreach	17.7m
Max Horizontal Outreach (full SWL)	17.7m
Max Reach below 0m (negative envelope)	N/A
Platform/cage size	1.8m x 0.8m
Extending cage	No
Operational Full Width	4.5m
Minimum Operational width (straight down jacking)	2.5m

MACHINE DIMENSIONS	
Overall travel Length	8.7m
Overall travel Height	3.55m
Overall travel Width	2.5m
Max SWL	280kg
Gross vehicle weight class	7500kg

MACHINE ATTRIBUTES	
4 wheel drive	No
Number of axles	2
Rear steer	No
Articulated boom / Stick boom	Stick boom
Platform height	21.0m
One sided jacking	3.6m
Jacking type	H Frame
Point load Front / Rear	60kN/60kN
Typical ground pressure*	2.4kgf/cm ²
Left or Right hand drive	Right

ADDITIONAL FUNCTIONALITY	
Rotating cage	Yes
Earthing Cable	No
Jib Boom	Yes
Power to platform (cable and outlets only)	110v cable
Circular Camera cage option	No
Lighting rig option	No
Camera pod option	Yes
Camera cable	No
Max operating windspeed	12.5m/s

LICENCE REQUIREMENTS	
Vehicle driving licence type	7.5t
Operator Trained Level IPAF	1b
Self Drive option	Yes

Operating Noise level	<85Db
Operating temp range	+5° to +40°C
Manufacturer	GSR
Alternative machines	T22GSH

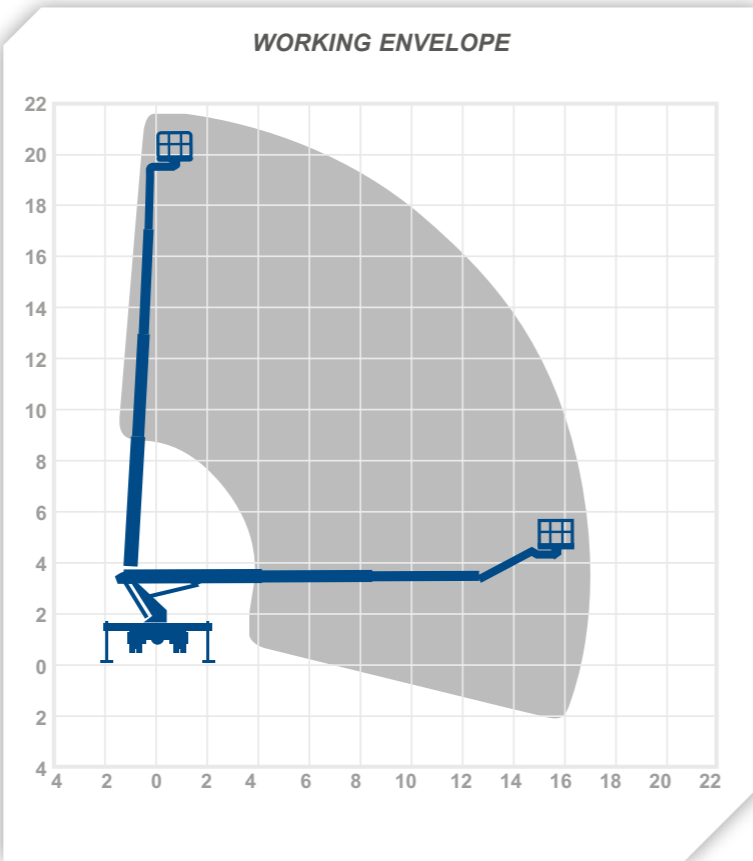

* (On standard spreader pads) these typical ground forces are based on the units standard size pad, the forces can be further reduced by scaling up the pad size.

0345 745 0000
nationwideplatforms.co.uk

T26GS Specification



Working Height (m)
26.0

Max Horizontal Outreach (m)
12.0

WORKING CAPABILITIES	
Working Height	26.0m
Max Horizontal Outreach	12.0m
Max Horizontal Outreach (full SWL)	14.0m
Max Reach below 0m (negative envelope)	N/A
Platform/cage size	1.4m x 0.7m
Extending cage	No
Operational Full Width	3.5m
Minimum Operational width (straight down jacking)	3.5m

MACHINE DIMENSIONS	
Overall travel Length	7.8m
Overall travel Height	3.6m
Overall travel Width	2.5m
Max SWL	280kg
Gross vehicle weight class	7500kg

MACHINE ATTRIBUTES	
4 wheel drive	No
Number of axles	2
Rear steer	No
Articulated boom / Stick boom	Articulated
Platform height	26.0m
One sided jacking	N/A
Jacking type	H Frame
Point load Front / Rear	60kN/60kN
Typical ground pressure*	2.4kgf/cm ²
Left or Right hand drive	Right

ADDITIONAL FUNCTIONALITY	
Rotating cage	Yes
Earthing Cable	No
Jib Boom	No
Power to platform (cable and outlets only)	110v cable
Circular Camera cage option	No
Lighting rig option	No
Camera pod option	No
Camera cable	No
Max operating windspeed	12.5m/s

LICENCE REQUIREMENTS	
Vehicle driving licence type	7.5t
Operator Trained Level IPAF	1b
Self Drive option	Yes

Operating Noise level	<85Db
Operating temp range	+5° to +40°C
Manufacturer	GSR
Alternative machines	T26C / T27R

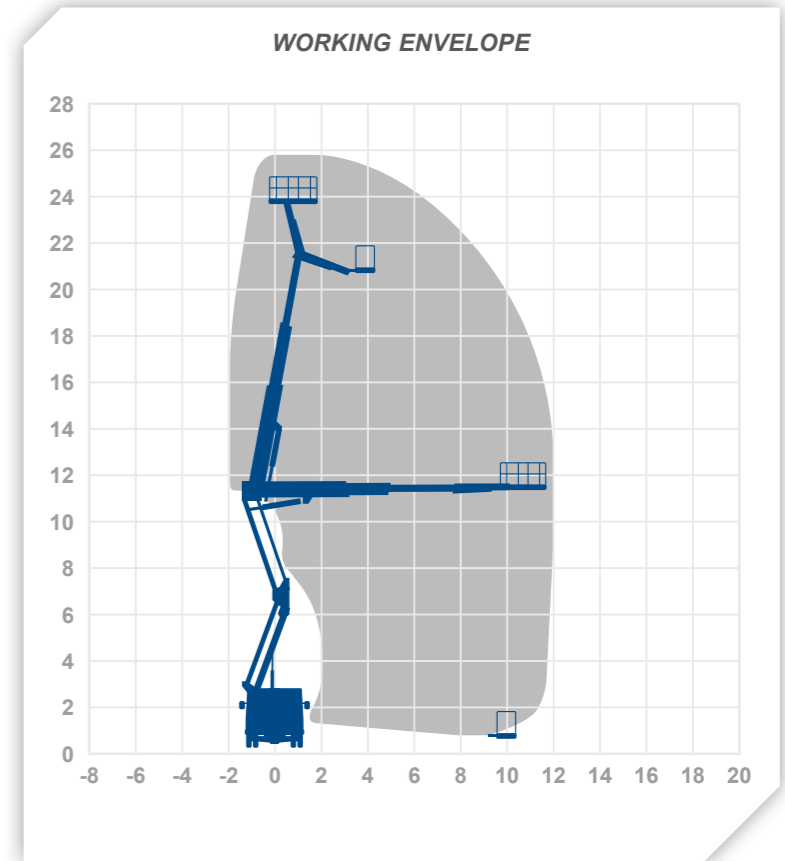

* (On standard spreader pads) these typical ground forces are based on the units standard size pad, the forces can be further reduced by scaling up the pad size.

0345 745 0000
nationwideplatforms.co.uk

Operator driven vehicle mounted platforms

Typical applications

- Construction
- TV & Film Production
- Festivals, Sports & Events
- Signage
- Utilities
- Telecoms

Range attributes

- Working heights from 13 to 90 metres
- All vehicles available with our highly experienced IPAF & OEM trained operators
- Most cost-effective method of access for short term hires
- Large fleet of 4-wheel drive machines, ideal for off road applications
- Narrow jacking and zero tail swing models available
- Safe working loads up to 700kg, ideal for fitting of our specialist sector attachments for Telecoms & Media clients

Operator
Driven

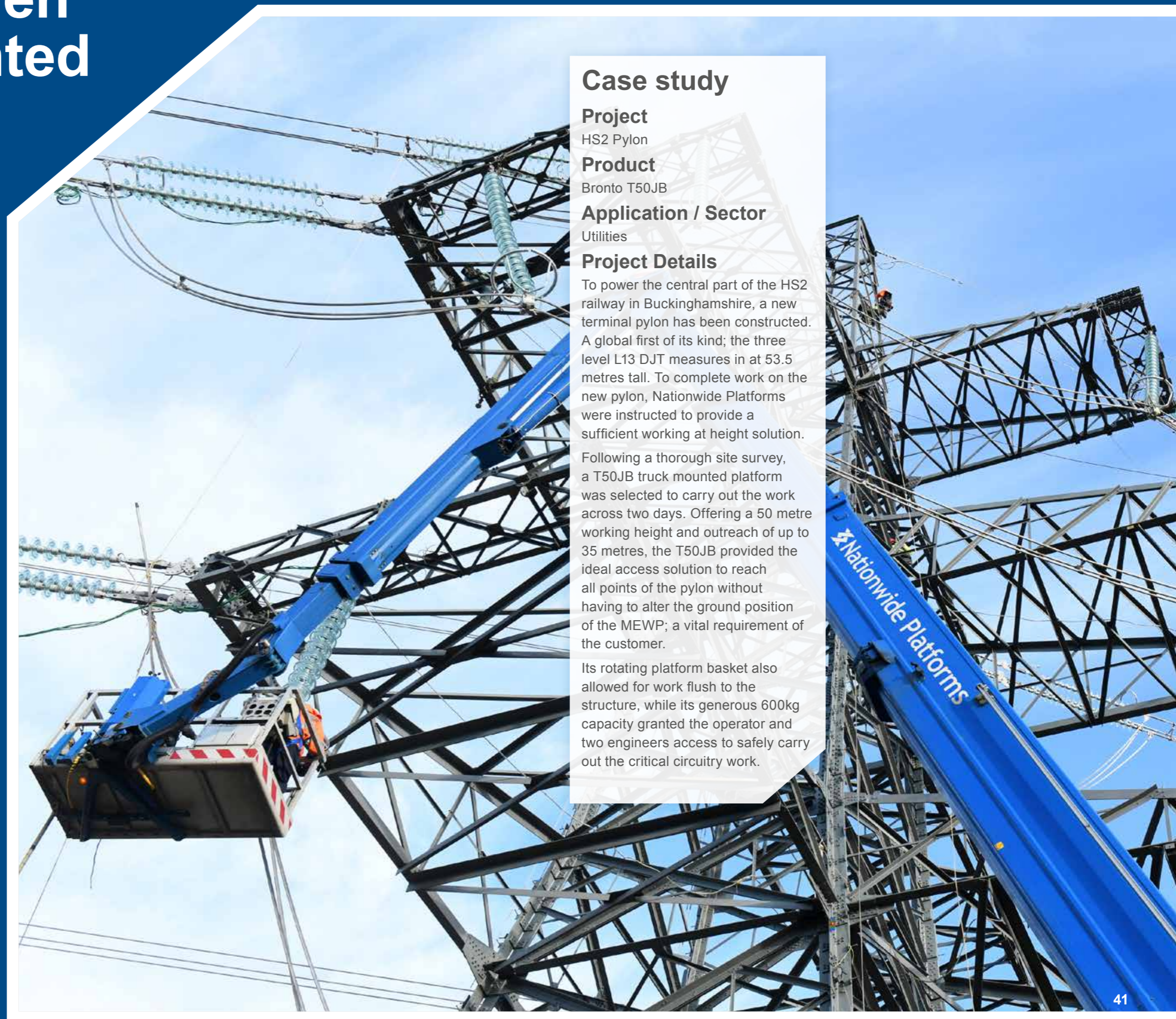

Case study

Project

HS2 Pylon

Product

Bronto T50JB

Application / Sector

Utilities

Project Details

To power the central part of the HS2 railway in Buckinghamshire, a new terminal pylon has been constructed. A global first of its kind; the three level L13 DJT measures in at 53.5 metres tall. To complete work on the new pylon, Nationwide Platforms were instructed to provide a sufficient working at height solution.

Following a thorough site survey, a T50JB truck mounted platform was selected to carry out the work across two days. Offering a 50 metre working height and outreach of up to 35 metres, the T50JB provided the ideal access solution to reach all points of the pylon without having to alter the ground position of the MEWP; a vital requirement of the customer.

Its rotating platform basket also allowed for work flush to the structure, while its generous 600kg capacity granted the operator and two engineers access to safely carry out the critical circuitry work.

T22GSH

Specification



Working Height (m)
22.0

Max Horizontal Outreach (m)
17.7

WORKING CAPABILITIES	
Working Height	22.0m
Max Horizontal Outreach	17.7m
Max Horizontal Outreach (full SWL)	17.7m
Max Reach below 0m (negative envelope)	N/A
Platform/cage size	1.8m x 0.8m
Extending cage	No
Operational Full Width	4.5m
Minimum Operational width (straight down jacking)	2.5m

MACHINE DIMENSIONS	
Overall travel Length	8.7m
Overall travel Height	3.55m
Overall travel Width	2.5m
Max SWL	280kg
Gross vehicle weight class	8200kg

MACHINE ATTRIBUTES	
4 wheel drive	No
Number of axles	2
Rear steer	No
Articulated boom / Stick boom	Stick boom
Platform height	21.0m
One sided jacking	3.6m
Jacking type	H Frame
Point load Front / Rear	60kN/60kN
Typical ground pressure*	2.4kgf/cm ²
Left or Right hand drive	Right

ADDITIONAL FUNCTIONALITY	
Rotating cage	Yes
Earthing Cable	No
Jib Boom	Yes
Power to platform (cable and outlets only)	110v cable
Circular Camera cage option	No
Lighting rig option	No
Camera pod option	Yes
Camera cable	No
Max operating windspeed	12.5m/s

LICENCE REQUIREMENTS	
Vehicle driving licence type	HGV
Operator Trained Level IPAF	1b
Self Drive option	No

Operating Noise level	<85DB
Operating temp range	+5° to +40°C
Manufacturer	GSR
Alternative machines	T28RX / T33HH

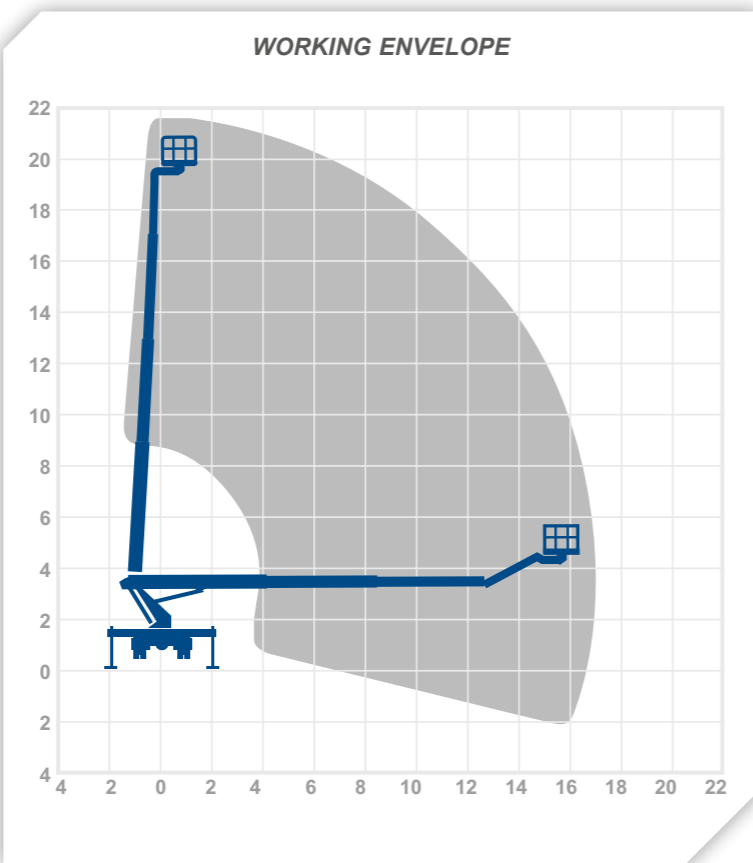

* (On standard spreader pads) these typical ground forces are based on the units standard size pad, the forces can be further reduced by scaling up the pad size.

0345 745 0000
nationwideplatforms.co.uk

T26CX

Specification



Working Height (m)
26.0

Max Horizontal Outreach (m)
12.5

WORKING CAPABILITIES	
Working Height	26.0m
Max Horizontal Outreach	12.5m
Max Horizontal Outreach (full SWL)	12.5m
Max Reach below 0m (negative envelope)	N/A
Platform/cage size	1.4m x 0.7m
Extending cage	No
Operational Full Width	3.12m
Minimum Operational width (straight down jacking)	3.12m

MACHINE DIMENSIONS	
Overall travel Length	7.45m
Overall travel Height	3.9m
Overall travel Width	2.6m
Max SWL	230kg
Gross vehicle weight class	14000kg

MACHINE ATTRIBUTES	
4 wheel drive	Yes
Number of axles	2
Rear steer	No
Articulated boom / Stick boom	Articulated
Platform height	24.0m
One sided jacking	N/A
Jacking type	A Frame
Point load Front / Rear	140kN/140kN
Typical ground pressure*	2.5kgf/cm ²
Left or Right hand drive	Right

ADDITIONAL FUNCTIONALITY	
Rotating cage	Yes
Earthing Cable	No
Jib Boom	No
Power to platform (cable and outlets only)	110v cable
Circular Camera cage option	No
Lighting rig option	No
Camera pod option	No
Camera cable	No
Max operating windspeed	12.5m/s

LICENCE REQUIREMENTS	
Vehicle driving licence type	HGV
Operator Trained Level IPAF	1b
Self Drive option	No

Operating Noise level	<85Db
Operating temp range	-25° to +40°C
Manufacturer	CTE
Alternative machines	T28RX

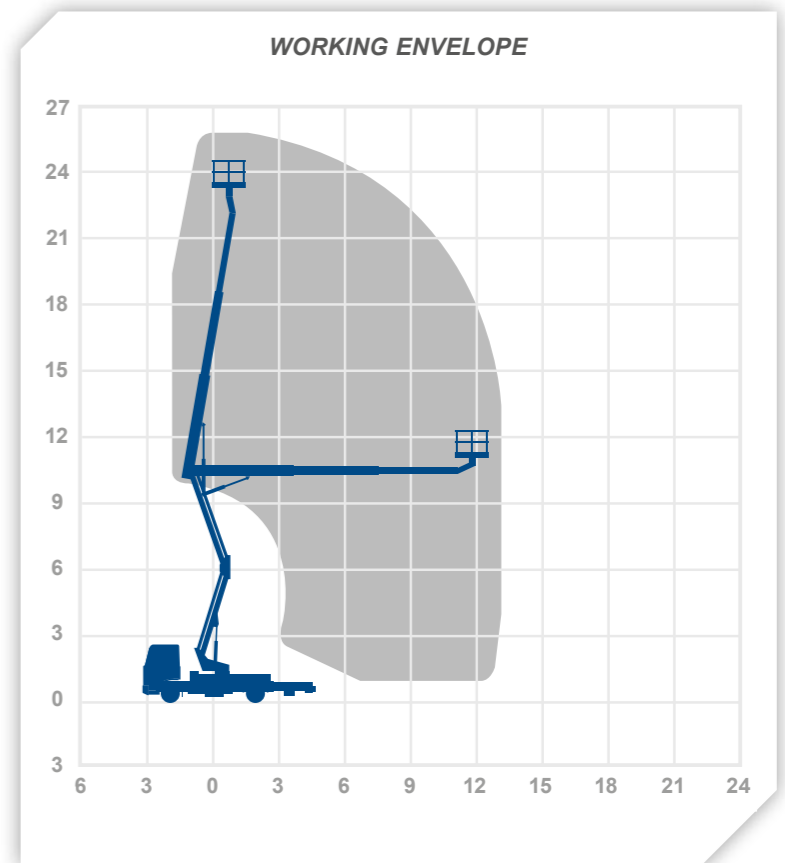

* (On standard spreader pads) these typical ground forces are based on the units standard size pad, the forces can be further reduced by scaling up the pad size.

0345 745 0000
nationwideplatforms.co.uk

T27R

Specification



Working Height (m)
27.0

Max Horizontal Outreach (m)
21.0

WORKING CAPABILITIES	
Working Height	27.0m
Max Horizontal Outreach	21.0m (100kg)
Max Horizontal Outreach (full SWL)	16.0m
Max Reach below 0m (negative envelope)	N/A
Platform/cage size	1.85m x 1.0m
Extending cage	No
Operational Full Width	5.1m
Minimum Operational width (straight down jacking)	2.5m

MACHINE DIMENSIONS	
Overall travel Length	7.87m
Overall travel Height	3.3m
Overall travel Width	2.54m
Max SWL†	320kg
Gross vehicle weight class	7500kg

MACHINE ATTRIBUTES	
4 wheel drive	No
Number of axles	2
Rear steer	No
Articulated boom / Stick boom	Stick boom
Platform height	25.0m
One sided jacking	3.8m
Jacking type	H Frame
Point load Front / Rear	72kN/55kN
Typical ground pressure*	F2.8-R2.2 kgf/cm ²
Left or Right hand drive	Left

ADDITIONAL FUNCTIONALITY	
Rotating cage	Yes
Earthing Cable	No
Jib Boom	Yes
Power to platform (cable and outlets only)	110v cable
Circular Camera cage option	No
Lighting rig option	No
Camera pod option	Yes
Camera cable	No
Max operating windspeed	12.5m/s

LICENCE REQUIREMENTS	
Vehicle driving licence type	7.5t
Operator Trained Level IPAF	1b
Self Drive option	No

Operating Noise level	<85Db
Operating temp range	-25° to +40°C
Manufacturer	Ruthmann
Alternative machines	T26GS / T26C

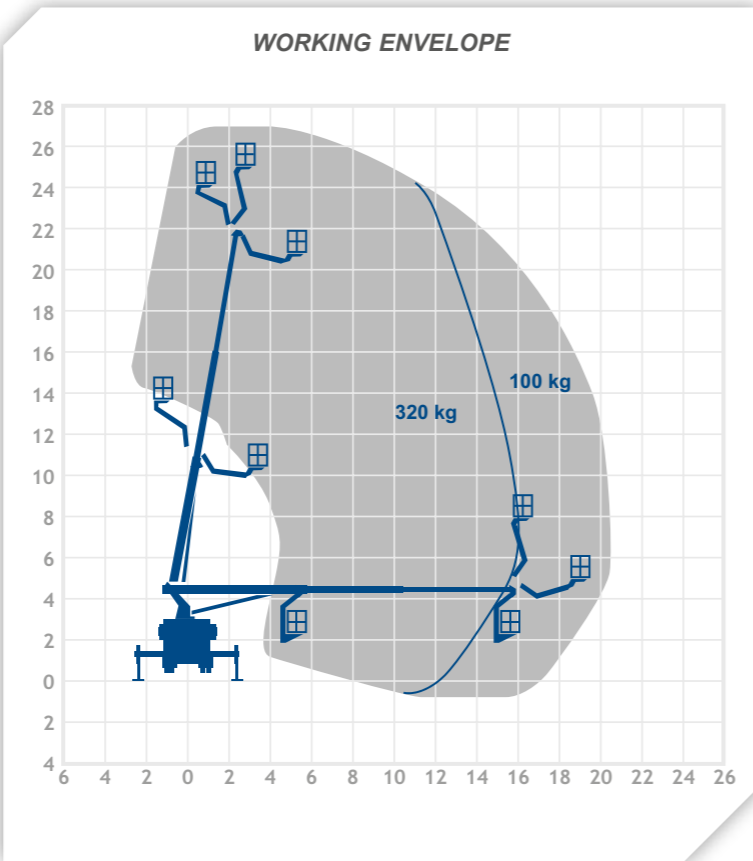

* (On standard spreader pads) these typical ground forces are based on the units standard size pad, the forces can be further reduced by scaling up the pad size.
† Depending on load, angle of rotation and outrigger configuration.

0345 745 0000
nationwideplatforms.co.uk

T28RX

Specification



Working Height (m)
28.0

Max Horizontal Outreach (m)
21.3

WORKING CAPABILITIES	
Working Height	28.0m
Max Horizontal Outreach	21.3m (100kg)
Max Horizontal Outreach (full SWL)	16.0m
Max Reach below 0m (negative envelope)	N/A
Platform/cage size	1.7m x 0.86m
Extending cage	No
Operational Full Width	3.8m
Minimum Operational width (straight down jacking)	2.5m

MACHINE DIMENSIONS	
Overall travel Length	8.12m
Overall travel Height	3.8m
Overall travel Width	2.5m
Max SWL†	320kg
Gross vehicle weight class	11000kg

MACHINE ATTRIBUTES	
4 wheel drive	Yes
Number of axles	2
Rear steer	No
Articulated boom / Stick boom	Stick boom
Platform height	26.5m
One sided jacking	3.1m
Jacking type	H Frame
Point load Front / Rear	110kN/50kN
Typical ground pressure*	F3.0-R1.4 kgf/cm ²
Left or Right hand drive	Right

ADDITIONAL FUNCTIONALITY	
Rotating cage	Yes
Earthing Cable	No
Jib Boom	Yes
Power to platform (cable and outlets only)	110v cable
Circular Camera cage option	No
Lighting rig option	No
Camera pod option	No
Camera cable	No
Max operating windspeed	12.5m/s

LICENCE REQUIREMENTS	
Vehicle driving licence type	HGV
Operator Trained Level IPAF	1b
Self Drive option	No

Operating Noise level	<85Db
Operating temp range	-25° to +40°C
Manufacturer	Ruthmann
Alternative machines	N/A

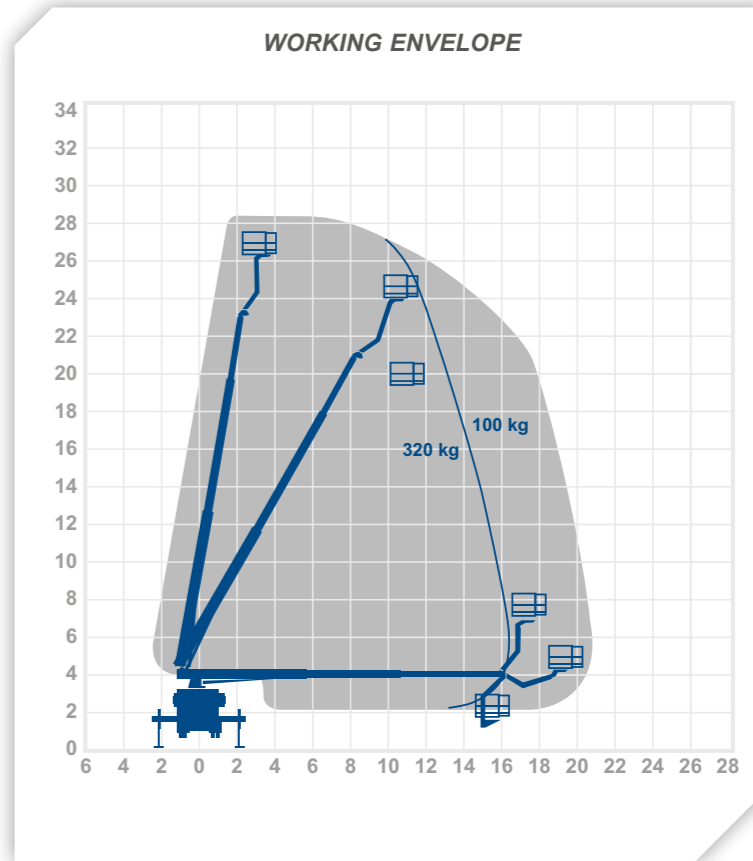

* (On standard spreader pads) these typical ground forces are based on the units standard size pad, the forces can be further reduced by scaling up the pad size.
† Depending on load, angle of rotation and outrigger configuration.

0345 745 0000
nationwideplatforms.co.uk

T33RH

Specification



Working Height (m)
33.0

Max Horizontal Outreach (m)
21.2

WORKING CAPABILITIES	
Working Height	33.0m
Max Horizontal Outreach	21.2m (100kg)
Max Horizontal Outreach (full SWL)	16.5m
Max Reach below 0m (negative envelope)	N/A
Platform/cage size	1.7m x 0.86m
Extending cage	No
Operational Full Width	5.32m
Minimum Operational width (straight down jacking)	2.53m

MACHINE DIMENSIONS	
Overall travel Length	8.7m
Overall travel Height	3.56m
Overall travel Width	2.5m
Max SWL†	320kg
Gross vehicle weight class	8600kg

MACHINE ATTRIBUTES	
4 wheel drive	No
Number of axles	3
Rear steer	No
Articulated boom / Stick boom	Stick boom
Platform height	31.0m
One sided jacking	3.9m
Jacking type	H Frame
Point load Front / Rear	56kN/42kN
Typical ground pressure*	F2.2-R1.7 kgf/cm ²
Left or Right hand drive	Right

ADDITIONAL FUNCTIONALITY	
Rotating cage	Yes
Earthing Cable	No
Jib Boom	Yes
Power to platform (cable and outlets only)	110v cable
Circular Camera cage option	No
Lighting rig option	No
Camera pod option	No
Camera cable	No
Max operating windspeed	12.5m/s

LICENCE REQUIREMENTS	
Vehicle driving licence type	HGV
Operator Trained Level IPAF	1b
Self Drive option	No

Operating Noise level	<85Db
Operating temp range	-25° to +40°C
Manufacturer	Ruthmann
Alternative machines	T33RH / T34B / T35B

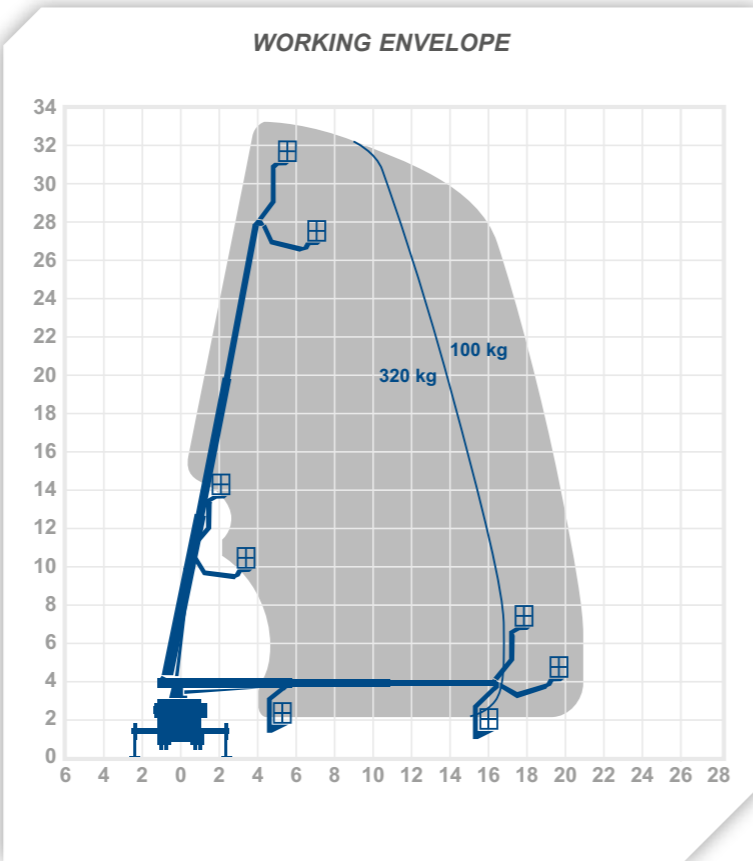

* (On standard spreader pads) these typical ground forces are based on the units standard size pad, the forces can be further reduced by scaling up the pad size.
† Depending on load, angle of rotation and outrigger configuration.

0345 745 0000
nationwideplatforms.co.uk

T33R

Specification



Working Height (m)
33.0

Max Horizontal Outreach (m)
21.2

WORKING CAPABILITIES	
Working Height	33.0m
Max Horizontal Outreach	21.2m (100kg)
Max Horizontal Outreach (full SWL)	16.5m
Max Reach below 0m (negative envelope)	N/A
Platform/cage size	1.7m x 0.86m
Extending cage	No
Operational Full Width	5.32m
Minimum Operational width (straight down jacking)	2.53m

MACHINE DIMENSIONS	
Overall travel Length	8.7m
Overall travel Height	3.56m
Overall travel Width	2.5m
Max SWL†	320kg
Gross vehicle weight class	7490kg

MACHINE ATTRIBUTES	
4 wheel drive	No
Number of axles	2
Rear steer	No
Articulated boom / Stick boom	Stick boom
Platform height	31.0m
One sided jacking	3.9m
Jacking type	H Frame
Point load Front / Rear	56kN/42kN
Typical ground pressure*	F2.2-R1.7 kgf/cm ²
Left or Right hand drive	Right

ADDITIONAL FUNCTIONALITY	
Rotating cage	Yes
Earthing Cable	No
Jib Boom	Yes
Power to platform (cable and outlets only)	110v cable
Circular Camera cage option	No
Lighting rig option	No
Camera pod option	No
Camera cable	No
Max operating windspeed	12.5m/s

LICENCE REQUIREMENTS	
Vehicle driving licence type	7.5T
Operator Trained Level IPAF	1b
Self Drive option	No

Operating Noise level	<85Db
Operating temp range	-25° to +40°C
Manufacturer	Ruthmann
Alternative machines	T33R / T34B / T35B

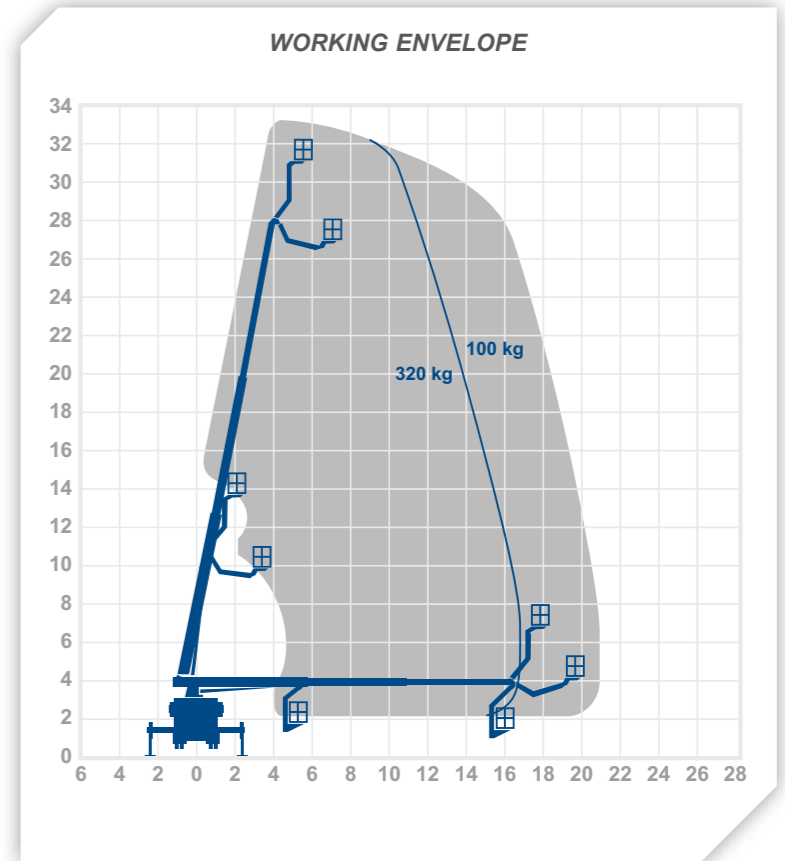

* (On standard spreader pads) these typical ground forces are based on the units standard size pad, the forces can be further reduced by scaling up the pad size.
† Depending on load, angle of rotation and outrigger configuration.

0345 745 0000
nationwideplatforms.co.uk

T37B

Specification



Working Height (m)
37.0

Max Horizontal Outreach (m)
26.0

WORKING CAPABILITIES

Working Height	37.0m
Max Horizontal Outreach	26.0m (120kg)
Max Horizontal Outreach (full SWL)	21.0m
Max Reach below 0m (negative envelope)	6.5m
Platform/cage size	2.3m x 1.05m
Extending cage	No
Operational Full Width	6.2m
Minimum Operational width (straight down jacking)	2.8m

MACHINE DIMENSIONS

Overall travel Length	10.0m
Overall travel Height	3.6m
Overall travel Width	2.5m
Max SWL†	700kg
Gross vehicle weight class	18000kg

MACHINE ATTRIBUTES

4 wheel drive	No
Number of axles	2
Rear steer	No
Articulated boom / Stick boom	Stick boom
Platform height	35.0m
One sided jacking	4.2m
Jacking type	H Frame variable
Point load Front / Rear	150kN/150kN
Typical ground pressure*	3.1kgf/cm ²
Left or Right hand drive	left

ADDITIONAL FUNCTIONALITY

Rotating cage	Yes
Earthing Cable	No
Jib Boom	Yes
Power to platform (cable and outlets only)	110v cable
Circular Camera cage option	No
Lighting rig option	No
Camera pod option	Yes
Camera cable	No
Max operating windspeed	12.5m/s

LICENCE REQUIREMENTS

Vehicle driving licence type	HGV
Operator Trained Level IPAF	1b
Self Drive option	No
Operating Noise level	<85Db
Operating temp range	-25° to +40°C
Manufacturer	Bronto
Alternative machines	T38B



WORKING ENVELOPE

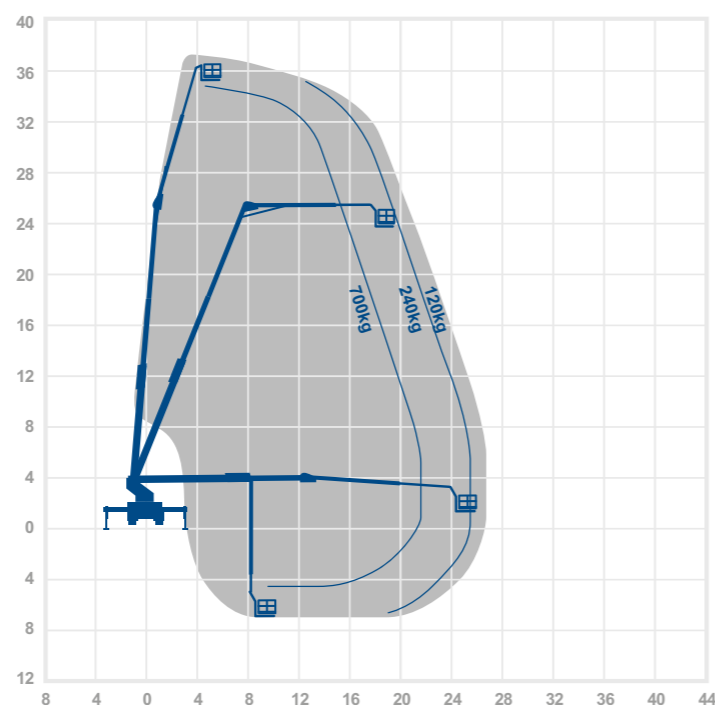

* (On standard spreader pads) these typical ground forces are based on the units standard size pad, the forces can be further reduced by scaling up the pad size.
† Depending on load, angle of rotation and outrigger configuration.

0345 745 0000
nationwideplatforms.co.uk

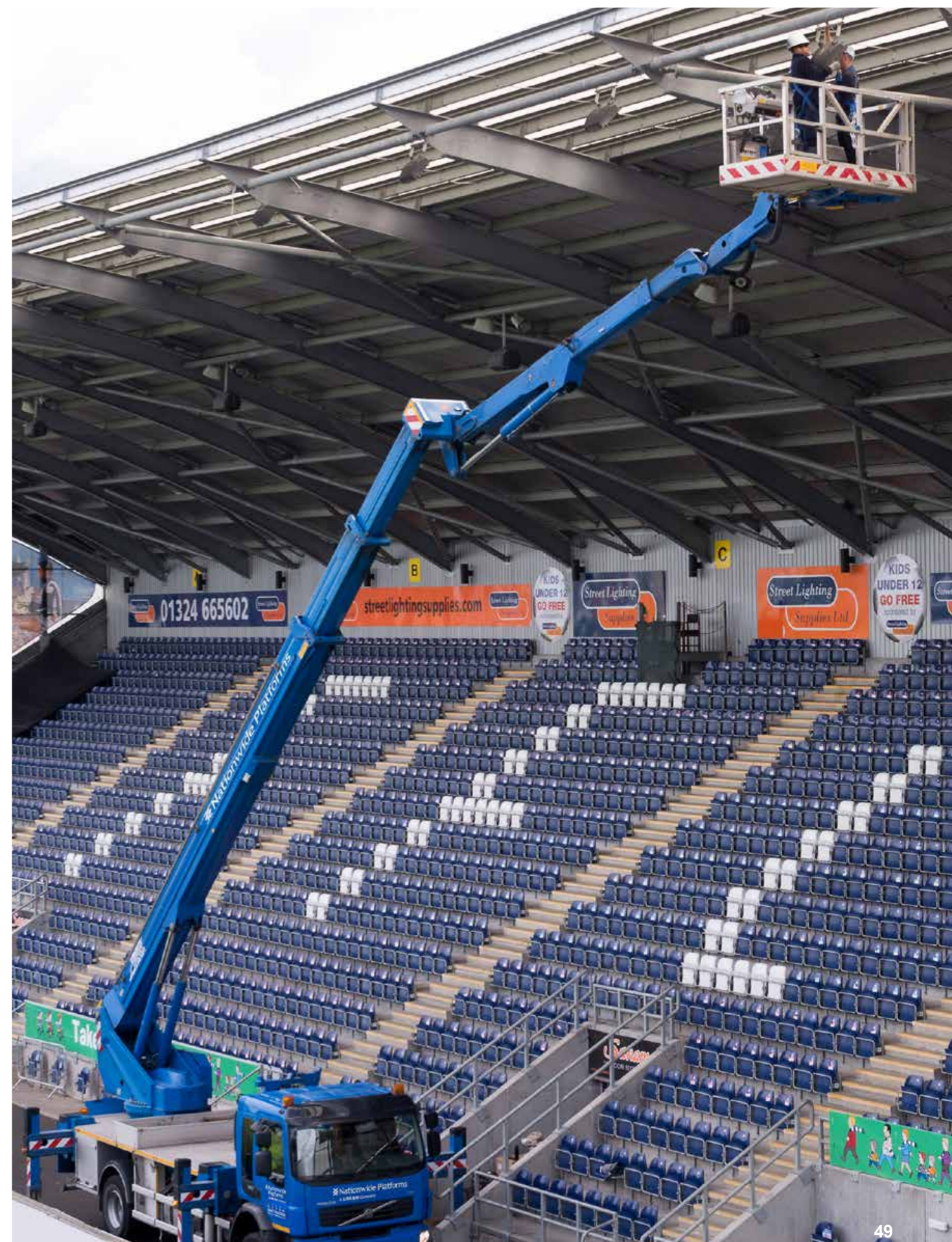

T37R

Specification



Working Height (m)
37.0

Max Horizontal Outreach (m)
30.0

WORKING CAPABILITIES	
Working Height	37.0m
Max Horizontal Outreach	30.0m (100kg)
Max Horizontal Outreach (full SWL)	21.0m
Max Reach below 0m (negative envelope)	6.0m
Platform/cage size	2.3m (3.6m) x 0.9m
Extending cage	3.6m
Operational Full Width	6.4m
Minimum Operational width (straight down jacking)	2.6m

MACHINE DIMENSIONS

Overall travel Length	8.9m
Overall travel Height	3.9m
Overall travel Width	2.55m
Max SWL†	500kg
Gross vehicle weight class	18000kg

MACHINE ATTRIBUTES

4 wheel drive	No
Number of axles	2
Rear steer	No
Articulated boom / Stick boom	Stick boom
Platform height	34.5m
One sided jacking	4.5m
Jacking type	H Frame variable
Point load Front / Rear	170kN/140kN
Typical ground pressure*	F3.5-R2.8kgf/cm²
Left or Right hand drive	Left

ADDITIONAL FUNCTIONALITY

Rotating cage	Yes
Earthing Cable	Yes
Jib Boom	Yes
Power to platform (cable and outlets only)	110v cable
Circular Camera cage option	No
Lighting rig option	No
Camera pod option	Yes
Camera cable	No
Max operating windspeed	12.5m/s

LICENCE REQUIREMENTS

Vehicle driving licence type	HGV
Operator Trained Level IPAF	1b
Self Drive option	No

Operating Noise level	<85Db
Operating temp range	-25° to +40°C
Manufacturer	Ruthmann
Alternative machines	T38B



WORKING ENVELOPE

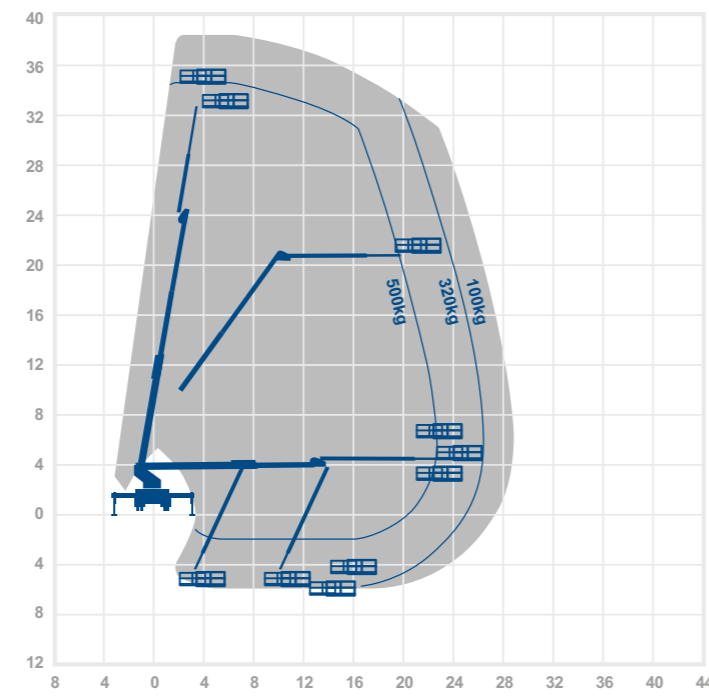

* (On standard spreader pads) these typical ground forces are based on the units standard size pad, the forces can be further reduced by scaling up the pad size.

† Depending on load, angle of rotation and outrigger configuration.

0345 745 0000
nationwideplatforms.co.uk

T38B

Specification



Working Height (m)
38.0

Max Horizontal Outreach (m)
25.3

WORKING CAPABILITIES	
Working Height	38.0m
Max Horizontal Outreach	25.3m (120kg)
Max Horizontal Outreach (full SWL)	21.0m
Max Reach below 0m (negative envelope)	6.5m
Platform/cage size	2.3m x 1.05m
Extending cage	3.7m
Operational Full Width	6.2m
Minimum Operational width (straight down jacking)	2.8m

MACHINE DIMENSIONS

Overall travel Length	10.0m
Overall travel Height	3.7m
Overall travel Width	2.5m
Max SWL†	600kg
Gross vehicle weight class	18000kg

MACHINE ATTRIBUTES

4 wheel drive	No
Number of axles	2
Rear steer	No
Articulated boom / Stick boom	Stick boom
Platform height	36.0m
One sided jacking	4.2m
Jacking type	H Frame variable
Point load Front / Rear	150kN/150kN
Typical ground pressure*	2.7kgf/cm²
Left or Right hand drive	Left

ADDITIONAL FUNCTIONALITY

Rotating cage	Yes
Earthing Cable	Yes
Jib Boom	Yes
Power to platform (cable and outlets only)	110v cable
Circular Camera cage option	Yes
Lighting rig option	Yes
Camera pod option	Yes
Camera cable	No
Max operating windspeed	12.5m/s

LICENCE REQUIREMENTS

Vehicle driving licence type	HGV
Operator Trained Level IPAF	1b
Self Drive option	No

Operating Noise level	<85Db
Operating temp range	-25° to +40°C
Manufacturer	Bronto
Alternative machines	T37R



WORKING ENVELOPE

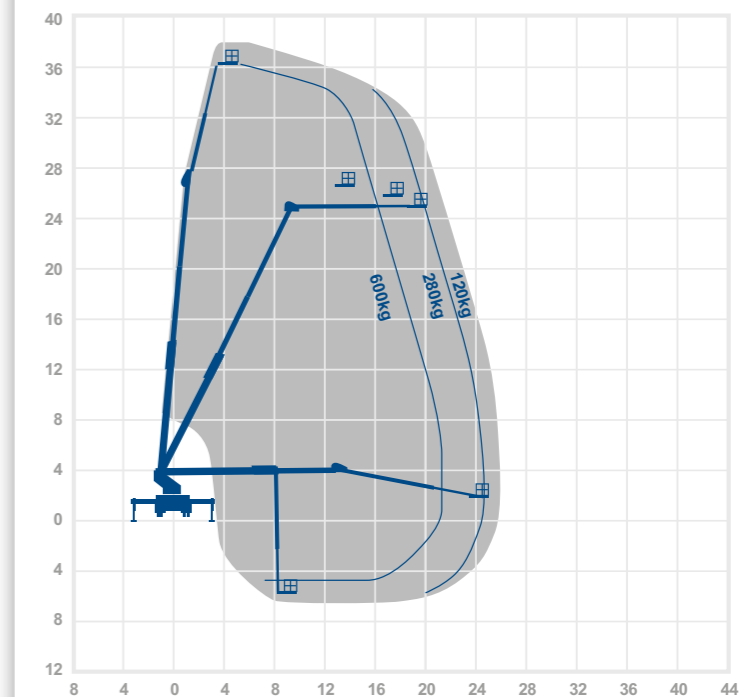

* (On standard spreader pads) these typical ground forces are based on the units standard size pad, the forces can be further reduced by scaling up the pad size.

† Depending on load, angle of rotation and outrigger configuration.

0345 745 0000
nationwideplatforms.co.uk

Operator driven big kit

Typical applications

- Construction
- Wind
- Infrastructure & Power Distribution
- TV & Film Production
- Large Building Maintenance
- Telecoms

Range attributes

- Working heights from 13 to 90 metres
- All vehicles available with our highly experienced IPAF & OEM trained operators
- Most cost-effective method of access for short term hires
- Large fleet of 4-wheel drive machines, ideal for off road applications
- Narrow jacking and zero tail swing models available
- Safe working loads up to 700kg, ideal for fitting of our specialist sector attachments for Telecoms & Media clients

BIG KIT
operator driven large capability machines

**BIG
KIT**

Case study

Project

Rhyl Skytower

Product

Bronto T90B

Application / Sector

Telecommunications

Project Details

Nationwide Platforms recently supplied our flagship T90B truck mounted platform to enable our customer to perform essential inspections and maintenance to Telecoms antennas fixed to the top of the 76 metre Rhyl Sky Tower in Wales.

Part of an annual maintenance programme, the 90 metre height and outreach of 31 metres of the T90B allowed the service engineer and their equipment access to inspect the antennas quickly and efficiently.

An experienced Nationwide Platforms operator was utilised to ensure the engineers were free to carry out the necessary repair work.



T44B

Specification

BIG KIT

Working Height (m)
44.0

Max Horizontal Outreach (m)
24.0

WORKING CAPABILITIES	
Working Height	44.0m
Max Horizontal Outreach	24.0m (120kg)
Max Horizontal Outreach (full SWL)	21.0m
Max Reach below 0m (negative envelope)	5.0m
Platform/cage size	2.4m (3.7m) x 1.0m
Extending cage	3.7m
Operational Full Width	6.2m
Minimum Operational width (straight down jacking)	2.8m

MACHINE DIMENSIONS

Overall travel Length	10.0m
Overall travel Height	3.8m
Overall travel Width	2.5m
Max SWL†	600kg
Gross vehicle weight class	18000kg

MACHINE ATTRIBUTES

4 wheel drive	No
Number of axles	2
Rear steer	No
Articulated boom / Stick boom	Stick boom
Platform height	42.0m
One sided jacking	4.5m
Jacking type	H frame variable
Point load Front / Rear	150kN/150kN
Typical ground pressure*	3.1kgf/cm ²
Left or Right hand drive	Left

ADDITIONAL FUNCTIONALITY

Rotating cage	Yes
Earthing Cable	No
Jib Boom	Yes
Power to platform (cable and outlets only)	110v cable
Circular Camera cage option	Yes
Lighting rig option	No
Camera pod option	No
Camera cable	No
Max operating windspeed	12.5m/s

LICENCE REQUIREMENTS

Vehicle driving licence type	HGV
Operator Trained Level IPAF	1b
Self Drive option	No

Tyre size front	315/80R22.5
Tyre size rear	315/80R22.5
Axle weight 1	8500kg
Axle weight 2	11500kg
Operating Noise level	<85Db
Operating temp range	-25° to +40°C
Manufacturer	Bronto
Alternative machines	T46B / T48P / T50JB



WORKING ENVELOPE

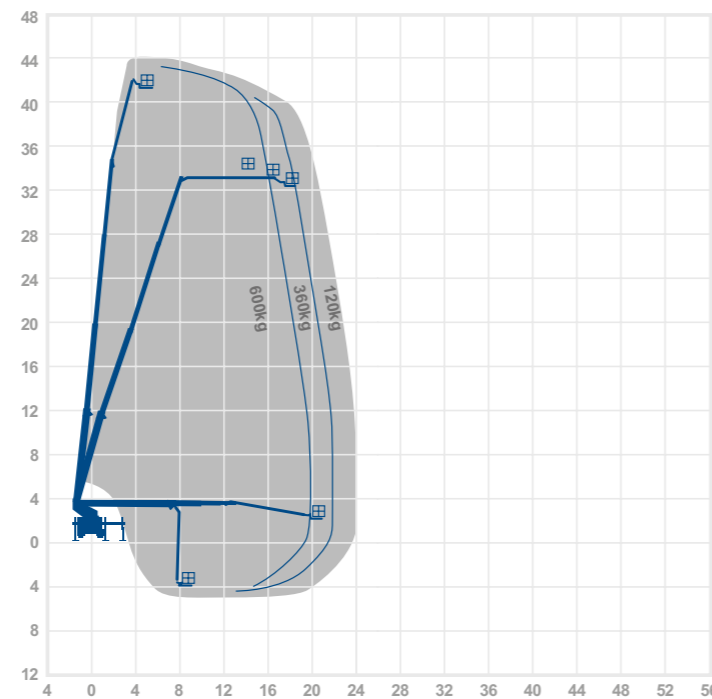

* (On standard spreader pads) these typical ground forces are based on the units standard size pad, the forces can be further reduced by scaling up the pad size.
† Depending on load, angle of rotation and outrigger configuration.

0345 745 0000
nationwideplatforms.co.uk

T46B

Specification

BIG KIT

Working Height (m)
45.0

Max Horizontal Outreach (m)
24.5

WORKING CAPABILITIES	
Working Height	45.0m
Max Horizontal Outreach	24.5m (120kg)
Max Horizontal Outreach (full SWL)	20.0m
Max Reach below 0m (negative envelope)	6.5m
Platform/cage size	2.47m x 1.05m
Extending cage	No
Operational Full Width	6.2m
Minimum Operational width (straight down jacking)	2.8m

MACHINE DIMENSIONS

Overall travel Length	10.5m
Overall travel Height	3.7m
Overall travel Width	2.5m
Max SWL†	600kg
Gross vehicle weight class	18000kg

MACHINE ATTRIBUTES

4 wheel drive	No
Number of axles	2
Rear steer	No
Articulated boom / Stick boom	Stick boom
Platform height	45.0m
One sided jacking	4.5m
Jacking type	H Frame variable
Point load Front / Rear	150kN/150kN
Typical ground pressure*	3.1kgf/cm ²
Left or Right hand drive	Right

ADDITIONAL FUNCTIONALITY

Rotating cage	Yes
Earthing Cable	No
Jib Boom	Yes
Power to platform (cable and outlets only)	110v cable
Circular Camera cage option	Yes
Lighting rig option	No
Camera pod option	Yes
Camera cable	No
Max operating windspeed	12.5m/s

LICENCE REQUIREMENTS

Vehicle driving licence type	HGV
Operator Trained Level IPAF	1b
Self Drive option	No

Operating Noise level	<85Db
Operating temp range	-25° to +40°C
Manufacturer	Bronto
Alternative machines	T48P / T50JB



WORKING ENVELOPE

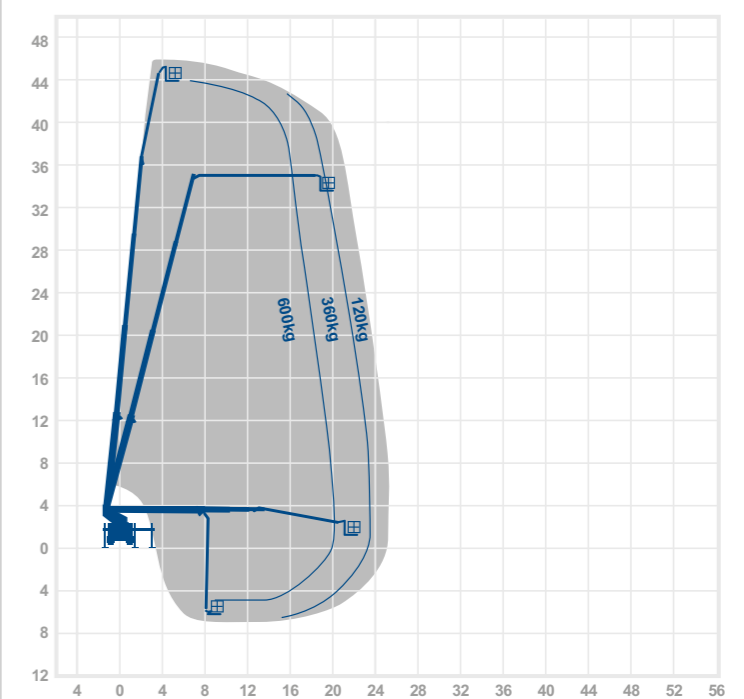

* (On standard spreader pads) these typical ground forces are based on the units standard size pad, the forces can be further reduced by scaling up the pad size.
† Depending on load, angle of rotation and outrigger configuration.

0345 745 0000
nationwideplatforms.co.uk

T48P

Specification

BIG KIT

Working Height (m) **48.0**

Max Horizontal Outreach (m) **28.0**

WORKING CAPABILITIES	
Working Height	48.0m
Max Horizontal Outreach	28.0m (100kg)
Max Horizontal Outreach (full SWL)	22.0m
Max Reach below 0m (negative envelope)	13.5m
Platform/cage size	2.15m (3.88m) x 1.05m
Extending cage	3.88m
Operational Full Width	6.3m
Minimum Operational width (straight down jacking)	2.55m

MACHINE DIMENSIONS

Overall travel Length	10.4m
Overall travel Height	4.0m
Overall travel Width	2.55m
Max SWL†	600kg
Gross vehicle weight class	17600kg

MACHINE ATTRIBUTES

4 wheel drive	No
Number of axles	2
Rear steer	No
Articulated boom / Stick boom	Stick boom
Platform height	46.0m
One sided jacking	6.3m
Jacking type	H Frame variable
Point load Front / Rear	160kN/160kN
Typical ground pressure*	3.4kgf/cm ²
Left or Right hand drive	Left

ADDITIONAL FUNCTIONALITY

Rotating cage	Yes
Earthing Cable	No
Jib Boom	Yes
Power to platform (cable and outlets only)	110v cable
Circular Camera cage option	No
Lighting rig option	Yes
Camera pod option	Yes
Camera cable	No
Max operating windspeed	12.5m/s

LICENCE REQUIREMENTS

Vehicle driving licence type	HGV
Operator Trained Level IPAF	1b
Self Drive option	No
Operating Noise level	<85Db
Operating temp range	-25° to +40°C
Manufacturer	Palfinger
Alternative machines	T50JB / T56B

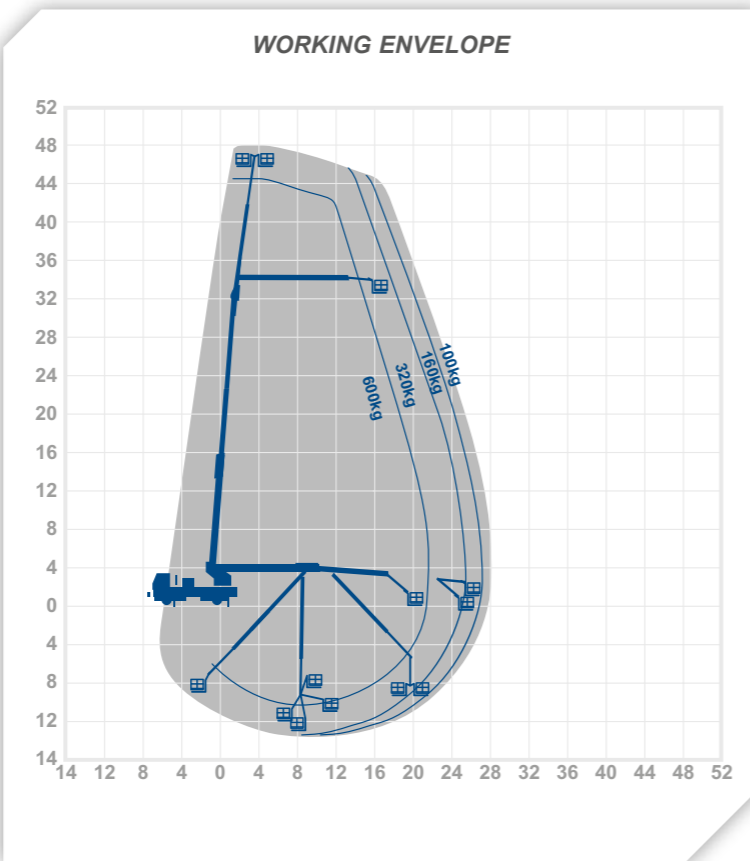

* (On standard spreader pads) these typical ground forces are based on the units standard size pad, the forces can be further reduced by scaling up the pad size.

† Depending on load, angle of rotation and outrigger configuration.

0345 745 0000
nationwideplatforms.co.uk

T50JB

Specification

BIG KIT

Working Height (m) **48.0**

Max Horizontal Outreach (m) **35.0**

WORKING CAPABILITIES	
Working Height	48.0m
Max Horizontal Outreach	35.0m (120kg)
Max Horizontal Outreach (full SWL)	37.3m (200kg)
Max Reach below 0m (negative envelope)	11.0m
Platform/cage size	2.2m (3.7m) x 0.9m
Extending cage	3.7m
Operational Full Width	8.0m
Minimum Operational width (straight down jacking)	2.8m

MACHINE DIMENSIONS

Overall travel Length	12.0m
Overall travel Height	4.0m
Overall travel Width	2.5m
Max SWL†	600kg
Gross vehicle weight class	26000kg

MACHINE ATTRIBUTES

4 wheel drive	No
Number of axles	3
Rear steer	Yes
Articulated boom / Stick boom	Stick boom
Platform height	48.0m
One sided jacking	5.4m
Jacking type	H Frame variable
Point load Front / Rear	190kN/190kN
Typical ground pressure*	2.7kgf/cm ²
Left or Right hand drive	Left

ADDITIONAL FUNCTIONALITY

Rotating cage	Yes
Earthing Cable	Yes
Jib Boom	Yes
Power to platform (cable and outlets only)	110v cable
Circular Camera cage option	Yes
Lighting rig option	Yes
Camera pod option	Yes
Camera cable	No
Max operating windspeed	12.5m/s

LICENCE REQUIREMENTS

Vehicle driving licence type	HGV
Operator Trained Level IPAF	1b
Self Drive option	No

Tyre size front	385/65R22.5
Tyre size rear	315/80R22.5
Axle weight 1	17220kg
Axle weight 2	211420kg
Axle weight 3	37400kg
Operating Noise level	<85Db
Operating temp range	-25° to +40°C
Manufacturer	T56B

Cage winch option available

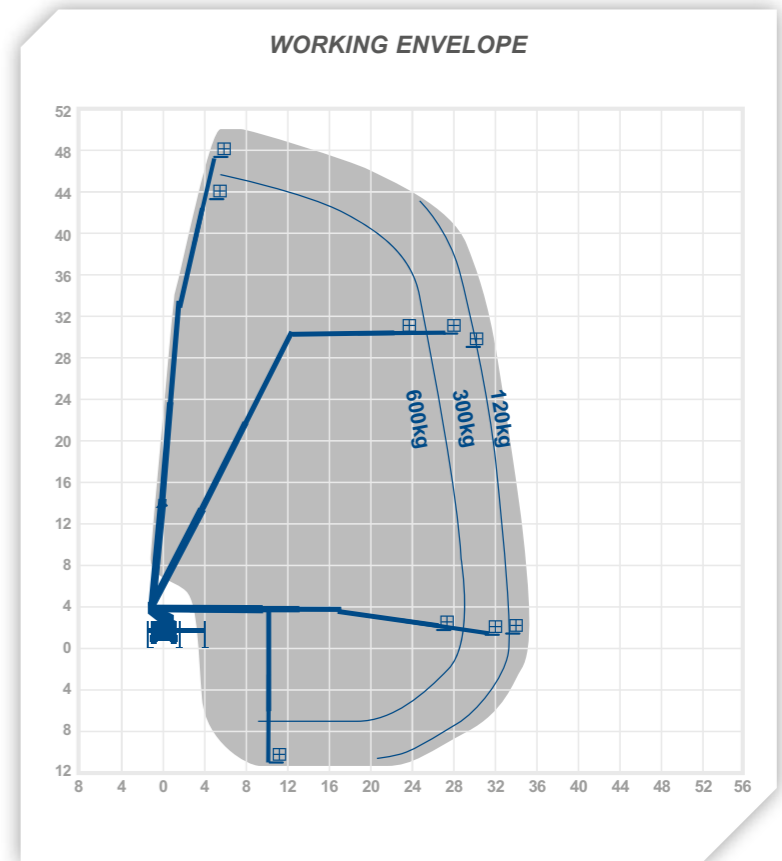

* (On standard spreader pads) these typical ground forces are based on the units standard size pad, the forces can be further reduced by scaling up the pad size.

† Depending on load, angle of rotation and outrigger configuration.

0345 745 0000
nationwideplatforms.co.uk

T56B-XR

Specification

BIG KIT

Working Height (m) 
56.0

Max Horizontal Outreach (m) 
37.3

WORKING CAPABILITIES	
Working Height	56.0m
Max Horizontal Outreach	37.3m (200kg)
Max Horizontal Outreach (full SWL)	32.0m
Max Reach below 0m (negative envelope)	9.0m
Platform/cage size	2.4m x 1.0m
Extending cage	3.7m
Operational Full Width	9.0m
Minimum Operational width (straight down jacking)	3.0m

MACHINE DIMENSIONS	
Overall travel Length	11.9m
Overall travel Height	3.7m
Overall travel Width	2.5m
Max SWL†	600kg
Gross vehicle weight class	26000kg

MACHINE ATTRIBUTES	
4 wheel drive	No
Number of axles	3
Rear steer	Yes
Articulated boom / Stick boom	stick boom
Platform height	54.0m
One sided jacking	6.0m
Jacking type	H Frame variable
Point load Front / Rear	180kN/180kN
Typical ground pressure*	3.2kgf/cm ²
Left or Right hand drive	Left

ADDITIONAL FUNCTIONALITY	
Rotating cage	Yes
Earthing Cable	Yes
Jib Boom	Yes
Power to platform (cable and outlets only)	110v cable
Circular Camera cage option	Yes
Lighting rig option	Yes
Camera pod option	Yes
Camera cable	No
Max operating windspeed	12.5m/s

LICENCE REQUIREMENTS	
Vehicle driving licence type	HGV
Operator Trained Level IPAF	1b
Self Drive option	No

Tyre size front	385/65R22.5
Tyre size rear	315/80R22.5
Axle weight 1	7220kg
Axle weight 2	11420kg
Axle weight 3	7400kg
Operating Noise level	<85Db
Operating temp range	-25° to +40°C
Manufacturer	T70B

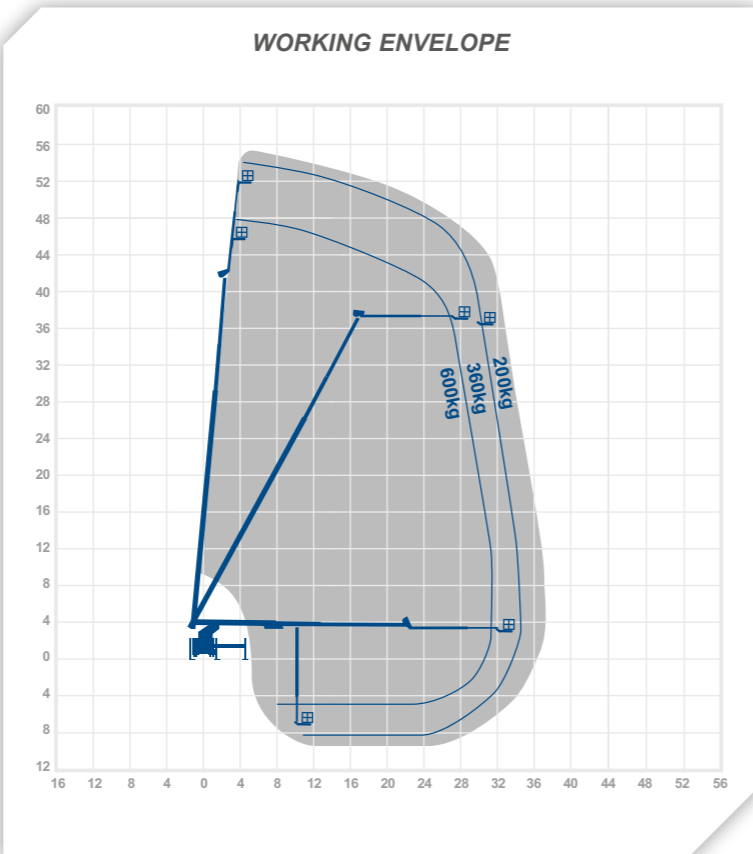

* (On standard spreader pads) these typical ground forces are based on the units standard size pad, the forces can be further reduced by scaling up the pad size.
† Depending on load, angle of rotation and outrigger configuration.

0345 745 0000
nationwideplatforms.co.uk

T70B

Specification

BIG KIT

Working Height (m) 
70.0

Max Horizontal Outreach (m) 
34.8

WORKING CAPABILITIES	
Working Height	70.0m
Max Horizontal Outreach	34.8m (120kg)
Max Horizontal Outreach (full SWL)	30.0m
Max Reach below 0m (negative envelope)	6.0m
Platform/cage size	2.4m (3.7m) x 1.0m
Extending cage	3.7m
Operational Full Width	8.0m
Minimum Operational width (straight down jacking)	3.2m

MACHINE DIMENSIONS	
Overall travel Length	12.5m
Overall travel Height	4.2m
Overall travel Width	2.5m
Max SWL	600kg
Gross vehicle weight class	36000kg

MACHINE ATTRIBUTES	
4 wheel drive	No
Number of axles	4
Rear steer	Yes
Articulated boom / Stick boom	Stick boom
Platform height	68.0m
One sided jacking	5.6m
Jacking type	H Frame variable
Point load Front / Rear	255kN/255kN
Typical ground pressure*	3.5kgf/cm ²
Left or Right hand drive	Left

ADDITIONAL FUNCTIONALITY	
Rotating cage	Yes
Earthing Cable	Yes
Jib Boom	Yes
Power to platform (cable and outlets only)	110v cable
Circular Camera cage option	Yes
Lighting rig option	Yes
Camera pod option	Yes
Camera cable	No
Max operating windspeed	12.5m/s

LICENCE REQUIREMENTS	
Vehicle driving licence type	HGV
Operator Trained Level IPAF	1b
Self Drive option	No

Tyre size front	385/55R22.5 9S Single
Tyre size rear	315/70R22.5
Axle weight 1	8940kg
Axle weight 2	8850kg
Axle weight 3	8850kg
Axle weight 4	9140kg
Operating Noise level	<85Db
Operating temp range	-25° to +40°C
Manufacturer	Bronto
Alternative machines	T90B



Cage winch option available

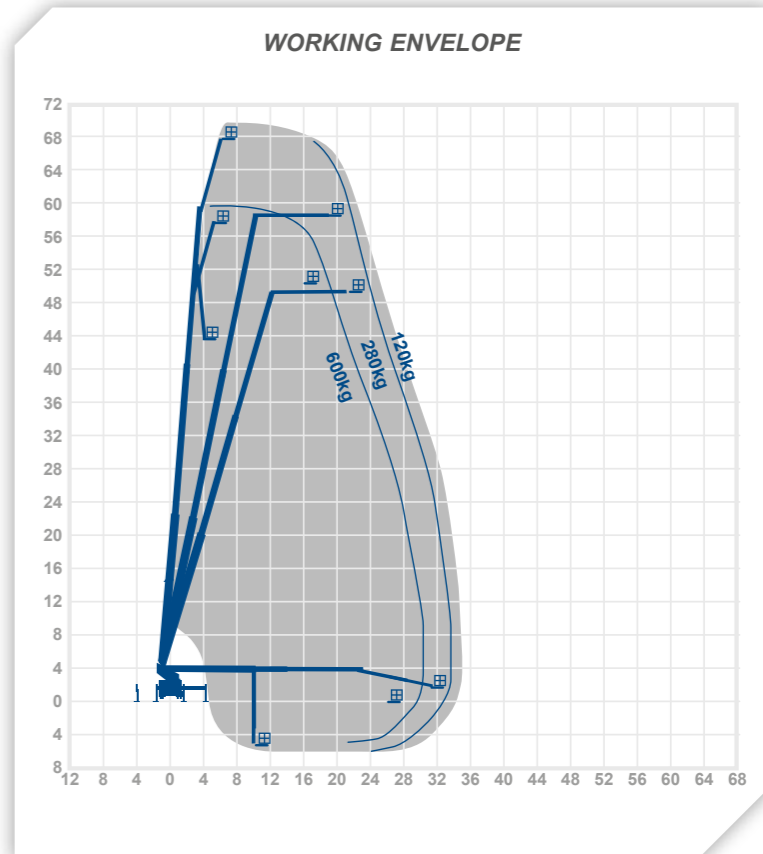

* (On standard spreader pads) these typical ground forces are based on the units standard size pad, the forces can be further reduced by scaling up the pad size.

0345 745 0000
nationwideplatforms.co.uk

BIG
KIT

T90B Specification

Working Height (m)
90.0

Max Horizontal Outreach (m)
31.0

WORKING CAPABILITIES

Working Height	90.0m
Max Horizontal Outreach	31.0m (400kg)
Max Horizontal Outreach (full SWL)	29.0m
Max Reach below 0m (negative envelope)	12.0m
Platform/cage size	2.4m (3.7m) x 1.0m
Extending cage	3.7m
Operational Full Width	7.0m
Minimum Operational width (straight down jacking)	N/A

MACHINE DIMENSIONS

Overall travel Length	15.6m
Overall travel Height	4.0m
Overall travel Width	2.5m
Max SWL†	600kg
Gross vehicle weight class	48000kgs

MACHINE ATTRIBUTES

4 wheel drive	No
Number of axles	5
Rear steer	Yes
Articulated boom / Stick boom	High level articulated
Platform height	88.0m
One sided jacking	N/A
Jacking type	H Frame
Point load Front / Rear	270kN/270kN
Typical ground pressure*	3.6kgf/cm ²
Left or Right hand drive	Left

ADDITIONAL FUNCTIONALITY

Rotating cage	Yes
Earthing Cable	Yes
Jib Boom	Yes
Power to platform (cable and outlets only)	110v cable
Circular Camera cage option	Yes
Lighting rig option	Yes
Camera pod option	Yes
Camera cable	No
Max operating windspeed	12.5m/s

LICENCE REQUIREMENTS

Vehicle driving licence type	HGV
Operator Trained Level IPAF	1b
Self Drive option	No

Tyre size front	385/65R22.5
Tyre size rear	315/80R22.5
Operating Noise level	<85Db
Operating temp range	-25° to +40°C
Manufacturer	Bronto
Alternative machines	N/A



WORKING ENVELOPE

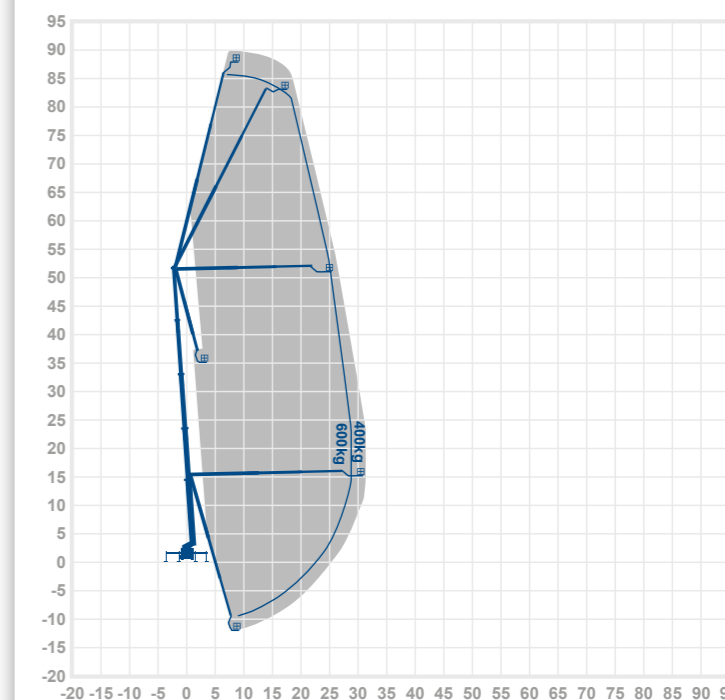

* (On standard spreader pads) these typical ground forces are based on the units standard size pad, the forces can be further reduced by scaling up the pad size.
† Depending on load, angle of rotation and outrigger configuration.

0345 745 0000
nationwideplatforms.co.uk

Case studies

Project

Filming of Peaky Blinders, Bolton

Product

T33R and T50JB

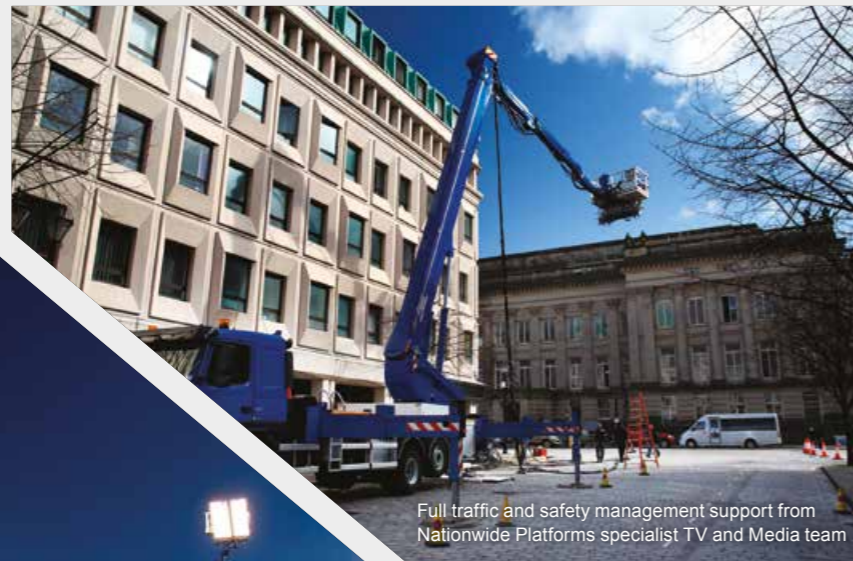

Full traffic and safety management support from Nationwide Platforms specialist TV and Media team

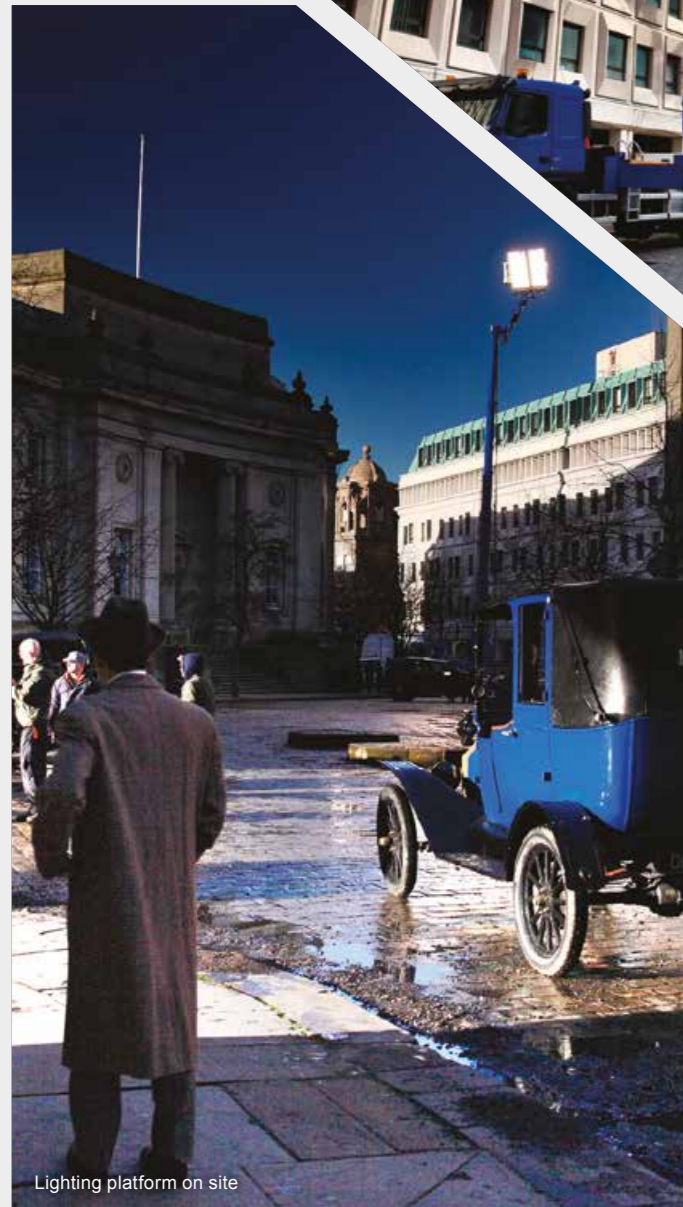

Lighting platform on site

Project Details

A T33R and T50JB truck mounted platform was used during the filming of the critically acclaimed television show, Peaky Blinders.

The T33R was used to facilitate smooth and steady filming up to heights of 33 metres, while the T50JB was fitted with the latest Wendy lighting frame attachment to provide artificial lighting on the set.

These truck mounts can also be fitted with camera pod, lighting frame attachments and the platform baskets replaced with 360 degree circular camera cages.

Timing on set is of the essence, and the planning and management was second to none

Project

Bristol Arena Development

Product

T48P



Versatile X-jib fitted for additional access capability

Application

Inspection application

Project Details

Part of a £91 million project to build a new 12,000-capacity entertainment arena in Bristol, Nationwide Platforms provided a 48 metre T48P truck mounted platform to clear vegetation from a retaining wall in order to structurally examine it.

Positioned 10 metres above the River Avon, the T48P versatile X-jib – which offers 240 degrees of articulation as well as up to eight metres negative reach – proved ideal for the task. With 2x200 degrees of platform rotation, the operator was able to rotate the basket 180 degrees flush to the wall, to offer the tree surgeon unrestricted access to the wall. The T48Ps extended platform basket also provided a greater work area, limiting the amount of times the platform needed to be repositioned.

As well as being well suited to work on dock quays and bridges, the T48Ps are also fitted Chalwyn valves which comply with refinery and petro-chemical sites. They also feature chassis-to-earth bonding kits allowing them to carry out industrial and high voltage electrical work.



Extended platform for greater work capacity

“

The specialist knowledge and support was invaluable

”

Project
Carno Wind Farm



The fleet scale and availability made Nationwide Platforms the obvious choice



Product
T38B



Turbine inspection



Experienced operator supports planned maintenance

Project Details

Nationwide Platforms recently supplied two T38B truck mounted platforms to assist with the inspection and maintenance of 56 three-blade wind turbines in Wales.

Part of an annual maintenance programme, the T38Bs allowed service engineers and their equipment access to inspect the wind turbine's blades, hub and nacelle, ensuring they continue to operate at optimum capacity. An experienced Nationwide Platforms operator was utilised to ensure the service engineer was free to carry out the necessary maintenance work.

With work dependent on suitable weather conditions, Nationwide Platforms relied on its fleet of truck mounted platforms – the largest in the UK- to ensure the availability of equipment on an ad hoc basis.





Training courses

IPAF Operator Courses

<p>1a Static Vertical Personnel Platform</p>	<p>1b Static Boom</p>
<p>3a Mobile Vertical</p>	<p>3b Mobile Boom</p>
<p>Push Around Vertical (PAV)</p>	<p>Competent Assessed Persons</p>
	<p>Advanced Operator Training</p>

Nationwide Platforms is the largest training provider of IPAF operator courses worldwide

With more IPAF instructors, training centres and experience in delivering courses than anyone else, you can rely on us to get you trained and ready to work safely on your next project.



We also offer a complete range of courses accredited and approved by:



Learn more about our complete range of training courses by viewing or downloading our full training guide.

Training Guide

Nationwide Platforms
A LOXAM Company

0845 745 0000
nationwideplatforms.co.uk

Training scale

Virtual Reality Training Simulator



The Virtual Reality simulator realistically mimics the sensation of boom and scissor lift operations. Training courses cover four principle areas:

- Introduction to Powered Access
- Operator Annual Assessment and Update
- Site Induction and Workforce Skills Assessment
- Risk Assessment Workshop (see over for details)

23 TRAINERS	400 COMBINED TRAINING YEARS EXPERIENCE
4820 COURSES PROVIDED IN 2019	22000 DELIGATES TRAINED
38 TRAINING CENTRES	2011-19 IPAF'S LARGEST TRAINING PROVIDER
33200 HOURS TRAINED	



Learn more about our complete range of training courses by viewing or downloading our full training guide.

IPAF Rental+

Nationwide Platforms has been awarded with Gold IPAF Rental+



THE HIGHEST STANDARD IN POWERED ACCESS EQUIPMENT HIRE

IPAF Rental+ provides assurance to customers at every stage of the MEWP hire/rental process.

Known in the industry as the independent quality mark for powered access hire companies, IPAF Rental+ is awarded to those who meet the most stringent standards of training, advice, equipment and customer satisfaction set by a committee of the most experienced players in the powered access rental business.

The Gold standard means Nationwide Platforms has displayed exemplary standards recognised by IPAF as a company who provides significant investment to go above and beyond the minimum standard.



Engineering excellence

Ensuring the safety of our customers whilst using our equipment is of paramount importance to us. That's why we put high quality engineering at the heart of our operations and make every effort to ensure our equipment is in prime condition, offers ultimate reliability and is above all, safe.

With the largest team of powered access engineers in the UK, we invest in and develop their expertise in order to provide unparalleled service, ensuring downtime is kept to an absolute minimum.



TechX is our commitment to achieving the very best in all of our operations and engineering activities. This initiative is dedicated to achieving technical excellence and world leading standards across every one of our workshops, offices and depots.

TechX, which is our dedication to achieving excellence not only in operations and engineering, but in everything we do. This newly enhanced programme will help us to drive consistent improvements across the organisation, ensuring that our clients benefit from the same high standards of reliability and quality wherever and whenever we're required to serve them.



Equipment sales

The UK's widest selection of new and used access platforms is available to buy now from Nationwide Platforms.

Whether you're seeking a unit from our leading fleet or looking for a brand new model direct from the manufacturer, we have the resources, expertise and know-how to find your perfect solution. We are also refurbishing units out of the fleet.



Scan the QR code or visit our website to learn more about our latest models on sale and find out more about purchasing access equipment or call: 0808 100 3604

Service & Hire Options

Whatever you're looking to achieve, we're proud to offer you a range of flexible hire & maintenance options.

In addition to our daily, weekly and monthly hire options, we can also offer long term agreements ideal for ongoing maintenance tasks and large projects.

Suitable for:

- Warehouse and logistics applications
- Long term maintenance and refurbishment projects
- Day to day facilities management tasks in retail, office, commercial and arena settings.

Technical & Maintenance Services

In addition to providing adaptable maintenance packages for short and long term hires, we can also offer you technical support in managing your own fleet requirements.

For professional advice & guidance in selecting the most suitable solution for your needs contact us today

0345 745 0000
nationwideplatforms.co.uk

Innovation

A simple and effective fleet management system



Nationwide Platforms innovative approach to working at height safety makes our use of powered access more efficient and effective



SkySentry™

SkySentry™ is a simple and effective fleet management system designed to help you reduce costs, drive efficiency and improve safety.

SkySentry™ is a full service system designed to improve the management of your powered access fleet across multiple sites and safeguard against unauthorised use.

The system offers unrivalled access and visibility of not only who is operating a machine at any one time, but also if they are correctly trained and authorised to do so.

Unique pin codes and/or smartID cards ensure only authorised and trained users operate the machines.

- The device automatically secures machine when not in use
- Prevents or allows sharing of machines depending on site requirements
- Provides management data which:
 - Confirms operator use and history of use on MEWPs
 - Monitors machine activity via pre-programmed parameters
 - Shows clearer utilisation of on-site MEWPs

Scan the QR code or visit our website to learn more.



An innovation in specialist attachments for the telecoms industry

SkyTel™

Nationwide Platforms' lightweight antenna handling device offers a solution to the challenges of lifting/lowering antennas

- Capable of up to 150kg (relative to MEWP safe working load capacity)
- Reduces manual handling and the need for alternative methods of lifting/lowering antennas - resulting in commercial and site space benefits
- Available across a range of truck mounted platforms with working heights from 22 to 90 metres
- No tools required, can be installed/removed on-site in just a few minutes
- CE-certified, OEM approved, tested and documented

For a professional approach, effective management, dedicated sector specialism, and high industry standards, you can rest assured that your telecoms projects are in safe hands with Nationwide Platforms

To discuss your specific project requirements in more detail, please contact **0808 100 3591** or telecoms@nationwideplatforms.co.uk

Scan the QR code or visit our website to learn more.





Advice and support

From your initial enquiry, Nationwide Platforms will manage a range of services, tailor-made to your needs, which include:

- **Site surveys** – followed up with a comprehensive report which as well as recommending the appropriate MEWPs for the job, also includes advice on traffic/ pedestrian management and trackway as well as any special site considerations.
- **Traffic / pedestrian management** – ensuring the appropriate level of work area and drop zone protection.
- **Trackway** – arrangement of installation and recovery.
- **Permits and notices** – liaising with local authorities to ensure compliance.
- **Electronic Transfer of Notices (EToNs)** – application submission.
- **Notices of works** – informing residents and businesses through a variety of avenues.
- **RAMS** – production of risk assessments and method statements, as well as berthing plans (where required).
- **Supply of the largest and most varied selection of MEWP's** which can be provided with or without an operator.



Regulations

Knowing your requirements

If you're working at height, it's important to understand the legislation and regulations which apply to you.

The Work at Height Regulations (2005) apply to all working at height where there is a risk of a fall liable to cause personal injury. These regulations are a key starting point for anyone responsible for individuals completing, supervising or planning work at height.

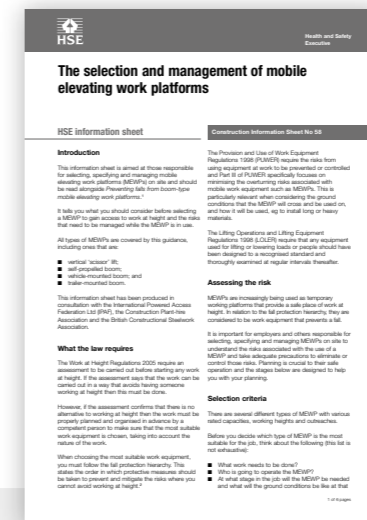

Best practice guides and legislation advice briefings

To help you work efficiently and safely at height Nationwide Platforms has a range of in depth guidance notes to aid understanding and implementation of best practice in the work place. These useful and informative guides are available online for you to download.

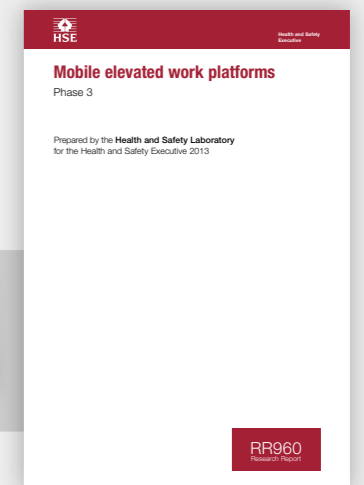

Scan the QR code or visit our website to learn more.

Locations

Supporting you at every height

With a fleet of more than 15,000 platforms available to hire across the UK, you can be sure that your perfect solution is never too far away.

SCOTLAND & NORTH EAST

ABERDEEN
Cairn Robin Pipeyard
Portlethen
Aberdeen
AB12 4SB

DUNDEE
6 Faraday Street
Dryburgh Industrial Estate,
Dundee
DD2 3QQ

GLASGOW
Customer Service Centre
Tel. 0345 600 1490 Unit B East Point
13 Melford Road
Righead Ind Estate
Bellshill
Glasgow
ML4 3LR

GLASGOW CITY
45 Methil Street
Glasgow
G14 0AG

EDINBURGH
Unit 6D
Uphall Business Park
Loaning Hill, Broxburn
West Lothian
EH52 5NT

MIDLANDS & THE NORTH

BARNSELEY
Unit 3
The Recovery Centre
Wakefield Rd
Barnsley
S71 1NU

BIRMINGHAM
Customer Service Centre
Tel. 0345 600 1492
Willenhall Road
Darlaston Wednesbury
West Midlands
WS10 8JG

BLACKBURN
New Trees Garage
Myerscough Road
Mellor Brook, Blackburn
BB2 7LB

DURHAM
Customer Service Centre
Tel. 0345 600 1496
Damson Way
Dragon Ville Industrial Estate
Durham
DH1 2YN

LEEDS
Old Run Road
Unit 1, Blackburn Works,
Hunslet
Leeds
LS10 2AA

LEICESTER
Unit 10-11
Arkwright Hill Farm
Lutterworth Road (A426)
Nr Cosby,
LE9 1RH

LIVERPOOL
Knowsley Industrial Estate,
Yardley Road
Kirkby, Liverpool
L33 7SS

NORTH WALES
Castle Close
Hawarden Industrial Park,
Hawarden,
Deeside
CH5 3QZ

NOTTINGHAM
Unit 21
Hazelford Way
Newstead
NG15 0DQ

SALFORD
2-4 Worrall Street
Salford, Manchester
M5 4TH

SCUNTHORPE
7 Atkinson Way Foxhill
Industrial Estate,
Scunthorpe, DN15 8QJ

STOCKTON ON TEES
1 Hurricane Court
Stockton-on-Tees
TS18 3TL

TEBAY
Unit 1, The Sidings
Tebay, Penrith
CA10 3XR

TELFORD
8 Halesfield Road
Madeley, Telford
TF7 4PL

WARRINGTON
Customer Service Centre
Tel. 0345 600 1491
Unit D, Appleton Industrial Park
Barleycastle Lane
Appleton Thorn
Warrington
WA4 4QT

WELLINGBOROUGH
Sidegate Lane
Wellingborough
Northants
NN8 1RN

SOUTH WEST & SOUTH WALES

AVONMOUTH
Victoria Road
Avonmouth
Bristol
BS11 9DB

DIDCOT
Hawksworth
Industrial Estate
Didcot, Oxfordshire
OX11 7HR

BRISTOL
Customer Service Centre
Tel. 0345 600 1494
Cumberland House
Ashton Gate
Marsh Road,
Bristol
BS3 2NA

CARDIFF
Castle Works
East Moors Road
Cardiff
CF24 5NN

LISKEARD
Customer Service Centre
Tel. 0345 600 1495
Moorswater Industrial Estate,
Liskeard
Cornwall
PL14 4LB

SWANSEA
Unit 8 RVB Park
Carnffrwd Way
Enterprise Park
Swansea
SA6 8QD

SOUTHAMPTON
Claylands Road
Industrial Estate
Bishops Waltham
SO32 1BH

TAUNTON
Venture Way
Priorswood Industrial Estate,
Taunton
Somerset
TA2 8DE

SOUTH EAST

BRENTWOOD
Childditch
Industrial Park
Childditch Hall Drive,
Brentwood
CM13 3HD

KENT
Plot 1, Thameside
Terminal, Cliffe
Nr Rochester
Kent
ME3 7SU

LONDON EAST
Customer Service Centre
Tel. 0345 600 1493
6 Oliver Road
West Thurrock
Essex
RM20 3ED

LONDON EAST
Plot 4, Riverside Ind Estate,
Oliver Close
West Thurrock
RM20 3EE

LONDON WEST
Wallingford Road
Uxbridge
UB8 2FR

LONDON WEST
West London Industrial Park
Iver Lane, Cowley,
Uxbridge
UB8 2JG

LUTON
Customer Service Centre
Tel. 01582 578074
Unit 12 Dencora Way
Sundon Park Ind Estate,
Luton,
LU3 3HP

NORWICH
Rookery Farm
Silver Street, Besthorpe
Norwich
NR17 2LD

PETERBOROUGH
Skylift House
Newark Road,
Peterborough
PE1 5YD

With a fleet of over 600 specialist vehicles operating from our strategically located Specialist Access depots we offer a truly nationwide service. Wherever your next project takes you, our equipment, expertise and innovations can support you when working at height.

With the back-up of Nationwide Platforms network of 38 depots across the country, specialist support is never more than a phone call away.

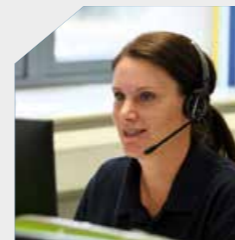

Core Specialist Vehicle Depots
Edinburgh, Warrington, Birmingham,
Luton, Bristol & Avonmouth

Product selection website

We aim to make doing business with Nationwide Platforms as easy as possible, with a straightforward and logical approach to help you work safely at height.



Product selection guide

Within this guide you should find access to all you need to identify which type of powered access you need, how to specify a particular machine, along with details and instructions of placing an order.

Our comprehensive Product Selection guide includes all aspects of the Nationwide Platforms powered access range including low level, scissor lifts, mast and articulated boom lifts, tracked boom lifts as well as our exclusive safety innovations and material handling attachments.

Request your copy by calling today!



0345 745 0000
nationwideplatforms.co.uk

PLEASE NOTE:

All technical information referred to in this document is intended for guidance purposes only and does not act as a replacement for the full manufacturer specification or equipment user guides.

All information provided is subject to alteration and amendment without prior notice. Please contact Nationwide Platforms for confirmation of machine performance and specification when placing your order.

National Coverage
Local Service
Global Reach



0345 745 0000
nationwideplatforms.co.uk

Nationwide Platforms
Midland Court
Lutterworth
Leicestershire
LE17 4PN

