



Powered Access Selection Guide

Working in partnership with

 Travis Perkins
Tool Hire
Tools, plant & equipment

 **Nationwide
Platforms**
A **LOXAM** Company



NEXT PAGE

Welcome to our powered access selection guide. Inside you'll find all the information you need to begin working safely and effectively at height.

To get you started we've included comprehensive guidance on our leading product range, as well as advice on the accessories, innovations and training that'll help you succeed on your next task or project.

Remember, if you want to get in touch with us at any point whilst you're browsing, you can give us a call with any enquiries, feedback or hire requests.

Back to start of section (scissors)

4626	scissors	6826D	scissors
Working Height 9.9m Closed Length 2.31m Closed Height 2.15m Stowed Height (guardrail lowered) 1.79m Closed Width 1.17m Platform Size 2.11m x 1.07m Platform Length (stack extended) 3.05m Max GVW 456kg Weight 2150kg	Alternative machines C1026 Manufacturer Skyjack	Working Height 9.92m Closed Length 3.12m Closed Height 2.37m Stowed Height (guardrail lowered) 1.61m Closed Width 1.72m Platform Size 2.44m x 1.42m Platform Length (stack extended) 3.96m Max GVW 567kg Weight 3309kg	Alternative machines C1026D Manufacturer Skyjack

0345 745 0000
nationwideplatforms.co.uk

Nationwide Platforms
A LOXAM Company

Previous page Back to home / contents page Next page

How to navigate through this document

Use these navigation buttons to jump straight to the product range where you'll find the products in ascending height order.



LOW LEVEL

SCISSORS

BOOMS

VANS

TRUCK MOUNTED

TRACKED BOOMS

TELE-HANDLERS

SAFETY, ATTACHMENTS, ACCESSORIES

0345 745 0000
nationwideplatforms.co.uk



If you can't find exactly what you're looking for or need more information, call our expertly trained staff.

Contents

Use this guide to find your perfect powered access solution.

Each section in this guide has been created to allow you to browse, select and order your ideal machine, attachments and accessories.

Information

Introduction	1
How to use this guide	4
Equipment Selection	5
Location	6
Safety	7
Stay connected	8
iPAF Rental+	8
Regulations	9
Training	10
Indemnity	11
Service & Hire Options	11
Equipment Sales	12

Product Specification

Low Level Access	13
Scissor Lifts	21
Boom Lifts	51
Van Mounted	82
Truck Mounted	85
Tracked Boom Lifts	102
Telehandlers	110
Safety Solutions, Attachments & Accessories	121

Useful Data

Weight Conversion	130
Distance Conversion	130



How to use this guide

This guide is designed to help you select and order the correct piece of equipment for your needs.

Each section is conveniently separated by product type and machines are arranged in order of ascending height.

The working envelope and height/reach indicator will provide a quick visual reference to assist your equipment selection.

If you cannot find exactly what you're looking for, need more information, or wish to order equipment, call our expertly trained staff on **0345 745 0000**

- 1 Product Code**
Unique reference number for product. (Please note this will not necessarily correspond with the original manufacturer's model number or product code)
- 2 Specification**
These details include product dimensions, Safe Working Load (SWL), platform area, rotation and machine weight.
- 3 Key**
These symbols indicate standard features and optional extras available to hire with the platform. See right for key table.

- 4 Working Envelope**
This shows the area of working space provided by the product.
- 5 Product Type**
Indicates classification of powered access unit, e.g. machine types: low level access, scissor lift, boom lift, truck or van mounted platform, specialist boom or telehandler.

- 6 Alternative Machines**
Indicates alternative or similar machines.
- 7 Working Height**
The blue column indicates the safe operating vertical height.

- 8 Horizontal Outreach**
The grey column indicates the safe operating outreach.

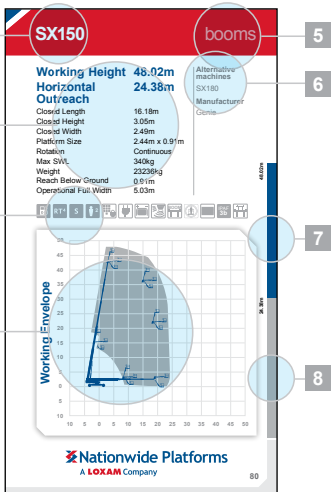

Height and outreach

Working height Horizontal outreach

Key

Standard features

Battery power	IPAF 1a IPAF licence type	Outrigger legs
Diesel power	IPAF 1b IPAF licence type	2 Maximum people in cage*
Lithium battery	IPAF 3a IPAF licence type	Push around vehicles
Hybrid power	IPAF 3b IPAF licence type	Operator powered
Dual fuel option	IPAF PAV IPAF licence type	Indoor use only
Gas power option	T Tracked	Self drive
Rough terrain (2 wheel drive)	M Mast boom	JIB rotation
Rough terrain (4 wheel drive)	A Articulating boom	IPAF driving licence type
Non-marking tyres	S Straight telescopic boom	

Optional extras

SkyShield	SkySiren®	SkyScreen™
SkySiren® PCS™	MHA Material Handling Attachments	Power to platform
SkySentry™	Generator	Camera pod
SkyRak®	Circular camera cage	Wendy lighting frame
SkyRakPlus®	SkyTel™	SkyRakMulti™
SkyRakBoom®		
SkyTel™		
SkyRakEdge™		

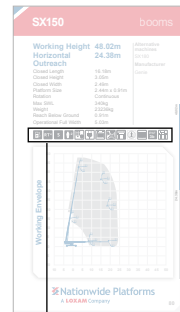

Equipment Selection

Considerations in selecting the right equipment for your task.

Before you get started, it's essential you make sure you have the right training to work safely and legally. Call us to learn more about our training services.

1

Height & Outreach

Do I need to reach a height straight up or do I need to reach up and then over?

For vertical access, scissor lifts may be best. When working over racking and shelving, mast booms are ideal. When working over obstacles, articulated booms provide a versatile solution.

2

Environment

Will I be working indoors or outdoors?

Use a zero emission electric machine indoors, and in general a diesel machine outdoors. For versatility, consider a dual fuel unit.

3

Terrain

What are the ground conditions I'll be working on?

If you're working indoors, consider non-marking tyres. On rough terrain select a four wheel drive option and select outriggers on sloping ground.

4

Access

Are there any access restrictions to entering the working environment?

Indoors, will machines pass through doorways and lift shafts? Does the site have plant weight restrictions?

5

Working height

How far up and how far out do I need to reach?

Always check the working envelope diagrams to ensure the outreach required can be achieved at the height(s) you need to carry out your task. Also consider that maximum working heights are assumed as 2m above the platform height (feet level).

6

Hire duration

How long do I need a machine for?

Self drive and other vehicle mounted platforms may suit short projects. We offer machine hires from one day to many years, as well as equipment for outright purchase.

0345 745 0000
nationwideplatforms.co.uk



 **Nationwide Platforms**
A **LOXAM** Company

Location

Supporting you at every height

With a fleet of more than 15,500 platforms available to hire across the UK, you can be sure that your perfect solution is never too far away.



0345 745 0000
nationwideplatforms.co.uk



Nationwide Platforms
A **LOXAM** Company

SCOTLAND & NORTH EAST

ABERDEEN

Cairn Robin Pipeyard
Portlethen
Aberdeen
AB12 4SB

DUNDEE

6 Faraday Street
Dryburgh Industrial Estate,
Dundee
DD2 3QQ

GLASGOW

Customer Service Centre

Tel. 0345 600 1490

Unit B East Point
13 Melford Road
Righead Ind Estate
Bellshill
Glasgow
ML4 3LR

GLASGOW CITY

45 Methil Street
Glasgow
G14 0AG

EDINBURGH

Unit 6D
Uphall Business Park
Loaning Hill,
Broxburn
West Lothian
EH52 5NT

MIDLANDS & THE NORTH

BARNSELY

Unit 3
The Recovery Centre
Wakefield Rd
Barnsley
S71 1NU

BIRMINGHAM

Customer Service Centre

Tel. 0345 600 1492

Willenhall Road
Darlaston
Wednesbury
West Midlands
WS10 8JG

BLACKBURN

New Trees Garage
Myerscough Road
Mellor Brook,
Blackburn
BB2 7LB

DURHAM

Customer Service Centre

Tel. 0345 600 1496

Damson Way
Dragon Ville
Industrial Estate
Durham
DH1 2YN

LEEDS

Tel. 0345 600 1491

Old Run Road
Unit 1, Blackburn
Works, Hunslet
Leeds
LS10 2AA

LEICESTER

Unit 10-11
Arkwright Hill Farm
Lutterworth Road
(A426) Nr Cosby,
LE9 1RH

LIVERPOOL

Knowsley Industrial Estate,
Yardley Road
Kirkby, Liverpool
L33 7SS

NORTH WALES

Castle Close
Hawarden Industrial Park,
Hawarden,
Deeside
CH5 3QZ

NOTTINGHAM

Unit 21
Hazelford Way
Newstead
NG15 0DQ

SCUNTHORPE

7 Atkinson Way
Foxhill Industrial Estate,
Scunthorpe,
DN15 8QJ

STOCKTON ON TEES

1 Hurricane Court
Stockton-on-Tees
TS18 3TL

WARRINGTON

Customer Service Centre
Tel. 0345 600 1491
 Unit D, Appleton Industrial Park
 Barleycastle Lane
 Appleton Thorn
 Warrington
 WA4 4QT

WELLINGBOROUGH

Sidegate Lane
 Wellingborough
 Northants
 NN8 1RN

SOUTH WEST & SOUTH WALES

AVONMOUTH

Victoria Road
 Avonmouth
 Bristol
 BS11 9DB

DIDCOT

Hawksworth
 Industrial Estate
 Didcot, Oxfordshire
 OX11 7HR

BRISTOL

Customer Service Centre
Tel. 0345 600 1494
 Cumberland House
 Ashton Gate
 Marsh Road,
 Bristol
 BS3 2NA

CARDIFF

Tel. 0345 600 1494
 Castle Works
 East Moors Road
 Cardiff
 CF24 5NN

LISKEARD

Customer Service Centre
Tel. 0345 600 1495
 Moorswater Industrial Estate, Liskeard
 Cornwall
 PL14 4LB

SWANSEA

Unit 8 RVB Park
 Carnffrwd Way
 Enterprise Park
 Swansea
 SA6 8QD

SOUTHAMPTON

Claylands Road
 Industrial Estate
 Bishops Waltham
 SO32 1BH

TAUNTON

Venture Way
 Priorswood Industrial Estate, Taunton
 Somerset
 TA2 8DE

SOUTH EAST

BRENTWOOD

Childerditch
 Childerditch Park
 Childerditch Hall Drive,
 Brentwood
 CM13 3HD

KENT

Plot 1, Thameside
 Terminal, Cliffe
 Nr Rochester
 Kent
 ME3 7SU

LONDON EAST

Customer Service Centre
Tel. 0345 600 1493
 6 Oliver Road
 West Thurrock
 Essex
 RM20 3ED

LONDON WEST

West London
 Industrial Park
 Iver Lane, Cowley,
 Uxbridge
 UB8 2JG

LUTON

Customer Service Centre
Tel. 01582 578074
 Unit 12 Decora Way
 Sundon Park Ind Estate,
 Luton,
 LU3 3HP

NORWICH

Rookery Farm
 Silver Street,
 Besthorpe
 Norwich
 NR17 2LD

Your safety, our priority.

At Nationwide Platforms, safety is always our number one priority.

That's why every single step we take to serve you has been designed with your welfare and wellbeing in mind.

We'd like to invite you to join our safety journey and see why you can always trust our products and services to provide the safeguard you need.



**YOUR SAFETY
 OUR PRIORITY**

0345 745 0000
nationwideplatforms.co.uk



Nationwide Platforms

A **LOXAM** Company

Regulations

Knowing your requirements

If you're working at height, it's important to understand the legislation and regulations which apply to you.

The Work at Height Regulations (2005) apply to all work at height where there is a risk of a fall liable to cause personal injury. These regulations are a key starting point for anyone responsible for individuals completing, supervising or planning work at height.

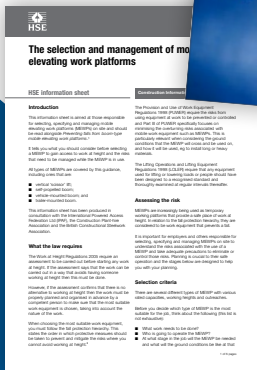
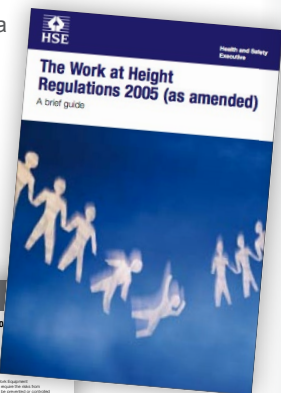

To help you work efficiently and safely at height Nationwide Platforms has a range of in depth guidance notes to aid understanding and implementation of best practice in the work place.

These useful and informative guides are available on request.



0345 745 0000
nationwideplatforms.co.uk



 **Nationwide Platforms**
A **LOXAM** Company



Training Courses

With more IPAF instructors, training centres and experience in delivering courses than anyone else, you can rely on us to get you trained and ready to work safely on your next project.

Our IPAF Operator courses are available to complete at training centres across the UK and can even be held on your own site.

IPAF Operator Courses

1a Static Vertical Personnel Platform



1b Static Boom



3a Mobile Vertical



3b Mobile Boom



Push Around Vertical (PAV)



Advanced Operator Training



Our complete range of training courses are ideal for anyone looking for advanced or specialist training.

Our additional range of training for powered access users includes:

IPAF MEWPs for Managers

The essential one day course for individuals managing, supervising or planning work at height



We also offer a complete range of courses accredited and approved by:



PowerGuard

All our machines and equipment is hired out under the Construction Plant Hire Association Model Conditions for hiring of plant (July 2011). These terms and conditions place the responsibility on the hirer for any loss or damage of the equipment hired.

With the cost of loss and damage potentially running into thousands of pounds, PowerGuard offers a peace of mind indemnity to our hire customers.

Two levels of PowerGuard are available:

Gold (damage only) and **Platinum** (damage and loss).*

Protect yourself against costs of machine damage or loss



handrail
£2,500

controller
£600

cage
£3,000

engine
£7,000

battery
£1,800

machine
£200,000

tyres
£1,000

For more information on the advantages of our PowerGuard scheme or to add PowerGuard to your account, contact us on **0345 745 0000**.

*Subject to terms & conditions.

Whatever you're looking to achieve, we're proud to offer you a range of flexible hire & maintenance options.

Long term hire

In addition to our daily, weekly and monthly hire options, we can also offer long term agreements ideal for ongoing maintenance tasks and large projects.

Suitable for:

- Warehouse and logistics applications
- Long term maintenance and refurbishment projects
- Day to day facilities management tasks in retail, office, commercial and arena settings

Technical & maintenance services

In addition to providing adaptable maintenance packages for short and long term hires, we can also offer you technical support in managing your own fleet requirements.

For professional advice & guidance in selecting the most suitable solution for your needs contact us today



Equipment Sales

The UK's widest selection of new and used access platforms is available to buy now from Nationwide Platforms.

Whether you're seeking a unit from our leading fleet or looking for a brand new model direct from the manufacturer, we have the resources, expertise and know-how to find your perfect solution. We are also refurbishing units out of the fleet.

What's more, we also offer a range of finance and servicing packages.

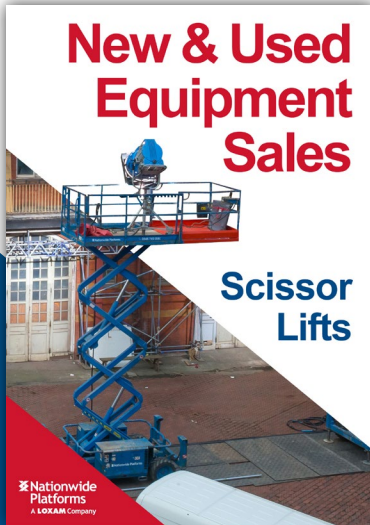

**New & Used
Equipment
Sales**

**Scissor
Lifts**

Nationwide
Platforms
A LOXAM Company



Booms

**For
Sale**



Trucks

**For
Sale**



For information please call
0808 100 3604
or visit our website...
nationwideplatforms.co.uk



Nationwide Platforms
A **LOXAM** Company

Low Level Access



- More than 1,000 units available to hire across the UK
- Working heights up to 9.5m
- Lightweight models from 180kg
- Non-marking tyres for use on finished floors

Machine type by product code

Pecolift	SJ12
NANO	GR15
NANO SP	SJ16
NANO SP+	GR20
LEONARDO HD	GP20
POWER TOWER	GP25
GR12	



0345 745 0000
nationwideplatforms.co.uk



Nationwide Platforms
A **LOXAM** Company



Working Height 3.5m

Closed Length	0.98m
Closed Height	1.55m
Closed Width	0.75m
Platform Size	0.72m x 0.60m
Max SWL	150kg
Weight	180kg

Alternative machines
NANO
Manufacturer
POWER TOWERS

Indoor use only

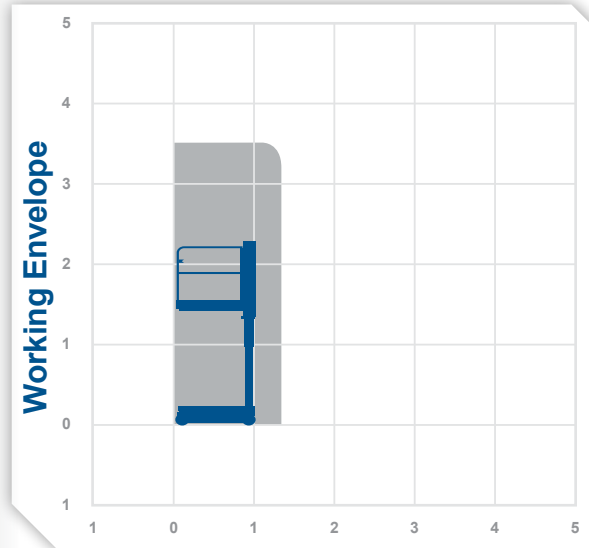

0345 745 0000
nationwideplatforms.co.uk



We're also pleased to offer wind rated Pecolift models designed for use outdoors. Contact us today to learn more.

Working Height 4.5m

Closed Length	1.195m
Closed Height	1.56m
Closed Width	0.75m
Platform Size	1.0m x 0.73m
Max SWL	200kg
Weight	285kg

Alternative machines

Nano SP

Manufacturer

POWER TOWERS

Indoor use only

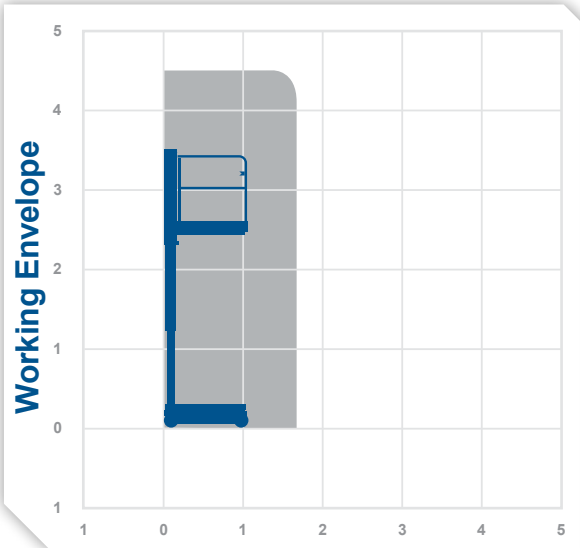

Working Height 4.5m

Closed Length	1.2m
Closed Height	1.59m
Closed Width	0.75m
Platform Size	1.0m x 0.73m
Platform Length – deck extended	1.5m
Max SWL	200kg
Weight	506kg

Alternative machines

NANO
NANO SP+

Manufacturer

POWER TOWERS

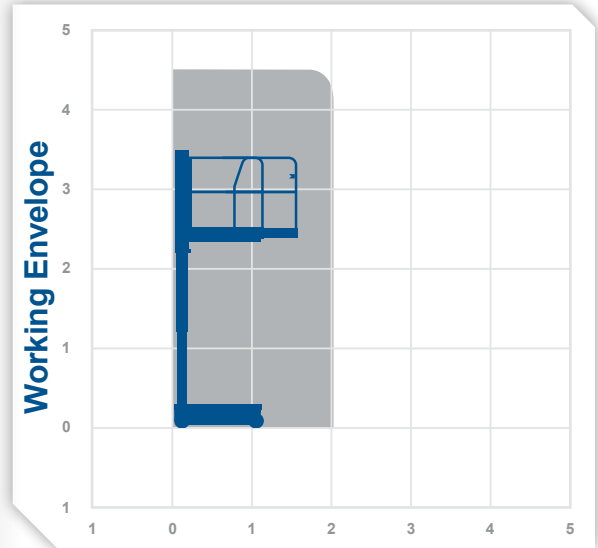

NANO SP+

low level

Working Height 4.5m

Closed Length	1.2m
Closed Height	1.59m
Closed Width	0.75m
Platform Size	1.0m x 0.73m
Platform Length – deck extended	2.0m
Max SWL	200kg
Weight	540kg

Alternative machines

NANO
NANO SP

Manufacturer

POWER TOWERS

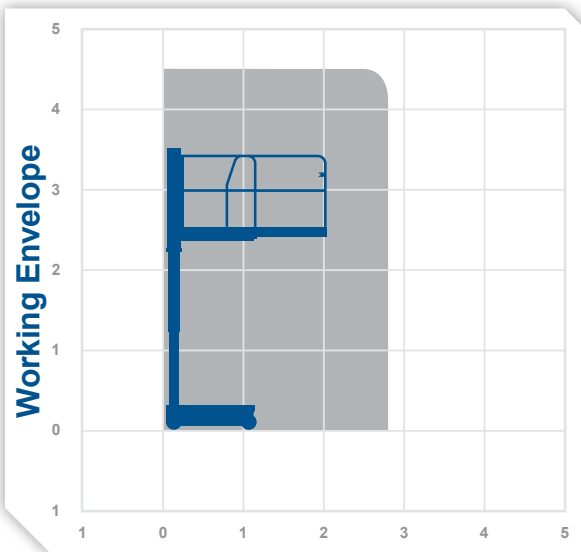

LEONARDO HD

low level

Working Height 4.9m

Closed Length	1.04m
Closed Height	1.75m
Closed Width	0.76m
Platform Size	1.04m x 0.63m
Platform Length – deck extended	1.7m
Max SWL	180kg
Weight	555kg
Weight (with Solo-Gyps)	600kg

Manufacturer
Bravi Platforms

Fitted with
Solo-Gyps
attachment
as standard

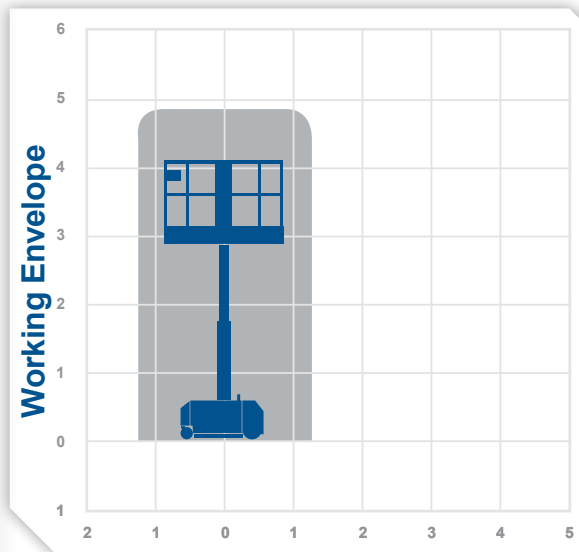

0345 745 0000
nationwideplatforms.co.uk



 Nationwide Platforms
A Loxam Company

Working Height 5.1m

Closed Length	1.6m
Closed Height	1.92m
Closed Width	0.78m
Platform Size	1.52m x 0.65m
Max SWL	250kg
Weight	342kg

Alternative machines

NANO
NANO SP

Manufacturer

POWER TOWERS

Indoor use only

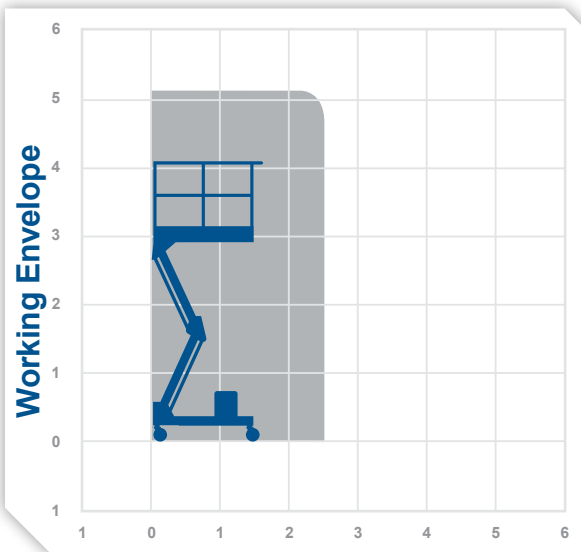

Working Height 5.58m

Closed Length	1.35m
Closed Height	1.79m
Closed Width	0.76m
Platform Size	0.89m x 0.75m
Platform Length - deck extended	1.35m
Max SWL	227kg
Weight	862kg

Alternative machines

NANO SP
GR15

Manufacturer

Genie

Indoor use only

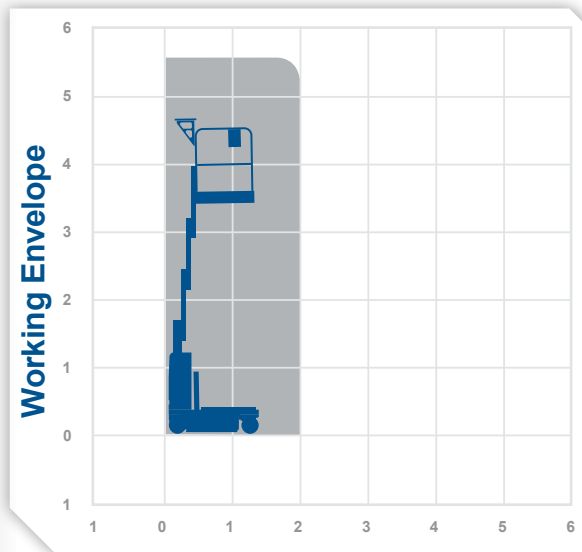

0345 745 0000
nationwideplatforms.co.uk



Nationwide Platforms
A **LOXAM** Company

SJ12

low level

Working Height 5.65m

Closed Length	1.78m
Closed Height	1.79m
Closed Width	0.77m
Platform Size	0.93m x 0.69m
Max SWL	227kg
Weight	863kg

Alternative machines

GR12
GR15

Manufacturer

Skyjack

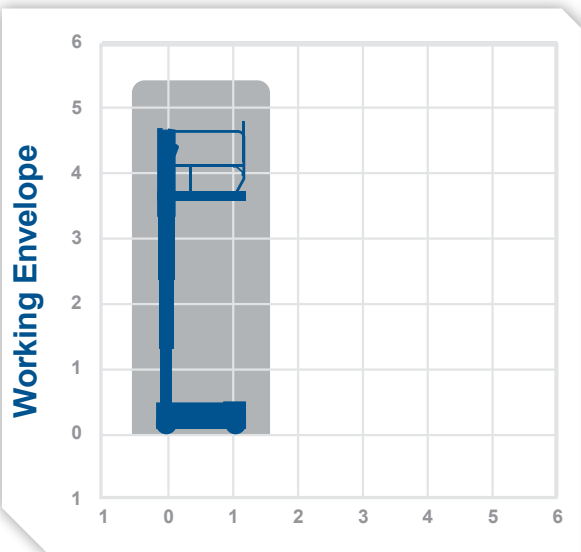

0345 745 0000
nationwideplatforms.co.uk



GR15

low level

Working Height 6.62m

Closed Length	1.45m
Closed Height	1.79m
Closed Width	0.76m
Platform Size	0.94m x 0.75m
Platform Length – deck extended	1.4m
Max SWL	227kg
Weight	994kg

Alternative machines

GR20
GR12
NANO SP

Manufacturer

Genie

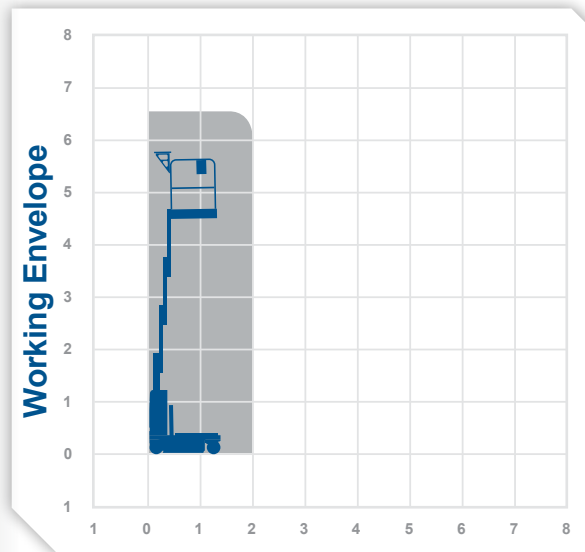

Nationwide Platforms
A Loxam Company

SJ16

low level

Working Height 6.75m

Closed Length	1.37m
Closed Height	1.79m
Closed Width	0.77m
Platform Size	0.69m x 0.85m
Max SWL	227kg
Weight	980kg

Alternative machines

GR15
GR20
1230ES

Manufacturer

Skyjack

Indoor use only

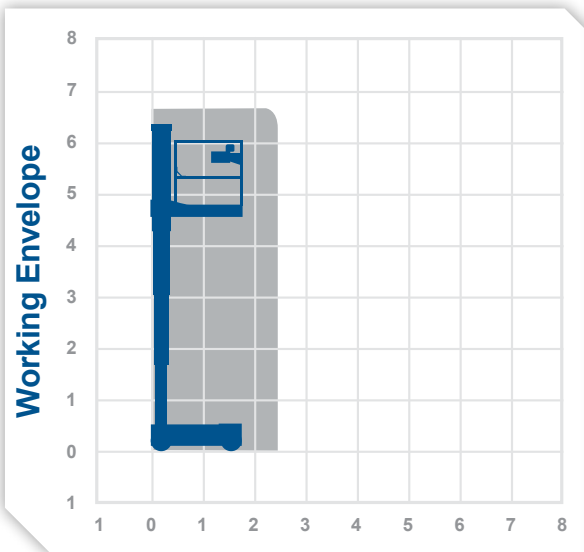

0345 745 0000
nationwideplatforms.co.uk

GR20

low level

Working Height 7.85m

Closed Length	1.35m
Closed Height	1.98m
Closed Width	0.8m
Platform Size	0.89m x 0.75m
Platform Length – deck extended	1.4m
Max SWL	159kg
Weight	1264kg

Alternative machines

GR15
GS20
3219

Manufacturer

Genie

Indoor use only

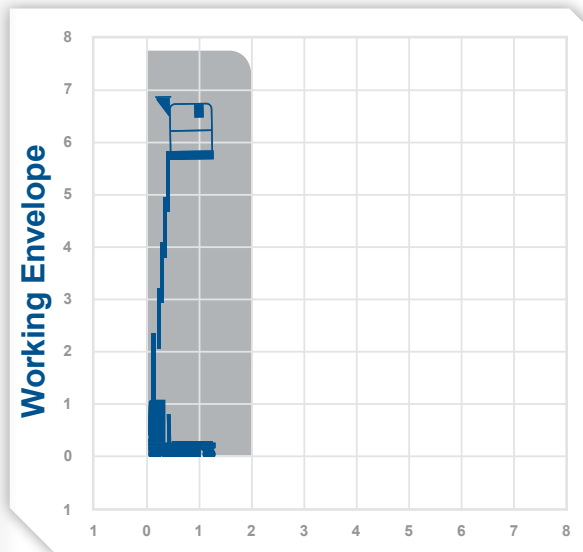

Nationwide Platforms
A Loxam Company



GP20

low level

Working Height 8.12m

Closed Length	1.27m
Closed Height	1.98m
Closed Width	0.74m
Platform Size	1.14m x 0.66m
Max SWL	159kg
Weight	347kg

Alternative machines

GP25

Manufacturer

Genie

Indoor use only

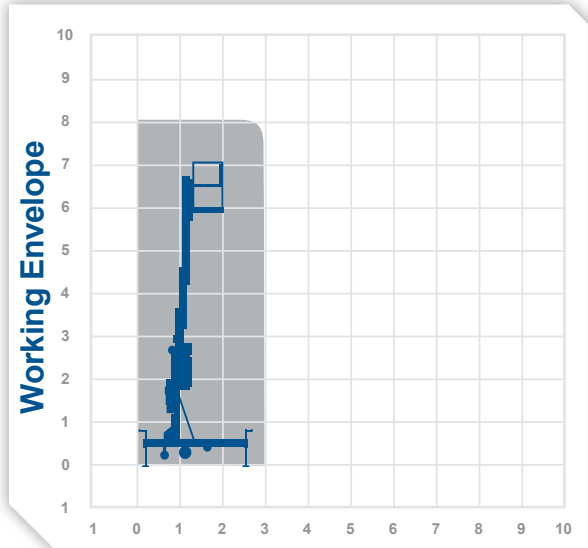

GP25

Working Height 9.54m

Closed Length	1.31m
Closed Height	1.98m
Closed Width	0.74m
Platform Size	1.14m x 0.66m
Max SWL	159kg
Weight	330kg

Alternative machines

GP20

Manufacturer

Genie

Indoor use only

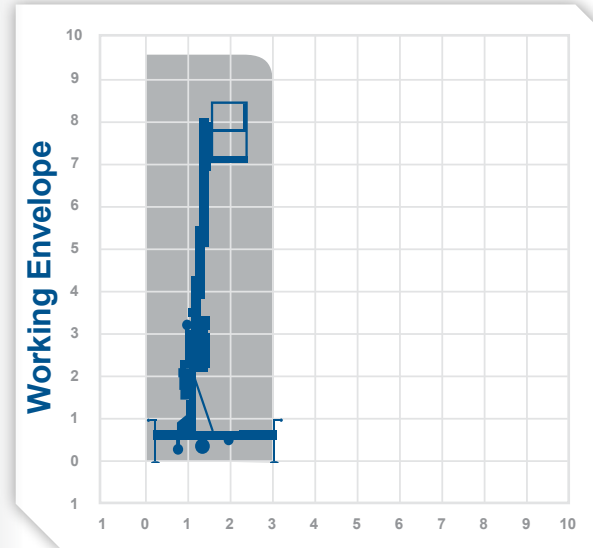

8.12m

9.54m



You can find the latest promotions, competitions and news from Nationwide Platforms by following us on our social media pages.



Nationwide Platforms
A **LOXAM** Company

Scissors



- More than 7,200 units available to hire across the UK
- Working heights from 7m to 34m
- Lightweight and compact machines
- Direct drive electric machines for greater efficiency
- Double deck and rough terrain
- Variety of power options
- Narrow aisle machines for access to confined areas
- Non-marking tyre option for work on finished floors
- Models with 1,134kg SWL
- Lightweight models from 1,269kg
- Power to platform available

Machine type by product code

GS1532	GS2632	COM12DX	GS53
SJ3215	COM10N	GS4047	GS53G
OPT8	CO10	COM14	165-12
3219	COM10DX	M4069	195-12
GS1932	6832D	S142-12	HL220H
GS20	4632	9241	HL220D
3220	GS32	8841	S225-24
COM8	GS3232	GS43	SL210
GS26	GS32D-O	GS43G	HL235D
GS2669RT	GS3369RT	S152-12	M250
4626	COM12	9250X	HL275H
6826D	GS33	LL15N	S280-25
GS26D-O	GS3390RT	S175-12	LL26X
3226	GS3390G	H18SX	HL340D

0345 745 0000
nationwideplatforms.co.uk



Nationwide Platforms
 A **LOXAM** Company

GS1532

scissors

Working Height 6.4m

Closed Length	1.83m
Closed Height	2.03m
Stowed Height (guardrails lowered)	1.73m
Closed Width	0.81m
Platform Size	1.63m x 0.74m
Platform Length (deck extended)	2.54m
Max SWL	272kg
Weight	1269kg

Alternative machines

3215
3219
GS1932

Manufacturer

Genie

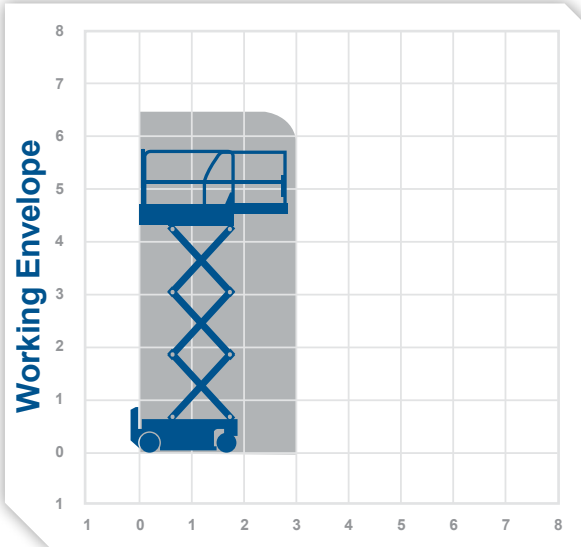

SJ3215

scissors

Working Height 6.57m

Closed Length	1.55m
Closed Height	2.03m
Stowed Height (guardrails lowered)	1.67m
Closed Width	0.81m
Platform Size	1.55m x 0.66m
Platform Length (deck extended)	2.46m
Max SWL	272kg
Weight	1148kg

Alternative machines

GS1532

Manufacturer

SkyJack

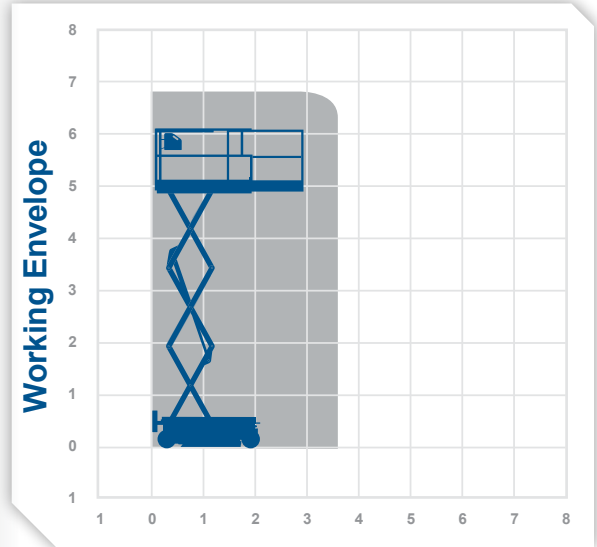

0345 745 0000
nationwideplatforms.co.uk



Nationwide Platforms
A **LOXAM** Company

Working Height 7.77m

Closed Length	1.9m
Closed Height	1.98m
Stowed Height (guardrails lowered)	1.98m
Closed Width	0.79m
Platform Size	0.74m x 1.72m
Platform Length (deck extended)	2.59m
Max SWL	230kg
Weight	1520g

Alternative machines

3220
GS1932
GS20

Manufacturer

Haulotte

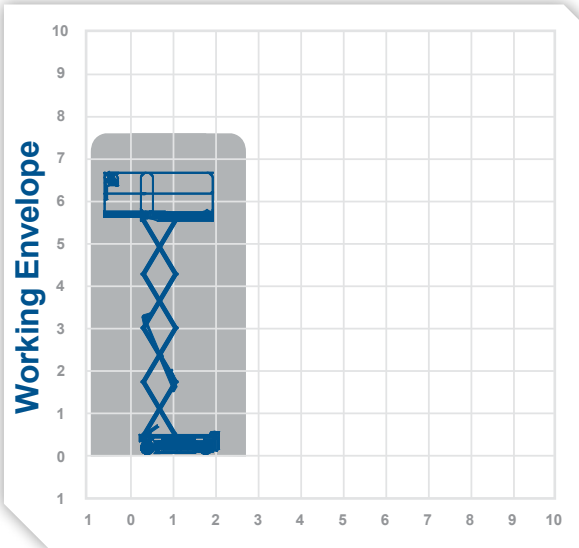

0345 745 0000
nationwideplatforms.co.uk

**Working Height 7.8m**

Closed Length	1.78m
Closed Height	2.11m
Stowed Height (guardrails lowered)	1.64m
Closed Width	0.81m
Platform Size	1.63m x 0.71m
Platform Length (deck extended)	2.53m
Max SWL	227kg
Weight	1312kg

Alternative machines

GS1932
GS20

Manufacturer

SkyJack

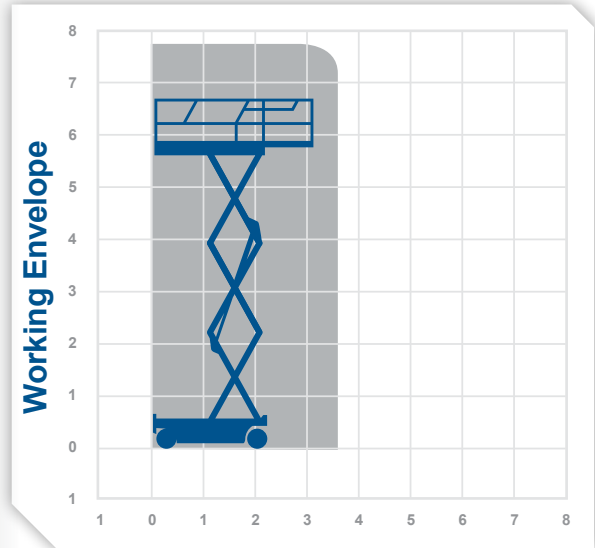

Nationwide Platforms
A **LOXAM** Company

GS1932

scissors

Working Height 7.8m

Closed Length	1.82m
Closed Height	2.11m
Stowed Height (guardrails lowered)	1.76m
Closed Width	0.81m
Platform Size	1.64m x 0.74m
Platform Length (deck extended)	2.54m
Max SWL	227kg
Weight	1503kg

Alternative machines

3219
GS20
3220

Manufacturer

Genie

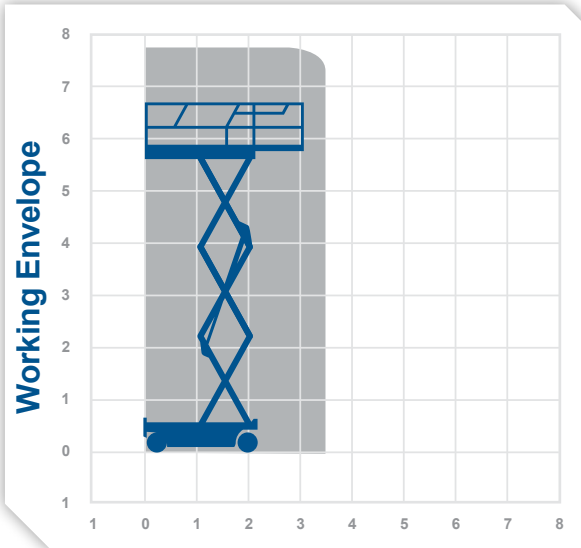

0345 745 0000
nationwideplatforms.co.uk

GS20

scissors

Working Height 7.92m

Closed Length	2.45m
Closed Height	2.1m
Stowed Height (guardrails lowered)	1.75m
Closed Width	0.81m
Platform Size	2.21m x 0.7m
Platform Length (deck extended)	3.2m
Max SWL	363kg
Weight	1559kg

Alternative machines

3220
COM8

Manufacturer

Genie

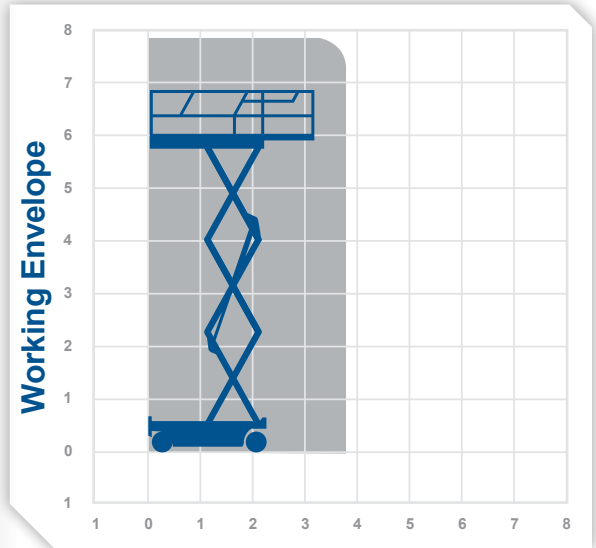

Nationwide Platforms
A Loxam Company



Working Height 8.1m

Closed Length	2.32m
Closed Height	2.08m
Stowed Height (guardrails lowered)	1.73m
Closed Width	0.81m
Platform Size	2.13m x 0.71m
Platform Length (deck extended)	3.04m
Max SWL	408kg
Weight	1594kg

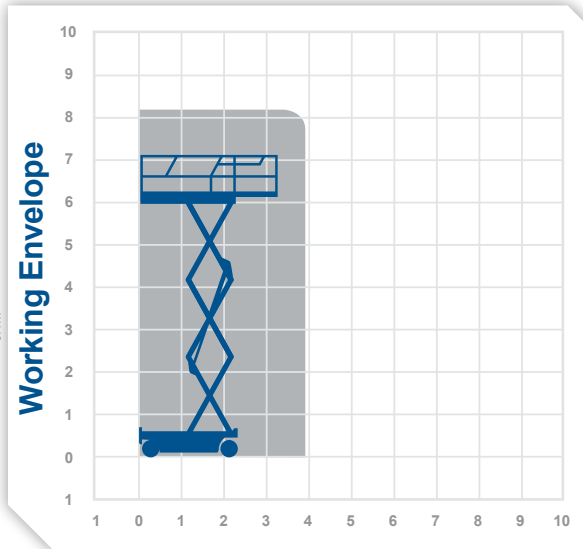
Alternative machinesGS20
2030ES**Manufacturer**
SkyJack**Working Height 8.2m**

Closed Length	2.49m
Closed Height	2.0m
Stowed Height (guardrails lowered)	1.13m
Closed Width	0.81m
Platform Size	0.81m x 2.31m
Platform Length (deck extended)	3.23m
Max SWL	350kg
Weight	1655kg

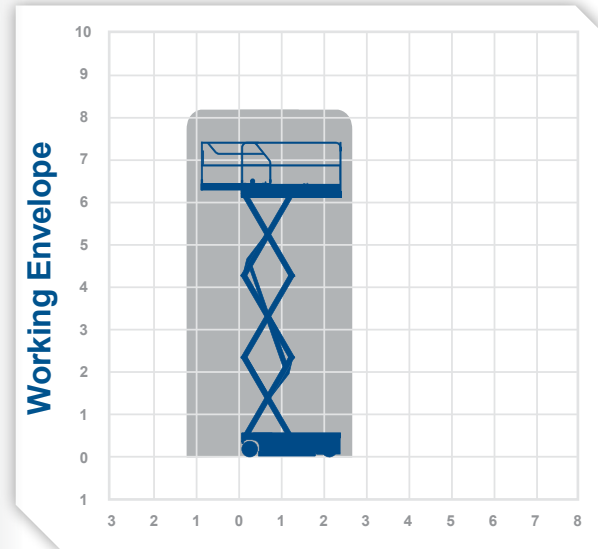
Alternative machinesGS26
GS2632
3226**Manufacturer**
Haulotte

0345 745 0000
nationwideplatforms.co.uk



Nationwide Platforms
A **LOXAM** Company

GS26

scissors

Working Height 9.75m

Closed Length	2.45m
Closed Height	2.17m
Stowed Height (guardrails lowered)	1.99m
Closed Width	1.17m
Platform Size	2.21m x 0.94m
Platform Length (deck extended)	3.2m
Max SWL	454kg
Weight	2107kg

Alternative machines

4626

Manufacturer

Genie

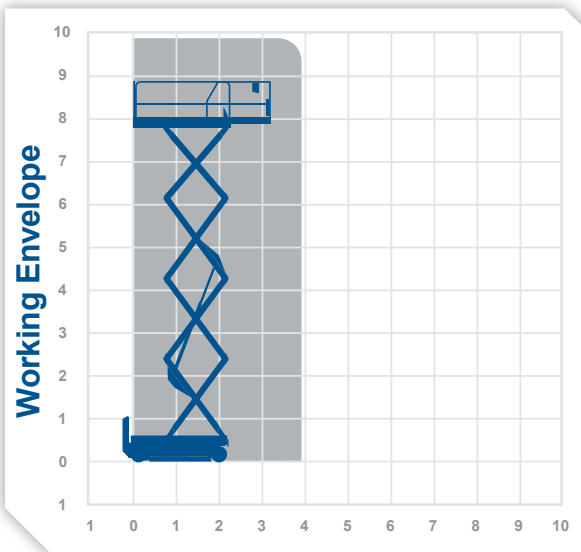

0345 745 0000
nationwideplatforms.co.uk



GS2669RT

scissors

Working Height 9.9m

Closed Length	3.12m
Closed Height	2.59m
Stowed Height (guardrails lowered)	1.92m
Closed Width	1.75m
Platform Size	2.79m x 1.6m
Platform Length (deck extended)	4.5m
Max SWL	680kg
Weight	3768kg

Alternative machines

GS26D-O
6826D

Manufacturer

Genie

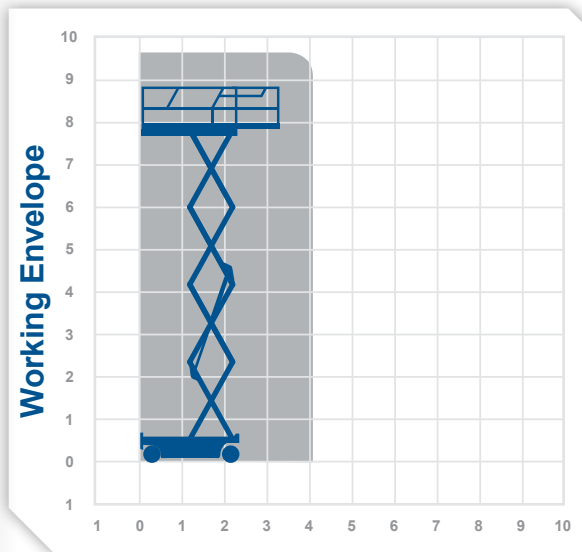

Nationwide Platforms
 A **LOXAM** Company

4626

scissors

Working Height 9.9m

Closed Length	2.31m
Closed Height	2.15m
Stowed Height (guardrails lowered)	1.79m
Closed Width	1.17m
Platform Size	2.11m x 1.07m
Platform Length (deck extended)	3.01m
Max SWL	454kg
Weight	2130kg

Alternative machines

GS26

Manufacturer

SkyJack

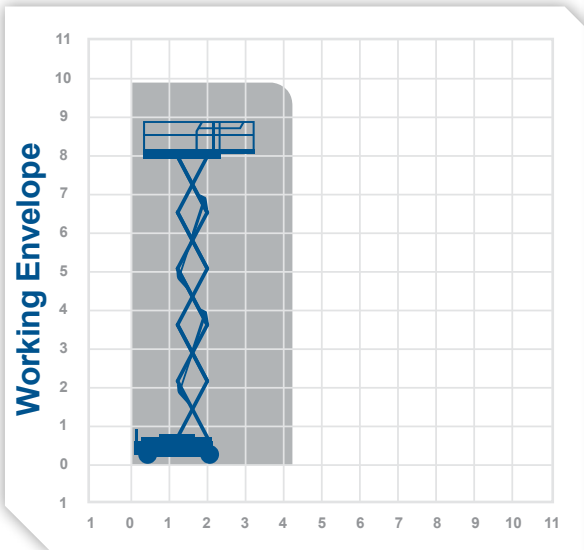

0345 745 0000
nationwideplatforms.co.uk

6826D

scissors

Working Height 9.92m

Closed Length	3.12m
Closed Height	2.37m
Stowed Height (guardrails lowered)	1.61m
Closed Width	1.72m
Platform Size	2.44m x 1.42m
Platform Length (deck extended)	3.94m
Max SWL	567kg
Weight	3305kg

Alternative machines

GS26D
GS26D-O

Manufacturer

SkyJack

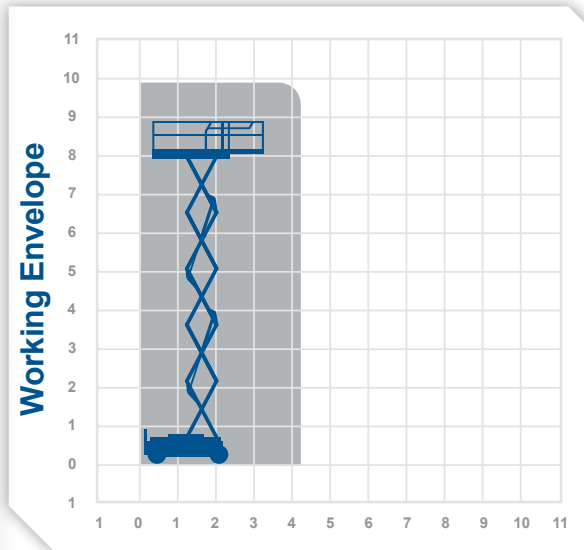

Nationwide Platforms
 A **LOXAM** Company



Working Height 9.92m

Closed Length	2.67m
Closed Height	2.35m
Stowed Height (guardrails lowered)	1.7m
Closed Width	1.73m
Platform Size	2.51m x 1.55m
Platform Length (deck extended)	3.96m
Max SWL	567kg
Weight	3455kg

Alternative machines

GS26D
6826D

Manufacturer

Genie

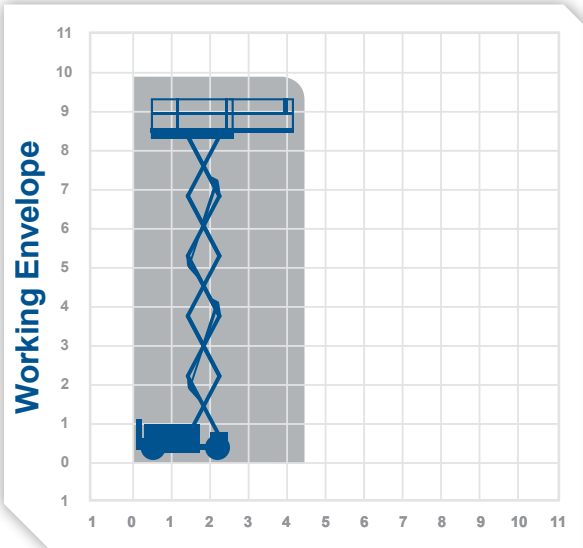

0345 745 0000
nationwideplatforms.co.uk



Working Height 9.92m

Closed Length	2.32m
Closed Height	2.15m
Stowed Height (guardrails lowered)	1.91m
Closed Width	0.81m
Platform Size	2.13m x 0.71m
Platform Length (deck extended)	3.23m
Max SWL	227kg
Weight	1890kg

Alternative machines

GS2632

Manufacturer

SkyJack

Indoor use only

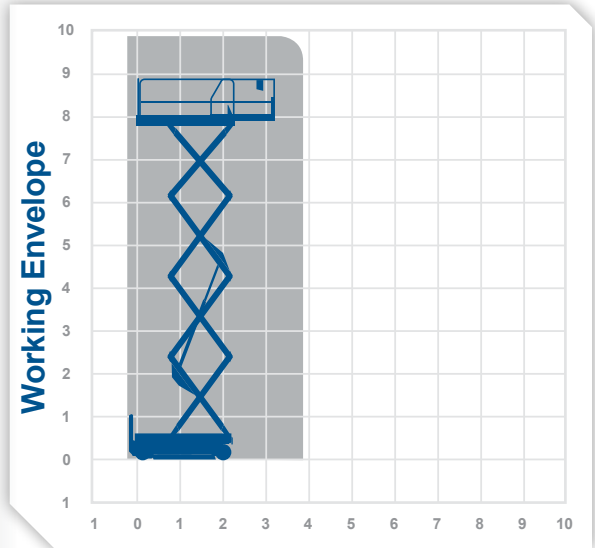

Nationwide Platforms
A **LOXAM** Company

Working Height 9.92m

Closed Length	2.44m
Closed Height	2.26m
Stowed Height (guardrails lowered)	1.91m
Closed Width	0.81m
Platform Size	2.26m x 0.79m
Platform Length (deck extended)	3.18m
Max SWL	227kg
Weight	1956kg

Alternative machines

3226
2630

Manufacturer

Genie

Indoor use only

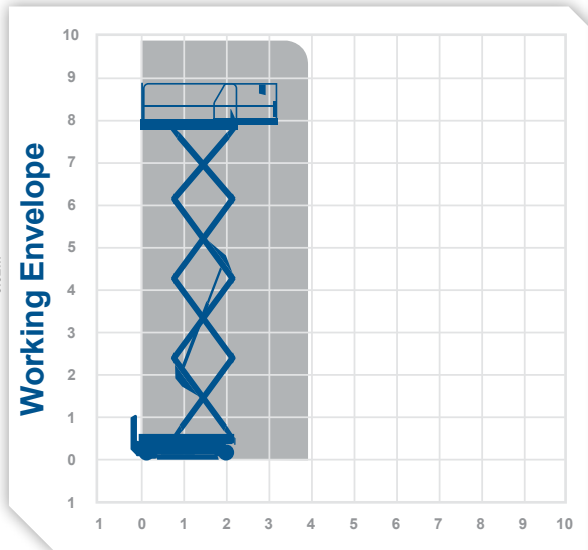

Working Height 10.0m

Closed Length	2.49m
Closed Height	2.18m
Stowed Height (guardrails lowered)	1.32m
Closed Width	0.81m
Platform Size	0.81m x 2.31m
Platform Length (deck extended)	3.23m
Max SWL	230kg
Weight	2190kg

Alternative machines

GS2632
3226

Manufacturer

Haulotte

Indoor use only

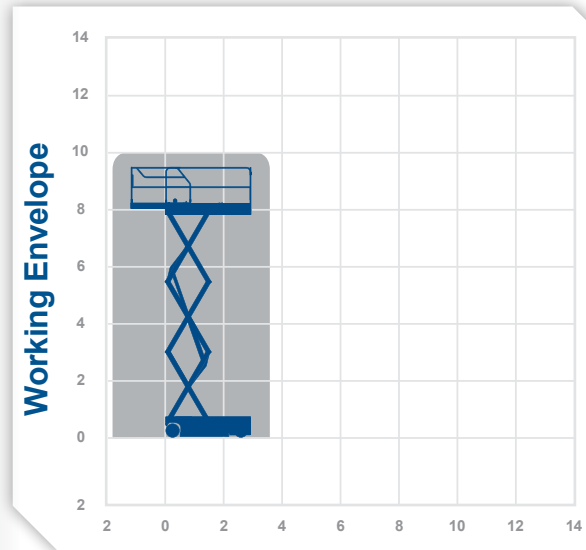

0345 745 0000
nationwideplatforms.co.uk



Nationwide Platforms
A **LOXAM** Company

COM10

scissors

Working Height 10.15m

Closed Length	2.31m
Closed Height	2.14m
Stowed Height (guardrails lowered)	1.28m
Closed Width	1.2m
Platform Size	2.31m x 1.2m
Platform Length (deck extended)	3.23m
Max SWL	450kg
Weight	2330kg

Alternative machines

GS2632
3226
COM10N

Manufacturer

Haulotte

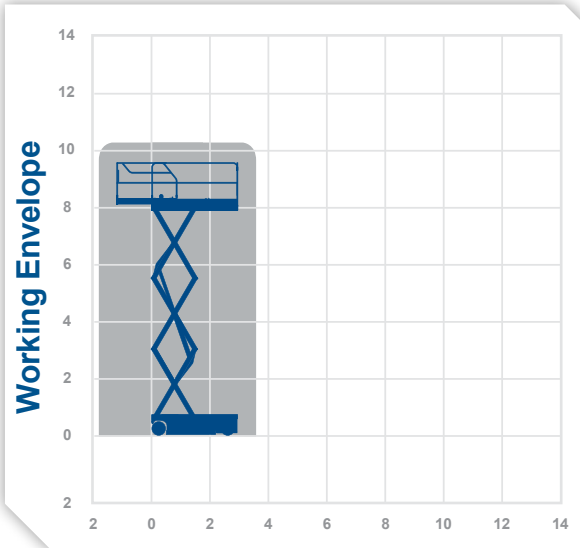

0345 745 0000
nationwideplatforms.co.uk

COM10DX

scissors

Working Height 10.3m

Closed Length	3.17m
Closed Height	2.44m
Stowed Height (guardrails lowered)	1.59m
Closed Width	1.78m
Platform Size	2.45m x 1.45m
Platform Length (deck extended)	3.7m
Max SWL	565kg
Weight	3520kg

Alternative machines

GS26D
6826D

Manufacturer

Haulotte

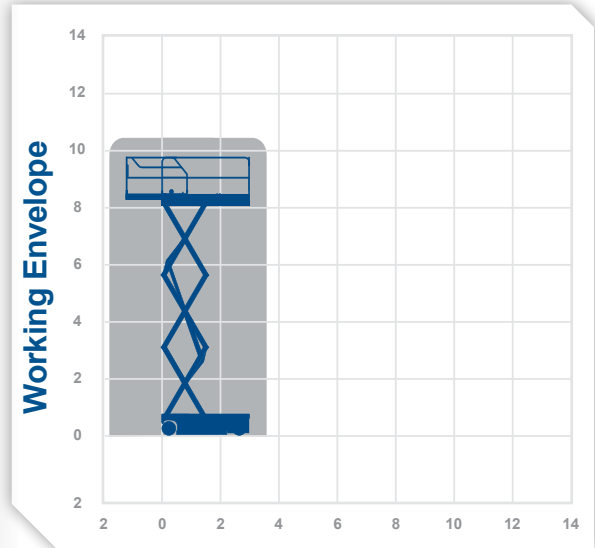

Nationwide Platforms
A Loxam Company



6832D

scissors

Working Height 11.75m

Closed Length	3.12m
Closed Height	2.51m
Stowed Height (guardrails lowered)	1.75m
Closed Width	1.72m
Platform Size	2.44m x 1.42m
Platform Length (deck extended)	3.94m
Max SWL	454kg
Weight	3655kg

Alternative machines

GS32D
GS32D-O

Manufacturer

SkyJack

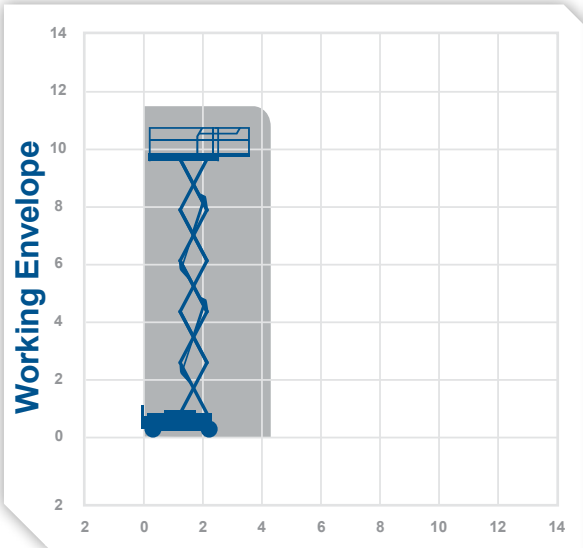

4632

scissors

Working Height 11.75m

Closed Length	2.31m
Closed Height	2.24m
Stowed Height (guardrails lowered)	1.88m
Closed Width	1.17m
Platform Size	2.11m x 1.07m
Platform Length (deck extended)	3.01m
Max SWL	317kg
Weight	2300kg

Alternative machines

GS32
3246

Manufacturer

SkyJack

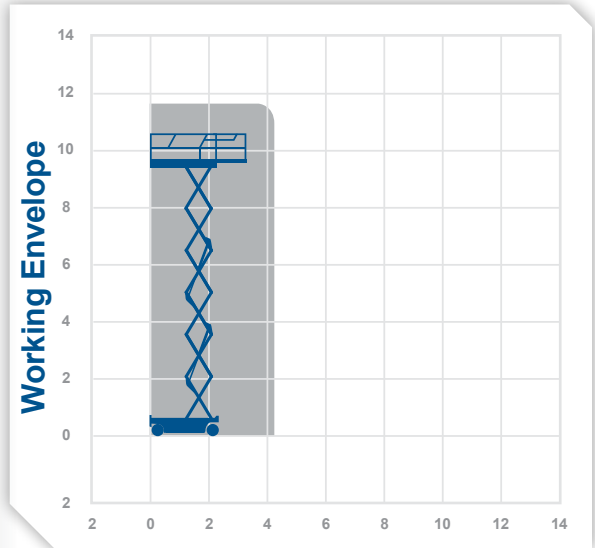

0345 745 0000
nationwideplatforms.co.uk



Nationwide Platforms
 A **LOXAM** Company

Working Height 11.75m

Closed Length	2.43m
Closed Height	2.3m
Stowed Height (guardrails lowered)	1.8m
Closed Width	1.17m
Platform Size	2.26m x 1.16m
Platform Length (deck extended)	3.25m
Max SWL	318kg
Weight	2796kg

Alternative machines

4632
3246

Manufacturer

Genie

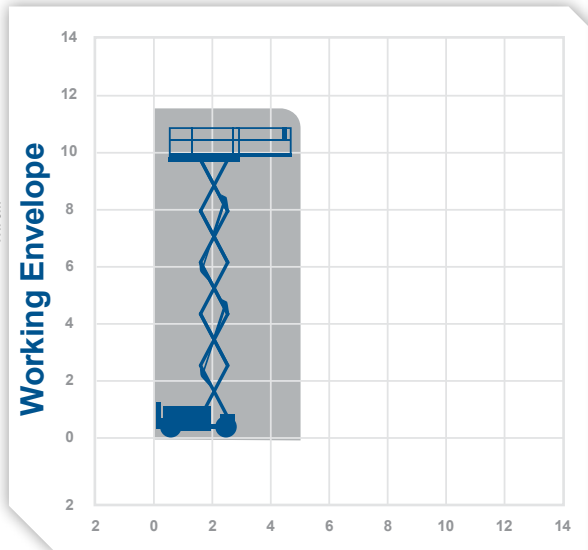

0345 745 0000
nationwideplatforms.co.uk



Working Height 11.75m

Closed Length	2.44m
Closed Height	2.44m
Stowed Height (guardrails lowered)	2.03m
Closed Width	0.81m
Platform Size	2.26m x 0.81m
Platform Length (deck extended)	3.33m
Max SWL	227kg
Weight	2352kg

Alternative machines

GS32

Manufacturer

Genie



Indoor use only

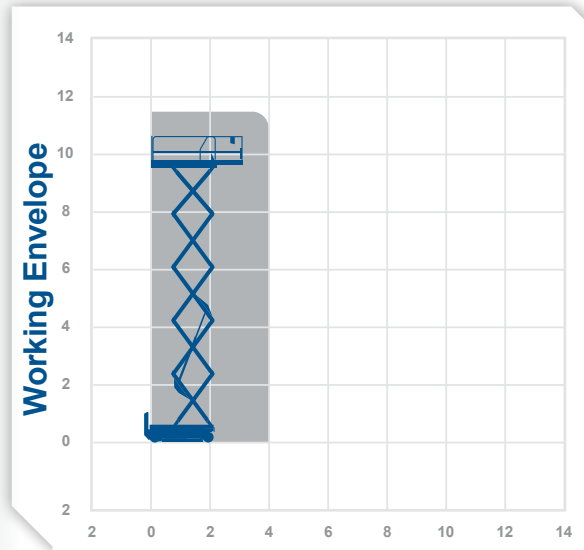

Nationwide Platforms
A **LOXAM** Company



Working Height 11.8m

Closed Length	2.67m
Closed Height	2.45m
Stowed Height (guardrails lowered)	1.83m
Closed Width	1.73m
Platform Size	2.51m x 1.55m
Platform Length (deck extended)	3.96m
Max SWL	454kg
Weight	4115kg

Alternative machines
6832D
Manufacturer
Genie

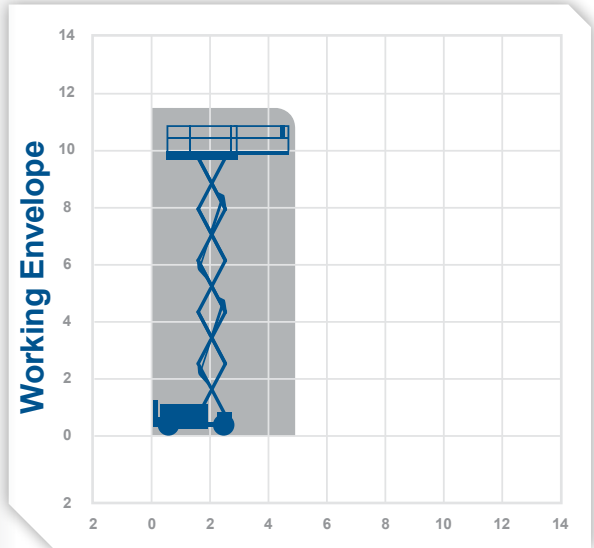

0345 745 0000
nationwideplatforms.co.uk



Nationwide Platforms
A **LOXAM** Company

11.8m

GS3369RT

scissors

Working Height 11.96m

Closed Length	3.12m
Closed Height	2.59m
Stowed Height (guardrails lowered)	1.92m
Closed Width	1.75m
Platform Size	2.79m x 1.6m
Platform Length (deck extended)	4.5m
Max SWL	454kg
Weight	3949kg

Alternative machines

6832D

Manufacturer

Genie

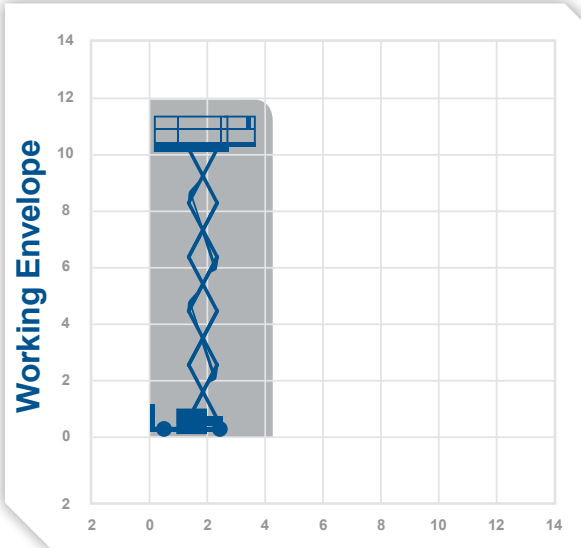

0345 745 0000
nationwideplatforms.co.uk

COM12

scissors

Working Height 12.0m

Closed Length	2.49m
Closed Height	2.39m
Stowed Height (guardrails lowered)	1.53m
Closed Width	1.2m
Platform Size	1.2m x 2.31m
Platform Length (deck extended)	3.23m
Max SWL	300kg
Weight	2470g

Alternative machines

GS32
4632

Manufacturer

Haulotte

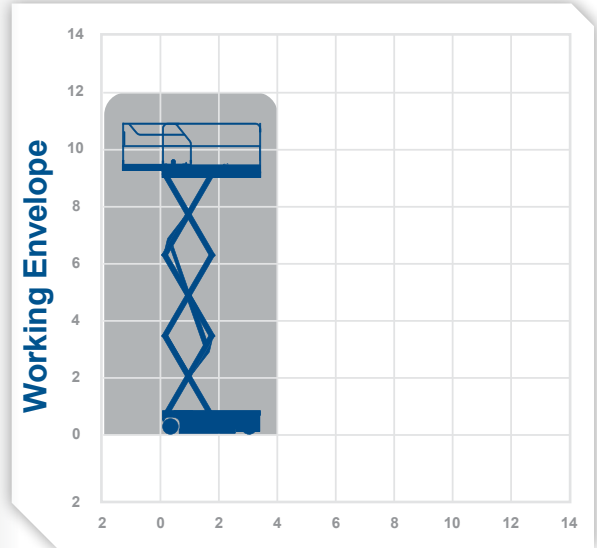

Nationwide Platforms
 A Loxam Company



Working Height 12.06m

Closed Length	4.88m
Closed Height	2.68m
Stowed Height (guardrails lowered)	2.0m
Closed Width	2.13m
Platform Size	3.89m x 1.83m
Platform Length (deck extended)	6.57m
Max SWL	1134kg
Weight	7520kg

Alternative machines

GS3390RT
GS43
6832D
GS3369RT

Manufacturer

Genie

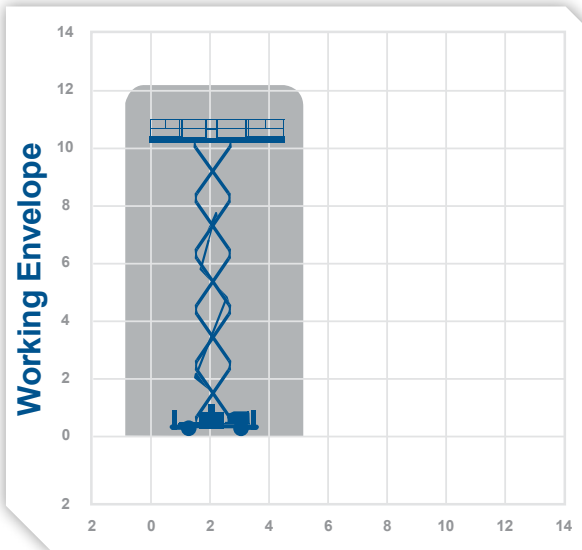

Working Height 12.06m

Closed Length	4.88m
Closed Height	2.71m
Stowed Height (guardrails lowered)	2.03m
Closed Width	2.29m
Platform Size	4.81m x 1.83m
Platform Length (deck extended)	7.38m
Max SWL	1134kg
Weight	6890kg

Alternative machines

GS33
GS43
6832D
GS3369RT

Manufacturer

Genie

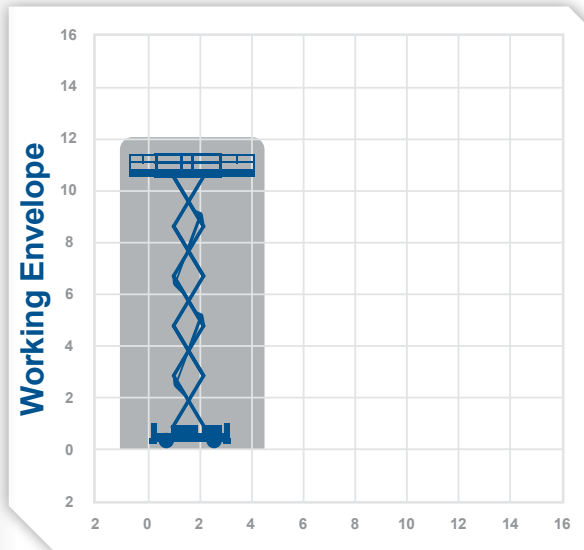

One day of powered access training,
years of working safely at height.
Call today and get trained with
Nationwide Platforms.
Call: 0345 745 0000



GS3390G

scissors

Working Height 12.06m

Closed Length	4.88m
Closed Height	2.71m
Stowed Height (guardrails lowered)	2.03m
Closed Width	2.29m
Platform Size	4.81m x 1.83m
Platform Length (deck extended)	7.38m
Max SWL	1134kg
Weight	6826kg

Alternative machines

GS43G
GS53G

Manufacturer

Genie

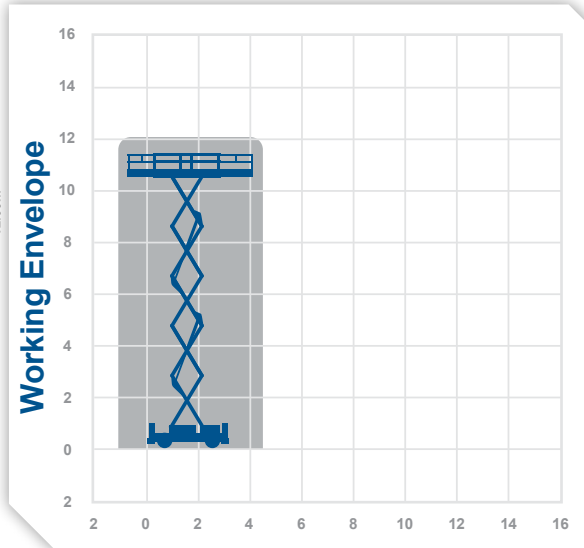

COM12DX

scissors

Working Height 12.06m

Closed Length	3.17m
Closed Height	2.56m
Stowed Height (guardrails lowered)	1.7m
Closed Width	1.78m
Platform Size	1.78m x 2.45m
Platform Length (deck extended)	3.7m
Max SWL	450kg
Weight	4110kg

Alternative machines

GS3369RT
GS32D-O

Manufacturer

Haulotte

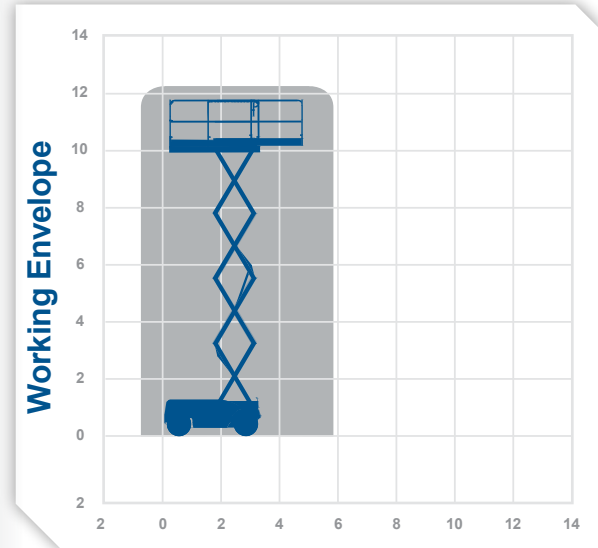

0345 745 0000
nationwideplatforms.co.uk



Nationwide Platforms
A **LOXAM** Company

GS4047

scissors

Working Height 13.7m

Closed Length	2.44m
Closed Height	2.54m
Stowed Height (guardrails lowered)	1.88m
Closed Width	1.19m
Platform Size	2.26m x 1.15m
Platform Length (deck extended)	3.36m
Max SWL	350kg
Weight	3221kg

Alternative machines

COM14
S142-12
S152-12

Manufacturer

Genie

Indoor use only

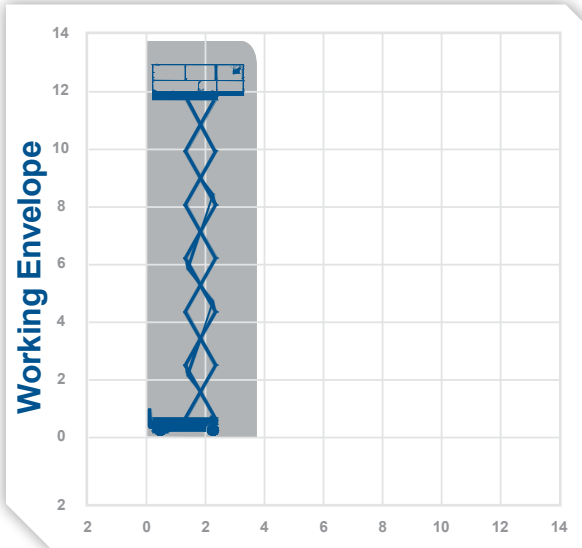

COM14

scissors

Working Height 13.8m

Closed Length	2.74m
Closed Height	2.5m
Stowed Height (guardrails lowered)	2.08m
Closed Width	1.2m
Platform Size	2.3m x 1.2m
Platform Length (deck extended)	3.22m
Max SWL	350kg
Weight	3175kg

Alternative machines

LL15N
S142-12
S152-12

Manufacturer

Haulotte

Indoor use only

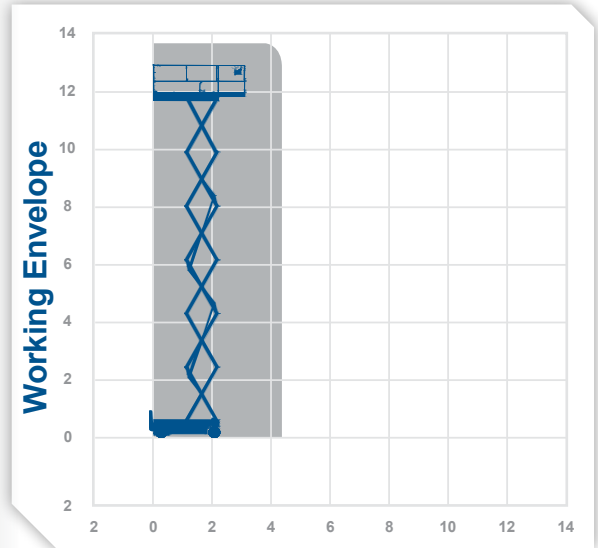

0345 745 0000
nationwideplatforms.co.uk



Nationwide Platforms
A Loxam Company

M4069

scissors

Working Height 14.19m

Closed Length	3.1m
Closed Height	2.83m
Stowed Height (guardrails lowered)	2.01m
Closed Width	1.75m
Platform Size	2.92m x 1.65m
Platform Length (deck extended)	3.83m
Max SWL	360kg
Weight	5700kg

Alternative machines

4069
4069-O

Manufacturer

JLG

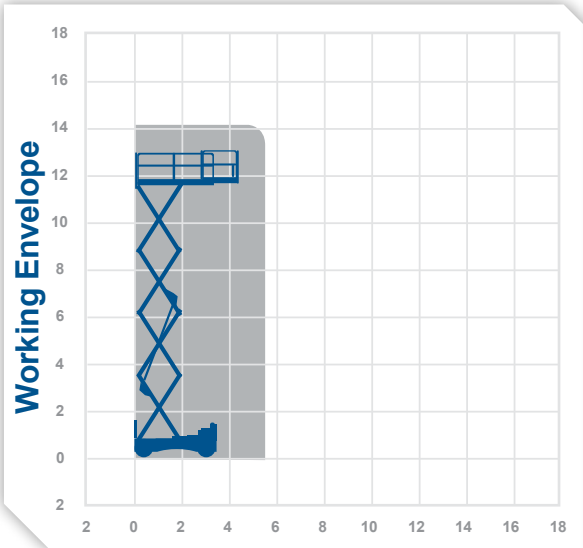

0345 745 0000
nationwideplatforms.co.uk



S142-12

scissors

Working Height 14.2m

Closed Length	2.71m
Closed Height	2.76m
Stowed Height (guardrails lowered)	1.98m
Closed Width	1.2m
Platform Size	2.5m x 1.2m
Platform Length (deck extended)	3.7m
Max SWL	350kg
Weight	3400kg

Alternative machines

S152-12
COM14
GS4047

Manufacturer

HAB

Indoor use only

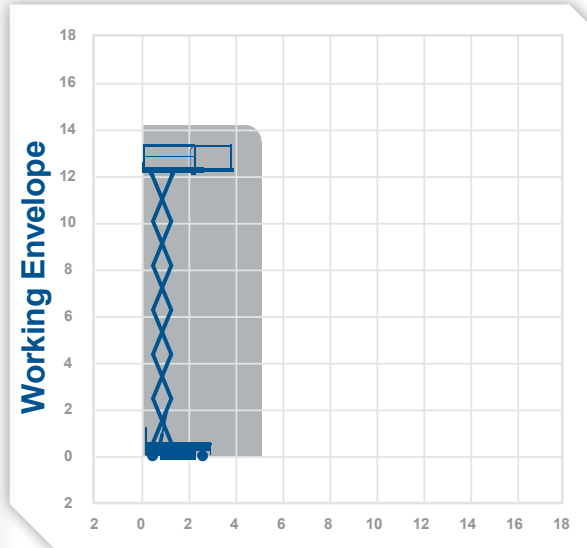

Nationwide Platforms
A **LOXAM** Company

Working Height 14.5m

Closed Length	4.5m
Closed Height	2.8m
Stowed Height (guardrails lowered)	2.0m
Closed Width	2.3m
Platform Size	4.30m x 1.90m
Platform Length (deck extended)	7.2m
Max SWL	681kg
Weight	6715kg

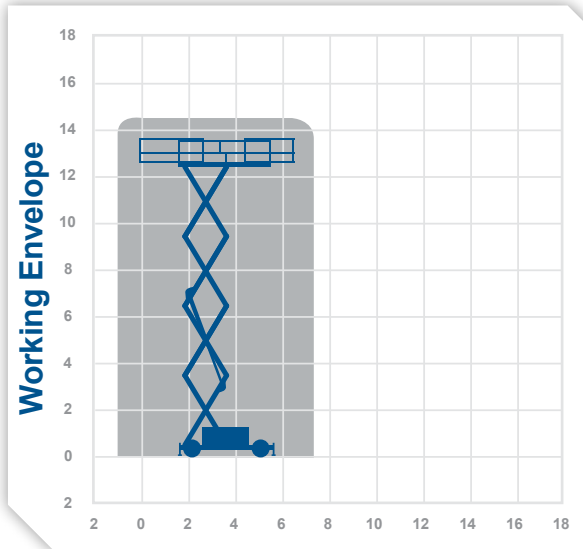
Alternative machines8841
GS43**Manufacturer**
SkyJack

0345 745 0000
nationwideplatforms.co.uk

**Working Height 14.5m**

Closed Length	3.49m
Closed Height	2.9m
Stowed Height (guardrails lowered)	2.22m
Closed Width	2.21m
Platform Size	3.51m x 1.76m
Platform Length (deck extended)	4.71m
Max SWL	680kg
Weight	5289kg

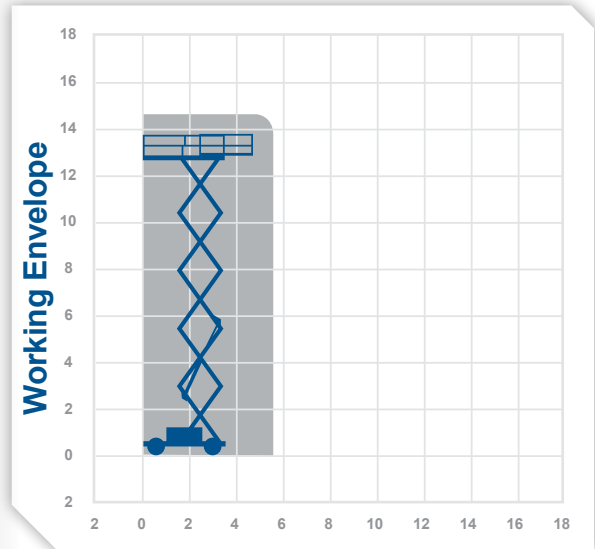
Alternative machines9241
GS43**Manufacturer**
SkyJack

Nationwide Platforms
A **LOXAM** Company

Working Height 15.1m

Closed Length	4.88m
Closed Height	2.93m
Stowed Height (guardrails lowered)	2.25m
Closed Width	2.29m
Platform Size	4.81m x 1.83m
Platform Length (deck extended)	7.38m
Max SWL	680kg
Weight	7323kg

Alternative machines

8841
9241
GS53

Manufacturer

Genie

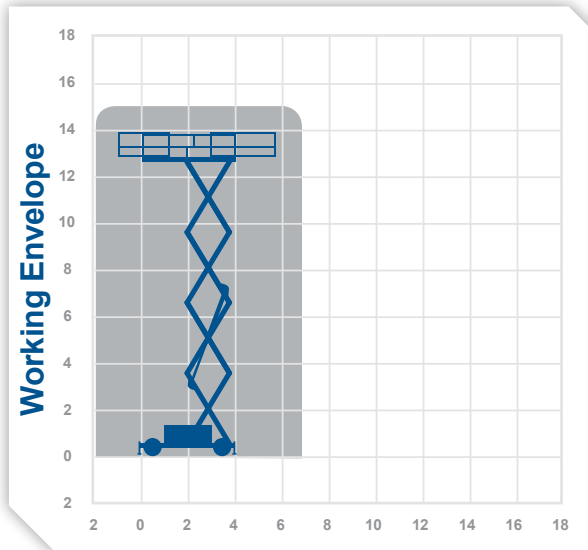

Working Height 15.1m

Closed Length	4.88m
Closed Height	2.93m
Stowed Height (guardrails lowered)	2.25m
Closed Width	2.29m
Platform Size	4.81m x 1.83m
Platform Length (deck extended)	7.38m
Max SWL	680kg
Weight	7323kg

Alternative machines

GS53G

Manufacturer

Genie

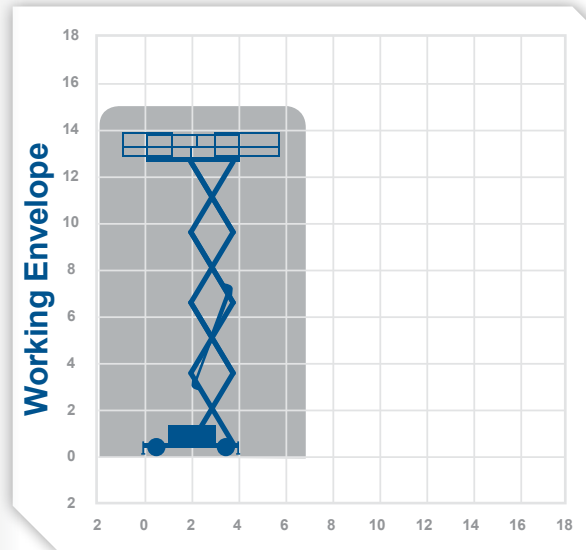

0345 745 0000
nationwideplatforms.co.uk



Nationwide Platforms
A **LOXAM** Company

S152-12

scissors

Working Height 15.2m

Closed Length	3.35m
Closed Height	3.0m
Stowed Height (guardrails lowered)	2.25m
Closed Width	1.19m
Platform Size	3.04m x 1.18m
Platform Length (deck extended)	4.24m
Max SWL	500kg
Weight	4700kg

Alternative machines

LL15N
GS4047
COM14
S142-12

Manufacturer

HAB

Indoor use only

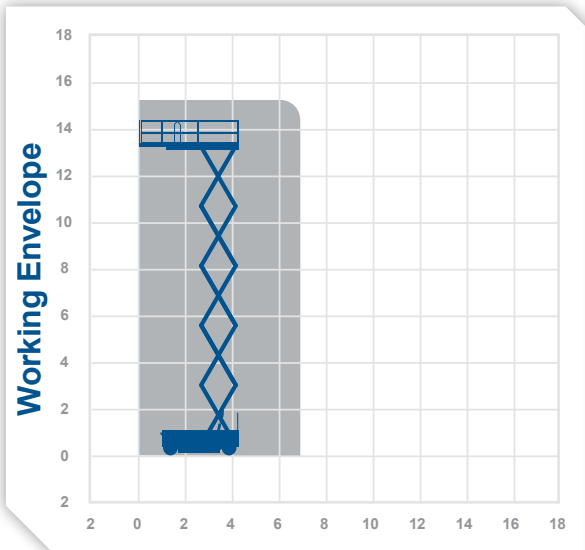

9250X

scissors

Working Height 17.2m

Closed Length	4.47m
Closed Height	3.16m
Stowed Height (guardrails lowered)	2.29m
Closed Width	2.34m
Platform Size	4.27m x 1.88m
Platform Length (deck extended)	7.2m
Max SWL	681kg
Weight	7395kg

Alternative machines

9250X-O
GS53

Manufacturer

SkyJack

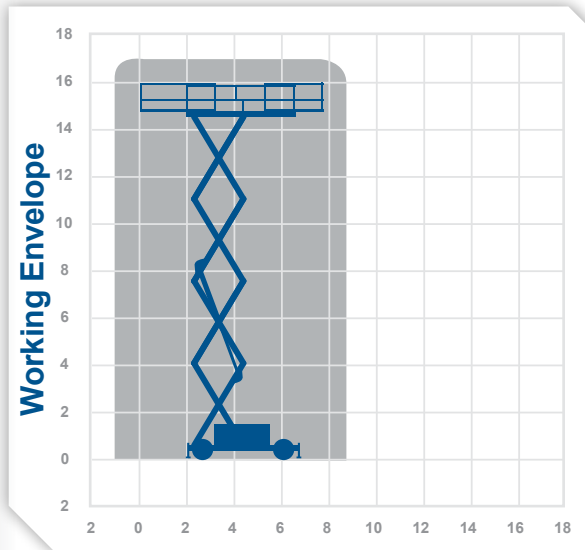

0345 745 0000
nationwideplatforms.co.uk



Nationwide Platforms
A **LOXAM** Company

LL15N

scissors

Working Height 17.3m

Closed Length	4.12m
Closed Height	3.3m
Stowed Height (guardrails lowered)	2.55m
Closed Width	1.22m
Platform Size	3.9m x 1.2m
Platform Length (deck extended)	5.4m
Max SWL	500kg
Weight	7600kg

Alternative machines

S152-12
S175-12
165-12
LL17E

Manufacturer

Liftlux

Indoor use only

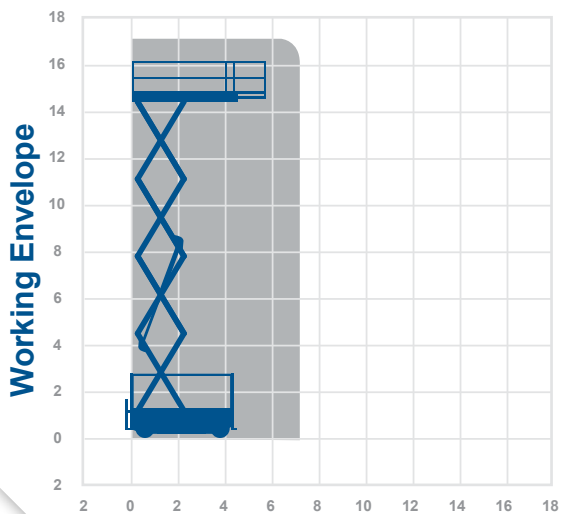

0345 745 0000
nationwideplatforms.co.uk

S175-12

scissors

Working Height 17.5m

Closed Length	3.34m
Closed Height	3.15m
Stowed Height (guardrails lowered)	2.38m
Closed Width	1.19m
Platform Size	3.04m x 1.18m
Platform Length (deck extended)	4.25m
Max SWL	500kg
Weight	5350kg

Alternative machines

LL15N
S175-12
165-12

Manufacturer

HAB

Indoor use only

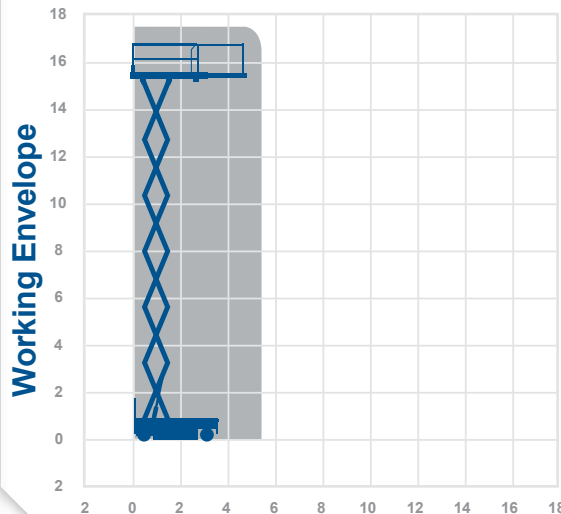

Nationwide Platforms
A LOXAM Company



H18SX

scissors

Working Height 18.0m

Closed Length	5.3m
Closed Height	2.99m
Stowed Height (guardrails lowered)	2.11m
Closed Width	2.25m
Platform Size	1.89m x 5.3m
Platform Length (deck extended)	7.3m
Max SWL	500kg
Weight	7360g

Alternative machines

GS53

Manufacturer

Haulotte

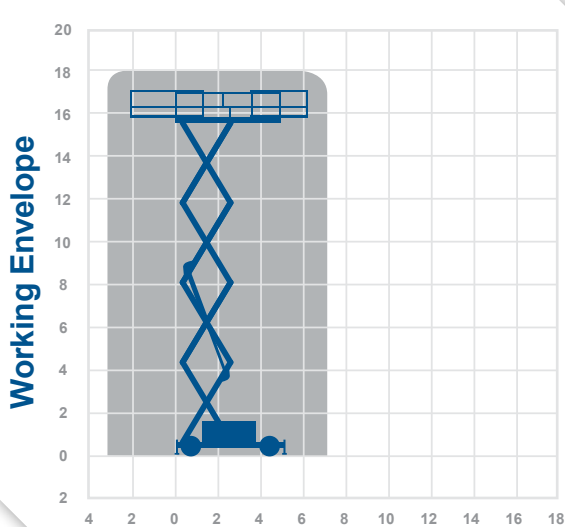

0345 745 0000
nationwideplatforms.co.uk



GS53

scissors

Working Height 18.15m

Closed Length	4.88m
Closed Height	3.15m
Stowed Height (guardrails lowered)	2.47m
Closed Width	2.29m
Platform Size	4.81m x 1.83m
Platform Length (deck extended)	7.38m
Max SWL	680kg
Weight	8050kg

Alternative machines

LL20X
9250X
9250

Manufacturer

Genie

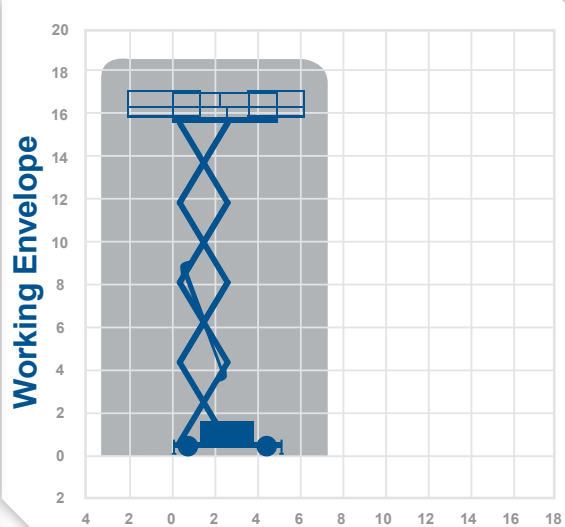

Nationwide Platforms
 A **LOXAM** Company

Working Height 18.2m

Closed Length	3.98m
Closed Height	3.15m
Stowed Height (guardrails lowered)	2.47m
Closed Width	2.29m
Platform Size	4.81m x 1.83m
Platform Length (deck extended)	7.38m
Max SWL	680kg
Weight	9541kg

Alternative machines

GS43G

Manufacturer

Genie

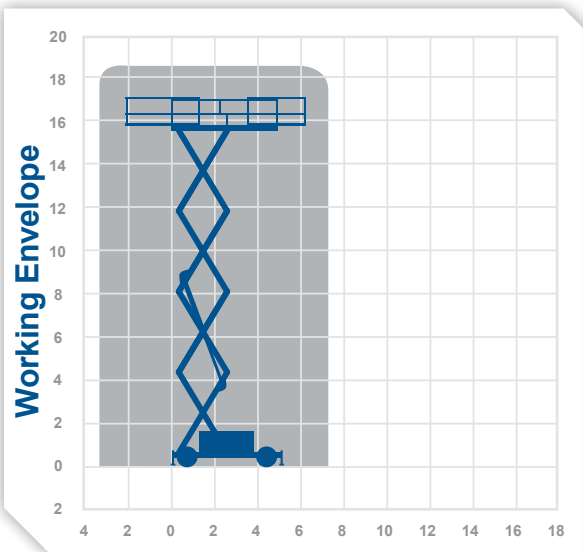

0345 745 0000
nationwideplatforms.co.uk

Working Height 18.5m

Closed Length	3.74m
Closed Height	3.4m
Stowed Height (guardrails lowered)	2.65m
Closed Width	1.2m
Platform Size	3.38m x 1.16m
Platform Length (deck extended)	4.88m
Max SWL	500kg
Weight	7985kg

Alternative machines

LL15N
S175-12
180-12
LL15N

Manufacturer

Holland Lift

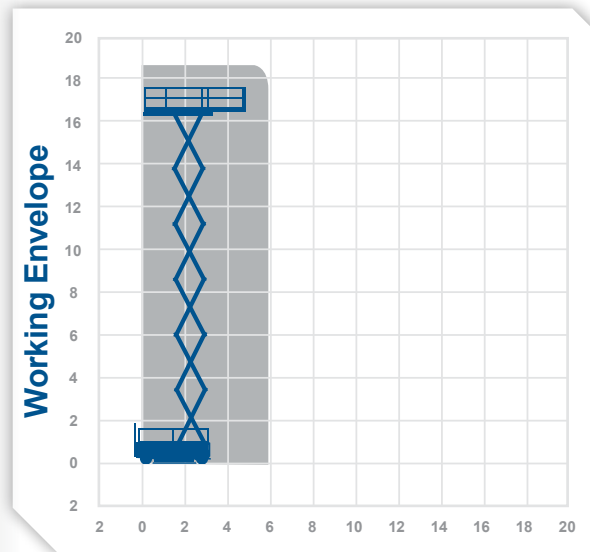

Nationwide Platforms
A Loxam Company





Working Height 21.4m

Closed Length	3.74m
Closed Height	3.74m
Stowed Height (guardrails lowered)	3.01m
Closed Width	1.20m
Platform Size	3.38m x 1.16m
Platform Length (deck extended)	4.88m
Max SWL	500kg
Weight	9120kg

Alternative machines

SL180N

Manufacturer

Holland Lift

Indoor use only



Working Envelope

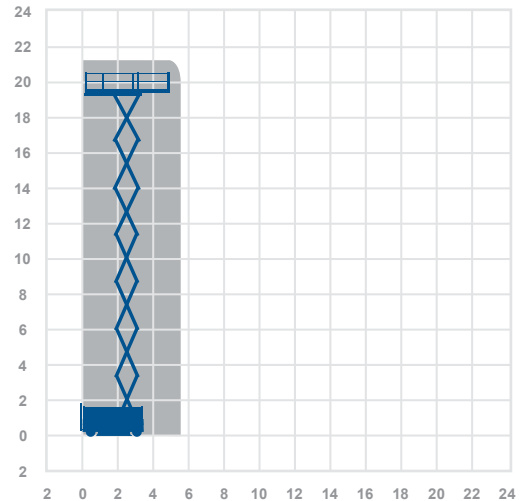

0345 745 0000
nationwideplatforms.co.uk



Nationwide Platforms
A **LOXAM** Company

HL220H

scissors

Working Height 21.7m

Closed Length	4.84m
Closed Height	3.65m
Stowed Height (guardrails lowered)	2.88m
Closed Width	2.44m
Platform Size	2.30m x 4.50m
Platform Length (deck extended)	7.0m
Max SWL	750kg
Weight	13900g

Alternative machines

HL220D
HL235D
S225
LL20X
SL210
SL245

Manufacturer

Holland Lift

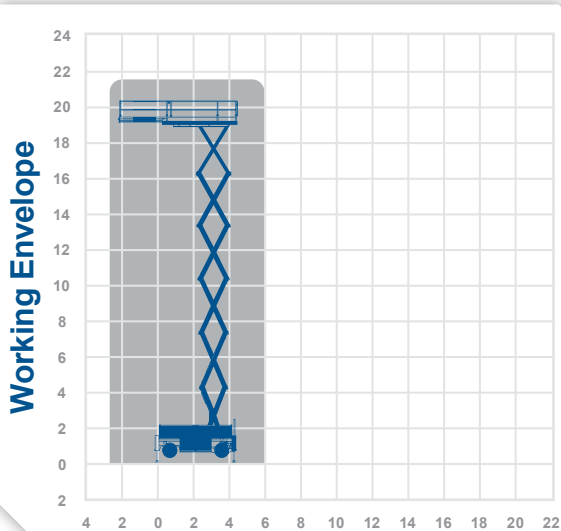

0345 745 0000
nationwideplatforms.co.uk

HL220D

scissors

Working Height 21.9m

Closed Length	4.84m
Closed Height	3.65m
Stowed Height (guardrails lowered)	2.88m
Closed Width	2.44m
Platform Size	4.50m X 2.30m
Platform Length (deck extended)	7.0m
Max SWL	750kg
Weight	12140kg

Alternative machines

LL20X
LL26X
HL235D
SL210

Manufacturer

Holland Lift

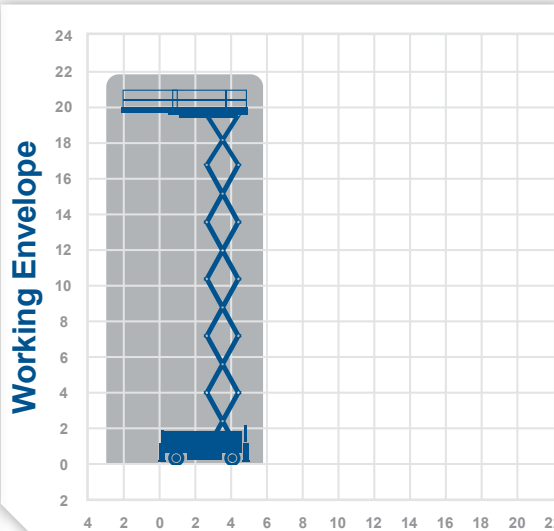

 Nationwide Platforms
A Loxam Company



S225-24

scissors

Working Height 22.5m

Closed Length	4.84m
Closed Height	3.72m
Stowed Height (guardrails lowered)	2.88m
Closed Width	2.39m
Platform Size	4.5m x 2.36m
Platform Length (deck extended)	7.2m
Max SWL	750kg
Weight	11000kg

Alternative machines

LL20X
LL26X
HL220D
HL235D

Manufacturer

HAB

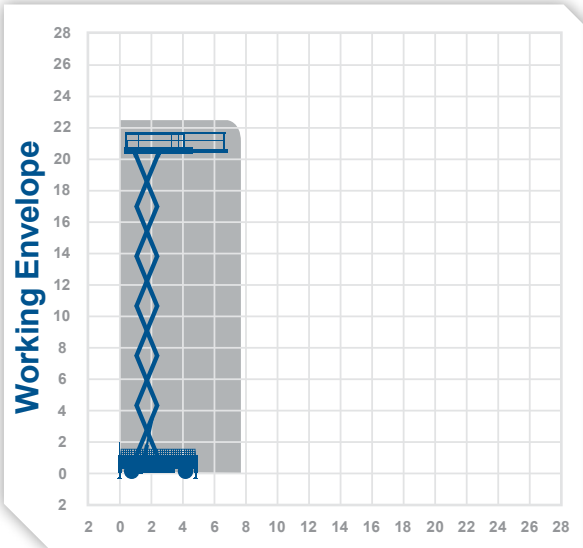

SL210

scissors

Working Height 23.0m

Closed Length	5.75m
Closed Height	4.1m
Stowed Height (guardrails lowered)	3.2m
Closed Width	2.5m
Platform Size	5.35m x 2.50m
Platform Length (deck extended)	7.55m
Max SWL	1000kg
Weight	15000kg

Alternative machines

LL20X
HL220D
HL235D
S225-24

Manufacturer

Liftlux

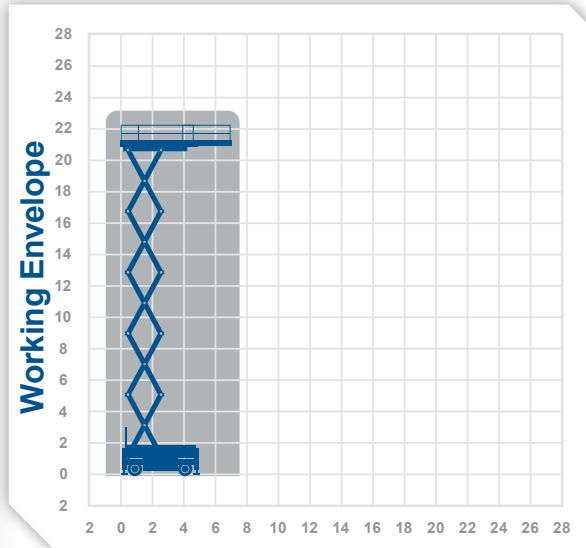

0345 745 0000
nationwideplatforms.co.uk



Nationwide Platforms
A Loxam Company

HL235D

scissors

Working Height 23.2m

Closed Length	5.75m
Closed Height	4.01m
Stowed Height (guardrails lowered)	3.1m
Closed Width	2.49m
Platform Size	5.22m x 2.40m
Platform Length (deck extended)	7.32m
Max SWL	1000kg
Weight	18100kg

Alternative machines

LL20X
S225-24
SL210
HL220D

Manufacturer

Holland Lift

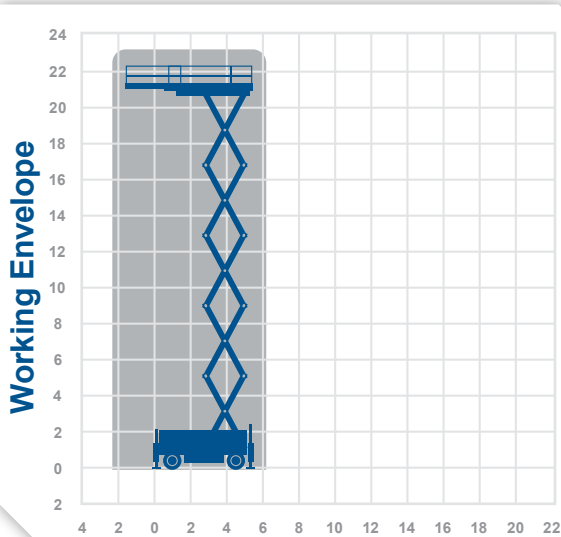

M250

scissors

Working Height 27.0m

Closed Length	6.57m
Closed Height	3.89m
Stowed Height (guardrails lowered)	3.13m
Closed Width	2.65m
Platform Size	6.15m x 2.5m
Platform Length (deck extended)	8.25m
Max SWL	1000kg
Weight	21910kg

Alternative machines

LL26X
SL245

Manufacturer

Holland Lift

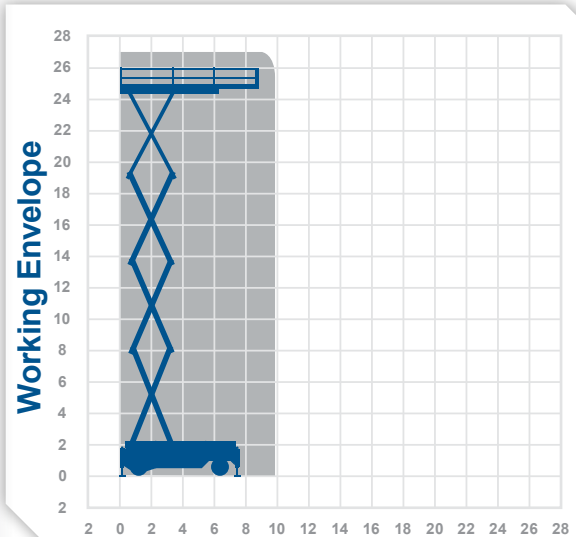

0345 745 0000
nationwideplatforms.co.uk



Nationwide Platforms
A **LOXAM** Company

HL275H

scissors

Working Height 27.2m

Closed Length	6.57m
Closed Height	3.89m
Stowed Height (guardrails lowered)	3.13m
Closed Width	2.5m
Platform Size	2.35m x 6.15m
Platform Length (deck extended)	8.25m
Max SWL	1000kg
Weight	25100kg

Alternative machines

M250
LL26X
S280

Manufacturer

Holland Lift

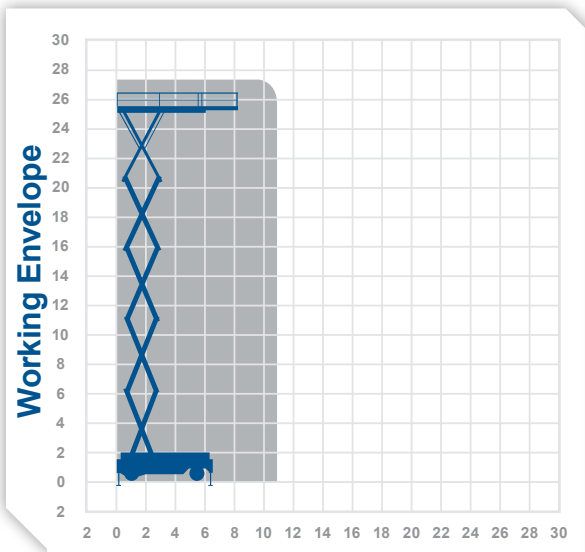

S280-25

scissors

Working Height 28.0m

Closed Length	5.96m
Closed Height	4.1m
Stowed Height (guardrails lowered)	3.4m
Closed Width	2.5m
Platform Size	5.48m x 2.44m
Platform Length (deck extended)	7.57m
Max SWL	750kg
Weight	18000kg

Alternative machines

LL26X

Manufacturer

HAB

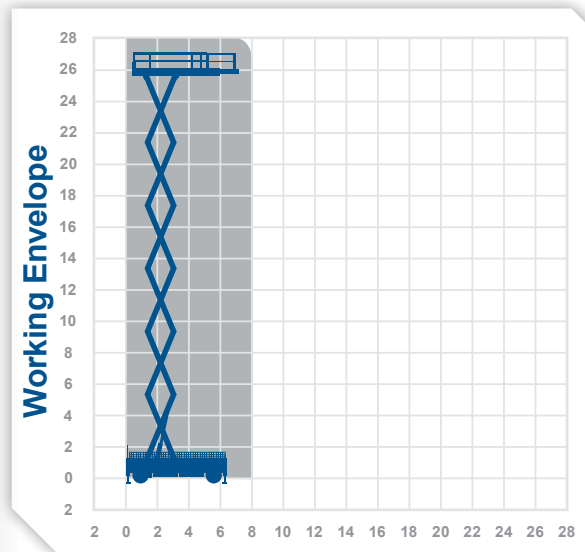

0345 745 0000
nationwideplatforms.co.uk



Nationwide Platforms
A **LOXAM** Company

LL26X

scissors

Working Height 28.3m

Closed Length	7.15m
Closed Height	4.2m
Stowed Height (guardrails lowered)	3.1m
Closed Width	2.5m
Platform Size	6.7m x 2.5m
Platform Length (deck extended)	9.8m
Max SWL	1000kg
Weight	25000kg

Alternative machines

M250
SL245
S280-25

Manufacturer

Liftlux

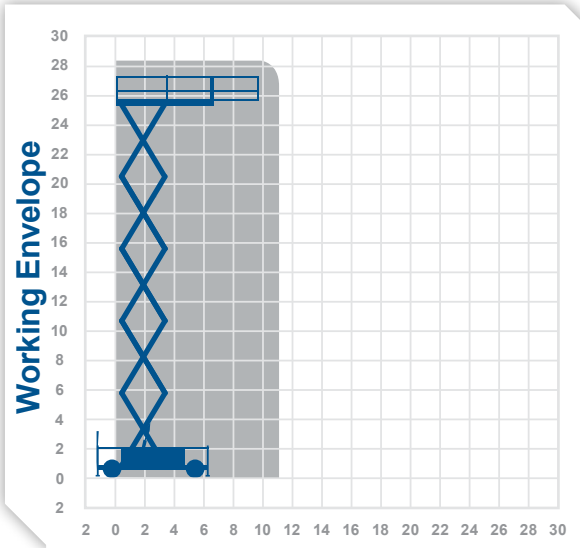

HL340D

scissors

Working Height 33.5m

Closed Length	7.02m
Closed Height	3.63m
Stowed Height (guardrails lowered)	2.87m
Closed Width	2.98m
Platform Size	6.66m x 2.80m
Platform Length (deck extended)	9.66m
Max SWL	1000kg
Weight	31350kg

Alternative machines

S280-25
LL26X

Manufacturer

Holland Lift

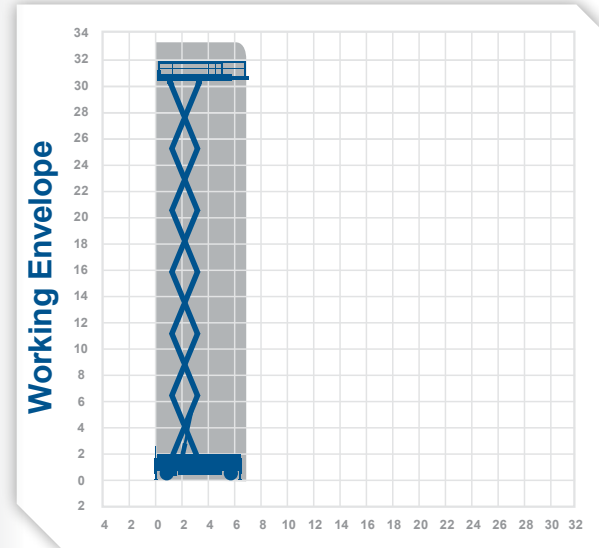

0345 745 0000
nationwideplatforms.co.uk



Nationwide Platforms
A **LOXAM** Company

28.3m

33.5m

Boom Lifts



- More than 6,100 units available to hire across the UK
- Working heights from 10m to 56m
- Variety of power options
- Narrow aisle machines
- Telescopic or articulating action
- Rough terrain tyre option
- Non-marking tyres for use on finished floors

Machine type by product code

Star10	Z45BJ	Z80
Star10A	Z45EJ	HA260PX
Z30N	HA16PX	80JX
G30N	HA16RTJ	G85X
30JP	Z4525DJX	S85
HA12CJ	SJ46AJ	HR28H
Z33E	HR17H	860SJ
HR12NBS	TITAN60	HA32PX
G34N	Z60FE	1200SJP
G34DX	60AJX	1250AJP
40NJ	G60X	S125
HA15IP	HA20RTJPRO	HA41RTJPRO
HR15NBS	HA20PX	Z135
HR15NH	HR21H	ZX135
Z45DJX	HR21D	SX135HC
45MJ	Z62	1350SJP
S45X	S65X	SX150
45JSX	66JX	1500AJP
Z45DJXC	HT23RTJ	SX180

0345 745 0000
nationwideplatforms.co.uk



Nationwide Platforms
 A **LOXAM** Company

Star10

booms

Working Height 10.0m
Horizontal Outreach 3.0m

Closed Length 2.62m
Closed Height 1.99m
Closed Width 1.0m
Platform Size 0.9m x 0.7m
Rotation 360°
Max SWL 200kg
Weight 2760kg

Alternative machines

Star10 A

Manufacturer

Haulotte

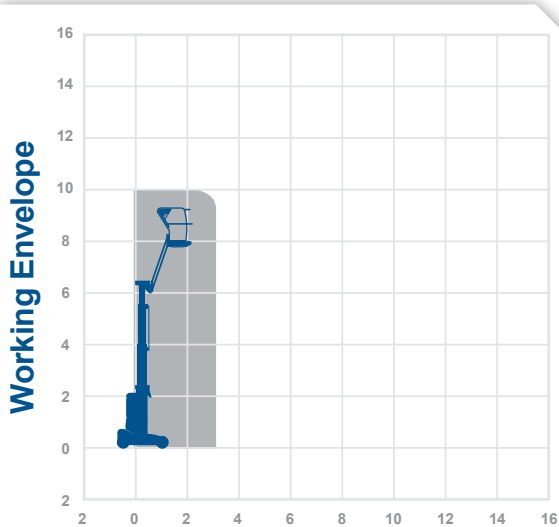

Star10 A

booms

Working Height 10.0m
Horizontal Outreach 3.0m

Closed Length 2.7m
Closed Height 1.99m
Closed Width 1.0m
Platform Size 0.98m x 0.78m
Rotation 345°
Max SWL 200kg
Weight 2677kg

Alternative machines

Star10

Manufacturer

Haulotte

fitted with manufacturers secondary guarding as standard

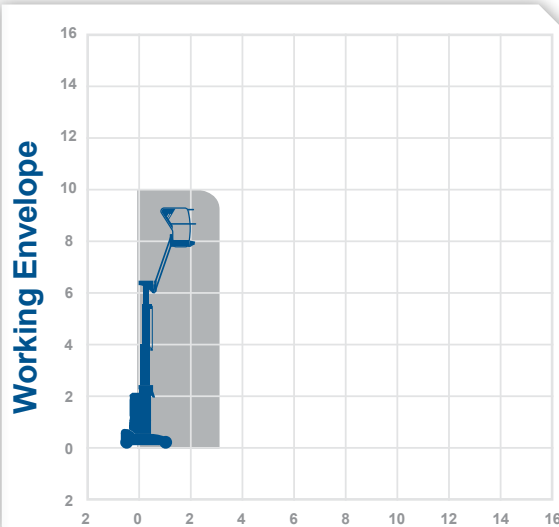

0345 745 0000
nationwideplatforms.co.uk



Nationwide Platforms
A **LOXAM** Company



Working Height **10.89m** Horizontal Outreach **6.25m**

Closed Length	5.31m
Closed Height	2.0m
Closed Width	1.19m
Platform Size	1.17m x 0.76m
Rotation	355°
Max SWL	227kg
Weight	6450kg

Alternative machines

30JP
30J
40NJ
G30N

Manufacturer

Genie

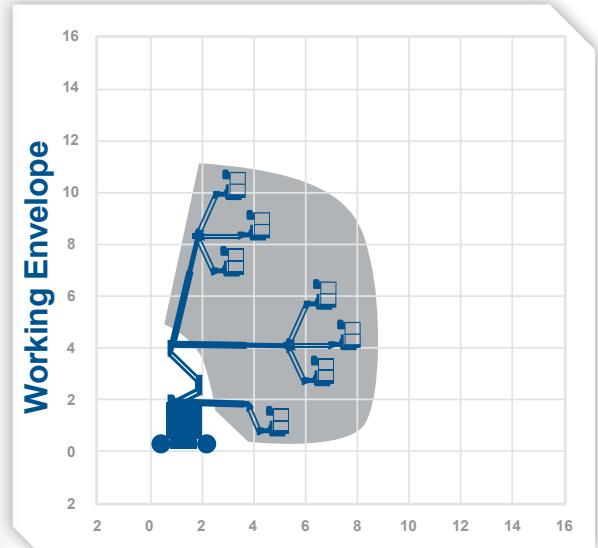

0345 745 0000
nationwideplatforms.co.uk



Nationwide Platforms
A **LOXAM** Company

6.25m 10.89m

Working Height 11.0m Horizontal Outreach 6.4m

Closed Length	5.2m
Closed Height	2.0m
Closed Width	1.2m
Platform Size	1.17m x 0.76m
Rotation	355°
Max SWL	227kg
Weight	6577kg

Alternative machines

30JP
Z30N

Manufacturer

Genie

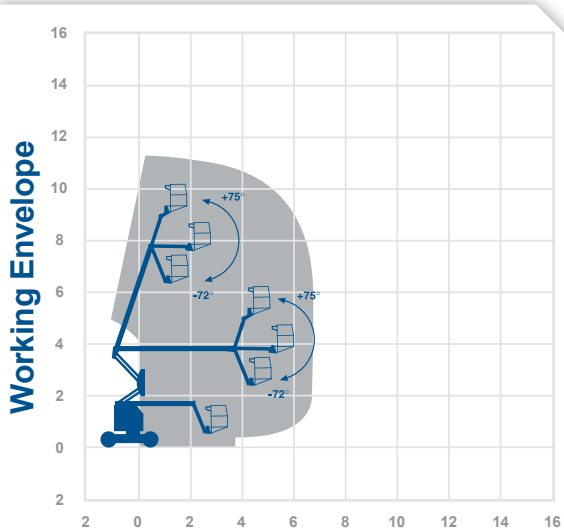

Working Height 11.14m Horizontal Outreach 6.25m

Closed Length	5.59m
Closed Height	2.0m
Closed Width	1.22m
Platform Size	1.22m x 0.76m
Rotation	140°
Max SWL	227kg
Weight	6849kg

Alternative machines

G30N
Z30N
30J

Manufacturer

JLG

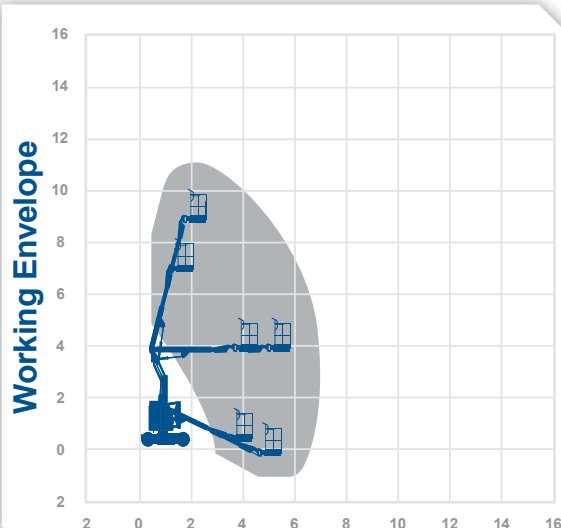

0345 745 0000
nationwideplatforms.co.uk



Nationwide Platforms
A **LOXAM** Company

Working Height 11.68m
Horizontal Outreach 6.94m

Closed Length	5.36m
Closed Height	1.99m
Closed Width	1.2m
Platform Size	1.14m x 0.80m
Rotation	355°
Max SWL	250kg
Weight	7065kg

Alternative machines

G30N
Z30N
30JP

Manufacturer

Haulotte

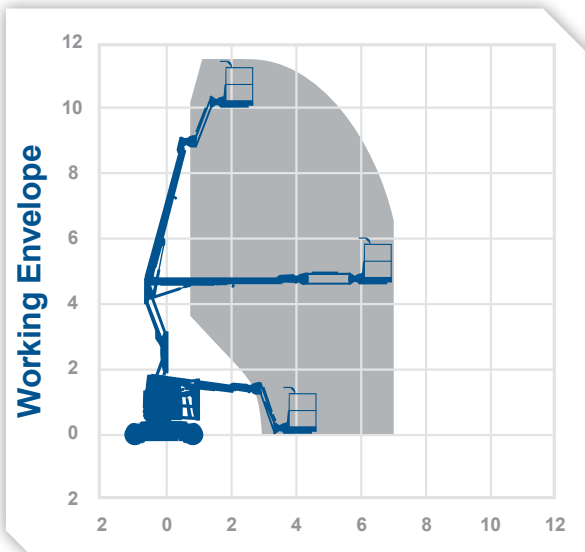

0345 745 0000
nationwideplatforms.co.uk

Working Height 12.0m
Horizontal Outreach 5.57m

Closed Length	4.17m
Closed Height	1.98m
Closed Width	1.5m
Platform Size	1.16m x 0.76m
Rotation	400°
Max SWL	200kg
Weight	3665kg

Alternative machines

HR12NB
HR12NBS

Manufacturer

Genie

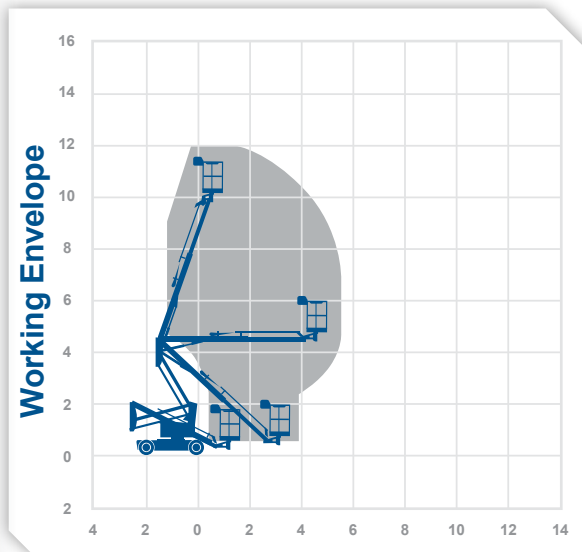

Nationwide Platforms
 A **LOXAM** Company



Working Height 12.2m
Horizontal Outreach 6.1m

Closed Length 4.1m
 Closed Height 1.9m
 Closed Width 1.5m
 Platform Size 1.10m x 0.65m
 Rotation 360°
 Max SWL 200kg
 Weight 3435kg

Alternative machines

40NJ
 HR15NB
 HR12NB

Manufacturer

Niftylift

fitted with manufacturers secondary guarding as standard

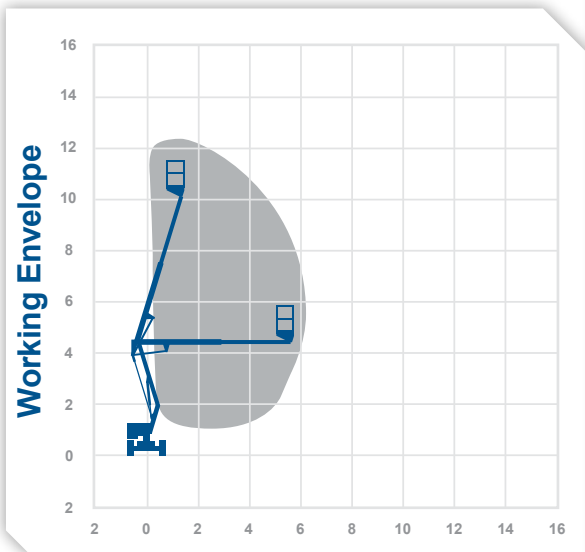

Working Height 12.52m
Horizontal Outreach 6.78m

Closed Length 5.72m
 Closed Height 2.0m
 Closed Width 1.47m
 Platform Size 1.42m x 0.76m
 Rotation 355°
 Max SWL 227kg
 Weight 5171kg

Alternative machines

HR12NB
 Z33
 G34E
 HR12NB

Manufacturer

Genie

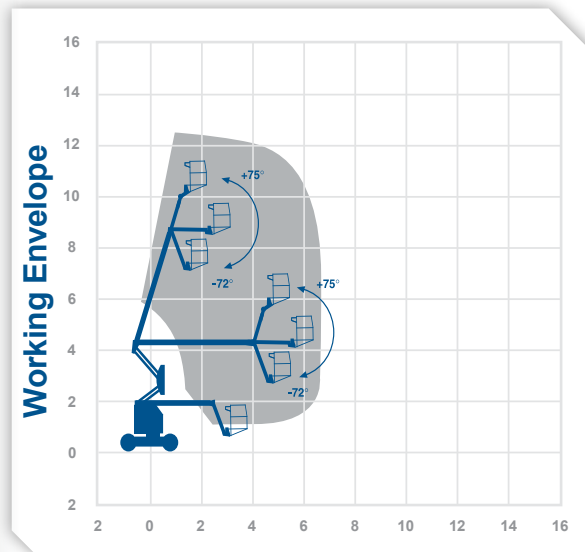

0345 745 0000
 nationwideplatforms.co.uk



Nationwide Platforms
 A Loxam Company

G34DX

booms

Working Height 12.62m

Horizontal Outreach 6.78m

Closed Length	5.66m
Closed Height	2.06m
Closed Width	1.85m
Platform Size	1.42m x 0.76m
Rotation	355°
Max SWL	227kg
Weight	4929kg

Alternative machines

G34D

Manufacturer

Genie

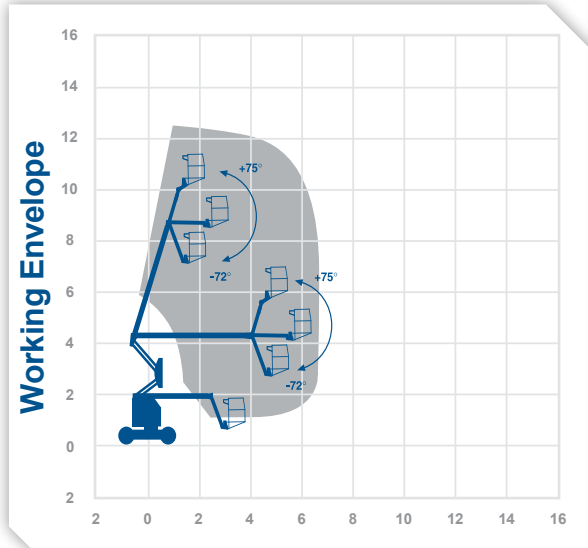

40NJ

booms

Working Height 14.19m

Horizontal Outreach 6.83m

Closed Length	6.71m
Closed Height	1.97m
Closed Width	1.5m
Platform Size	1.22m x 0.76m
Rotation	360°
Max SWL	230kg
Weight	6759kg

Alternative machines

HR15NB
Z45BJ

Manufacturer

JLG

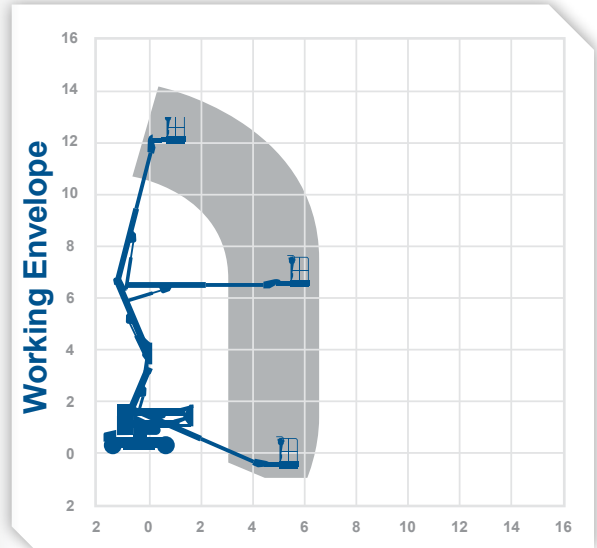

0345 745 0000
nationwideplatforms.co.uk



Nationwide Platforms
 A **LOXAM** Company

HA15IP

booms

Working Height 14.87m
Horizontal Outreach 8.65m

Closed Length 6.65m
Closed Height 2.1m
Closed Width 1.52m
Platform Size 1.15m x 0.80m
Rotation 355°
Max SWL 230kg
Weight 7230kg

Alternative machines

HR15NBS
HR15NH

Manufacturer

Haulotte

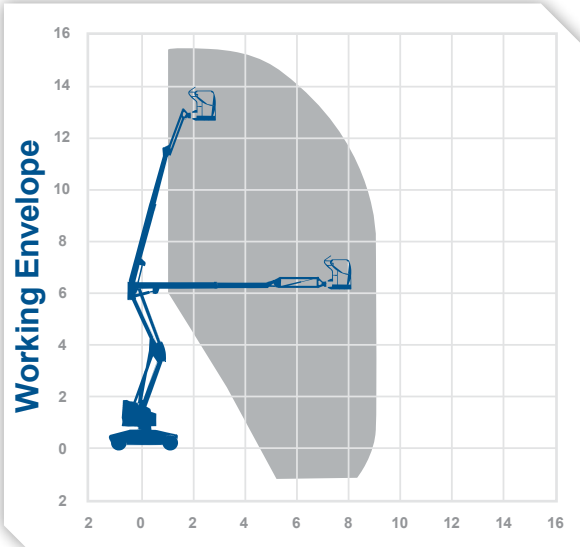

HR15NBS

booms

Working Height 15.4m
Horizontal Outreach 9.6m

Closed Length 6.3m
Closed Height 2.1m
Closed Width 1.5m
Platform Size 1.5m x 0.7m
Rotation 360°
Max SWL 225kg
Weight 6680kg

Alternative machines

40NJ
Z45BJ
HR15NB

Manufacturer

Niftylift

fitted with manufacturers secondary guarding as standard

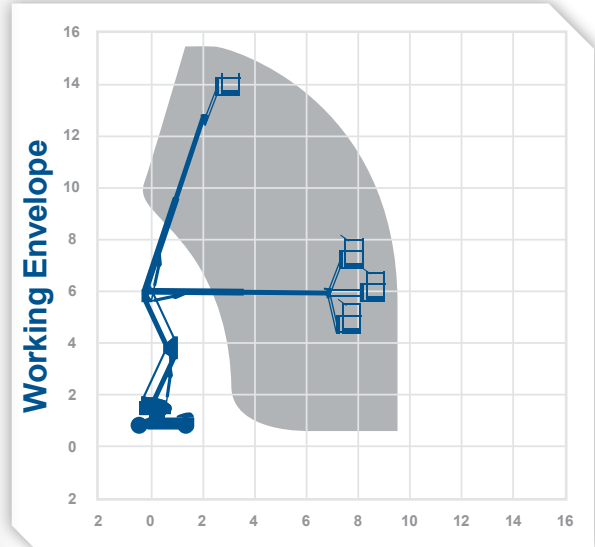

0345 745 0000
nationwideplatforms.co.uk



Nationwide Platforms
A Loxam Company

HR15NH

booms

Working Height 15.5m
Horizontal Outreach 9.7m

Closed Length 6.4m
Closed Height 1.99m
Closed Width 1.5m
Platform Size 1.5m x 0.8m
Rotation 360°
Max SWL 225kg
Weight 7250kg

Alternative machines

HR15NBS

Manufacturer

Niftylift

fitted with manufacturers secondary guarding as standard

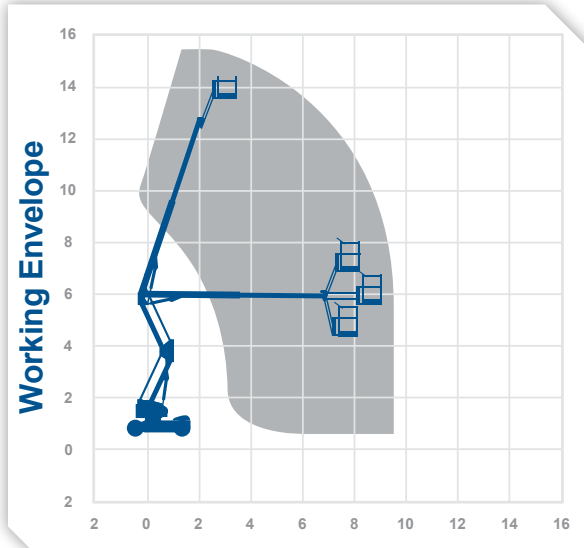

0345 745 0000
nationwideplatforms.co.uk

Z45DJX

booms

Working Height 15.69m
Horizontal Outreach 7.6m

Closed Length 6.78m
Closed Height 2.08m
Closed Width 2.23m
Platform Size 1.82m x 0.76m
Rotation 359°
Max SWL 227kg
Weight 6542kg (Air)
6892kg (Foam Filled)

Alternative machines

Z45D
Z45D-R
Z4525DJX

Manufacturer

Genie

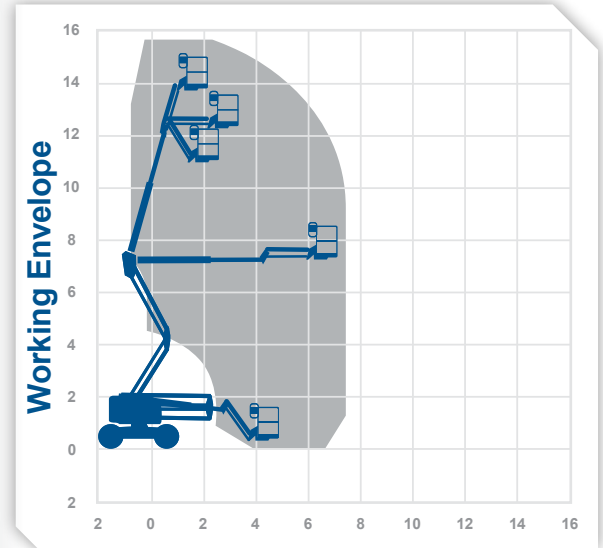

Nationwide Platforms
A Loxam Company



45MJ

booms

Working Height 15.72m
Horizontal Outreach 7.24m

Closed Length 6.5m
Closed Height 2.01m
Closed Width 1.75m
Platform Size 1.52m x 0.76m
Rotation 360°
Max SWL 230kg
Weight 6532kg

Alternative machines

HR15NBS
Z45BJ
45MJP

Manufacturer

JLG

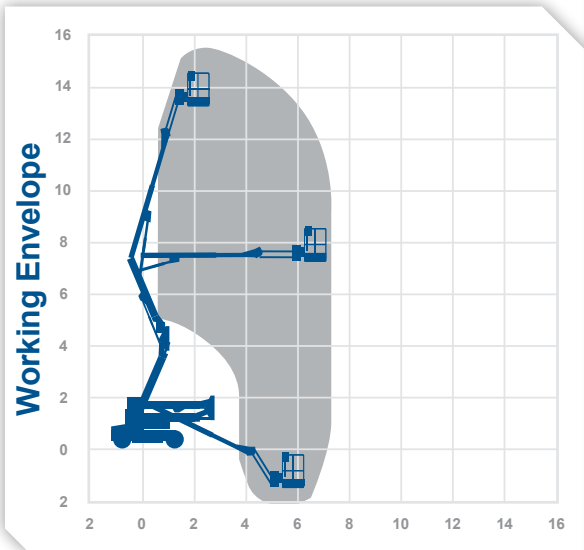

S45X

booms

Working Height 15.72m
Horizontal Outreach 11.18m

Closed Length 8.48m
Closed Height 2.49m
Closed Width 2.3m
Platform Size 1.83m x 0.76m
Rotation Continuous
Max SWL 227kg
Weight 6709kg
Reach Below Ground 1.5m

Manufacturer

Genie

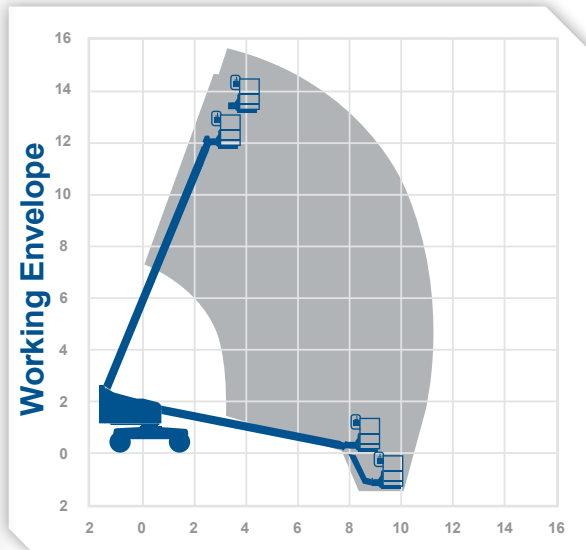

0345 745 0000
nationwideplatforms.co.uk



Nationwide Platforms
A Loxam Company

Working Height 15.72m

Horizontal Outreach 7.47m

Closed Length	6.58m
Closed Height	2.27m
Closed Width	2.35m
Platform Size	1.83m x 0.76m
Rotation	355°
Max SWL	230kg
Weight	7484kg

Alternative machines

HA16SPX
Z45DJXC

Manufacturer

JLG

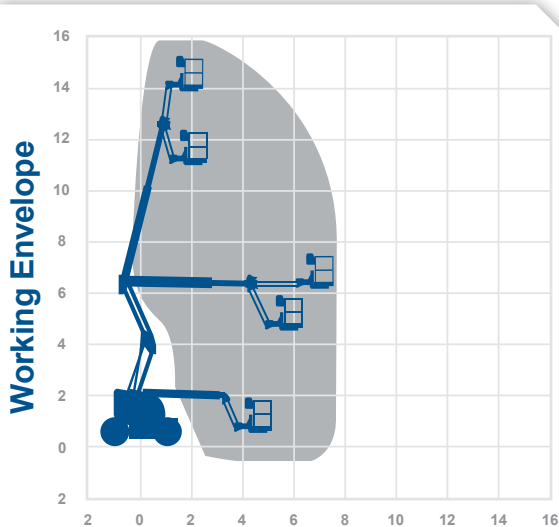

0345 745 0000
nationwideplatforms.co.uk

Working Height 15.86m

Horizontal Outreach 7.55m

Closed Length	6.66m
Closed Height	2.25m
Closed Width	2.29m
Platform Size	1.83m x 0.76m
Rotation	355°
Max SWL	454kg
Weight	6984kg

Alternative machines

Z45DJXC
45JSX
HA16SPX

Manufacturer

Genie

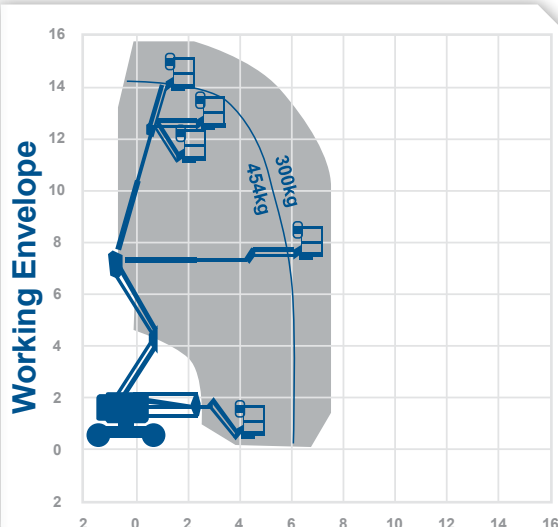

Nationwide Platforms
A Loxam Company



Z45BJ

booms

Working Height 15.94m
Horizontal Outreach 7.65m

Closed Length 6.83m
 Closed Height 2.0m
 Closed Width 1.79m
 Platform Size 1.83m x 0.76m
 Rotation 355°
 Max SWL 227kg
 Weight 7620kg

Alternative machines

Z45EJ

Manufacturer

Genie

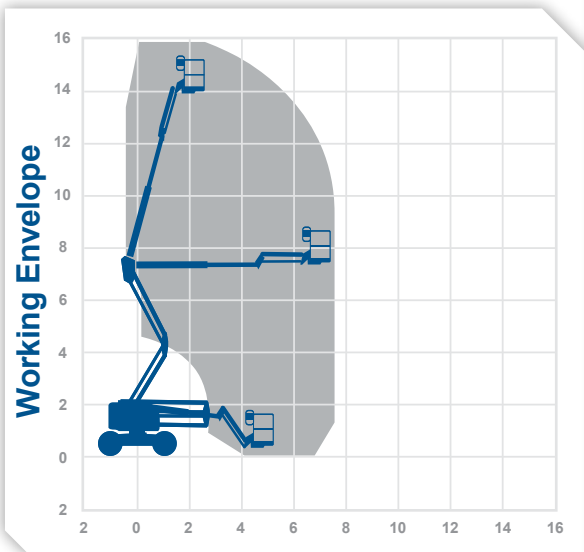

0345 745 0000
nationwideplatforms.co.uk

Z45EJ

booms

Working Height 15.94m
Horizontal Outreach 7.65m

Closed Length 6.83m
 Closed Height 2.0m
 Closed Width 1.79m
 Platform Size 1.83m x 0.76m
 Rotation 355°
 Max SWL 227kg
 Weight 7394kg

Alternative machines

45EJ
Z45E
45EJ

Manufacturer

Genie

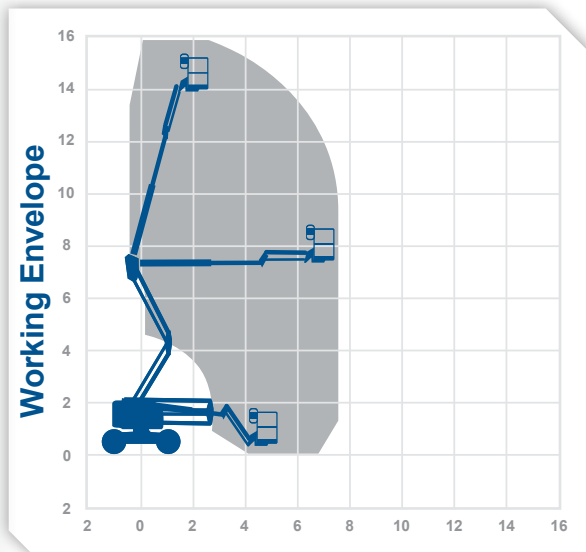

Nationwide Platforms
 A **LOXAM** Company



HA16PX

booms

Working Height 16.0m

Horizontal Outreach 9.15m

Closed Length 6.95m
 Closed Height 2.3m
 Closed Width 2.3m
 Platform Size 1.8m x 0.8m
 Rotation 360°
 Max SWL 230kg
 Weight 6950kg

Alternative machines

Z4525DJX
45JSX
SJ46AJ

Manufacturer

Haulotte

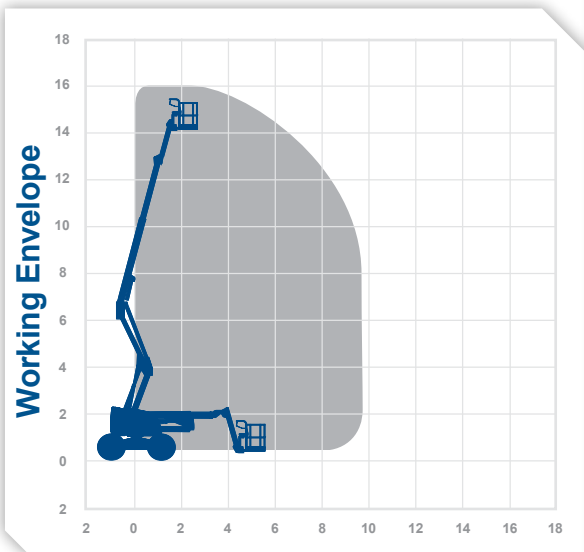

0345 745 0000
nationwideplatforms.co.uk

HA16RTJ

booms

Working Height 16.0m

Horizontal Outreach 8.3m

Closed Length 6.75m
 Closed Height 2.3m
 Closed Width 2.3m
 Platform Size 1.83m x 0.8m
 Rotation 355°
 Max SWL 230kg
 Weight 6200kg

Alternative machines

Z4525DJX
45JSX
SJ46AJ

Manufacturer

Haulotte

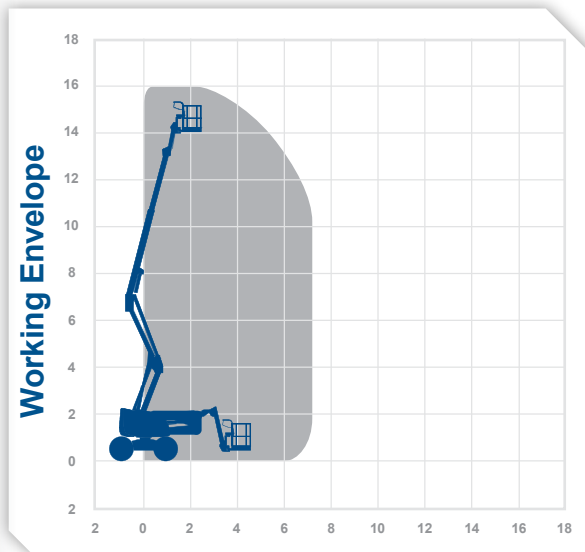

Nationwide Platforms
 A **LOXAM** Company



Z4525DJX

booms

Working Height 16.05m
Horizontal Outreach 7.52m

Closed Length 6.65m
Closed Height 2.13m
Closed Width 2.29m
Platform Size 1.83m x 0.76m
Rotation 355°
Max SWL 227kg
Weight 6574kg

Alternative machines

Z45DJX
45JSX

Manufacturer

Genie

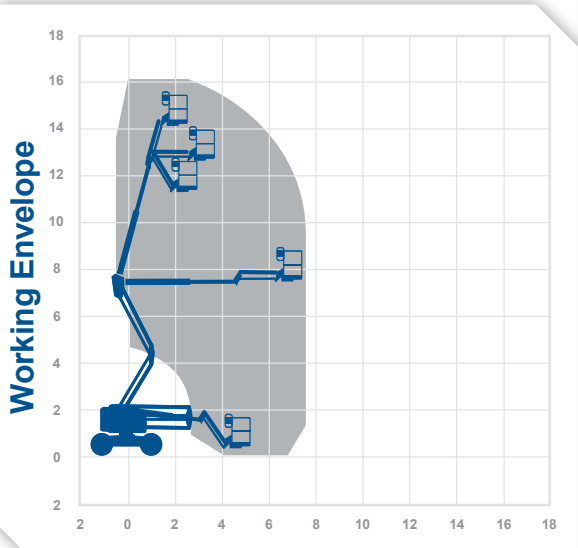

0345 745 0000
nationwideplatforms.co.uk

SJ46AJ

booms

Working Height 16.1m
Horizontal Outreach 7.54m

Closed Length 6.5m
Closed Height 2.07m
Closed Width 2.29m
Platform Size 1.83m x 0.76m
Rotation 360°
Max SWL 227kg
Weight 6500kg

Alternative machines

Z4525DJX
Z45DJX
45JSX
160ATJ

Manufacturer

Skyjack

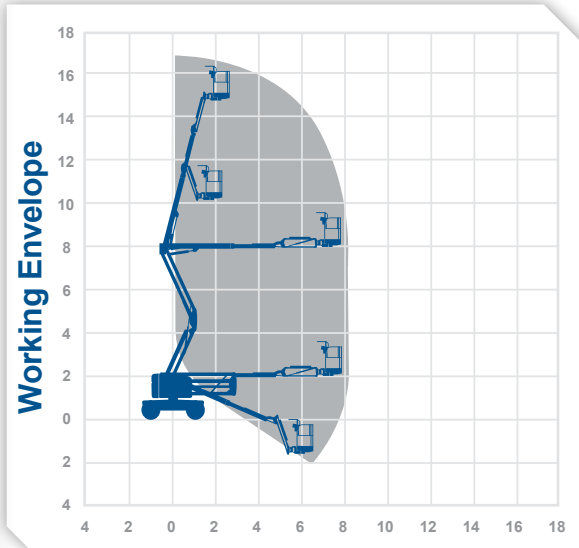

Nationwide Platforms
A **LOXAM** Company



HR17H

booms

Working Height 17.2m
Horizontal Outreach 9.4m

Closed Length	6.35m
Closed Height	2.1m
Closed Width	2.0m
Platform Size	1.8m x 0.85m
Rotation	360°
Max SWL	225kg
Weight	5000kg

Alternative machines

HR21H

Manufacturer

Niftylift

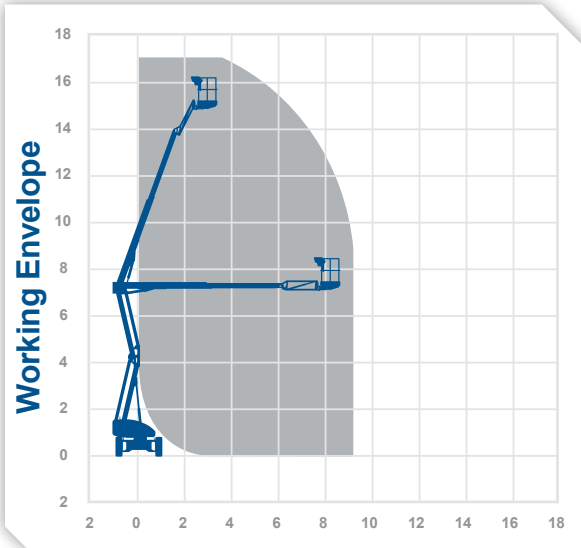

0345 745 0000
nationwideplatforms.co.uk



TITAN60

booms

Working Height 20.0m
Horizontal Outreach 14.6m

Closed Length	7.0m
Closed Height	3.4m
Closed Width	2.6m
Width (stabilisers down)	3.7m
Platform Size	6.7m x 2.28m
Rotation	180°
Max SWL	1350kg
Weight	18000kg

Alternative machines

TITAN40

Manufacturer

MEC

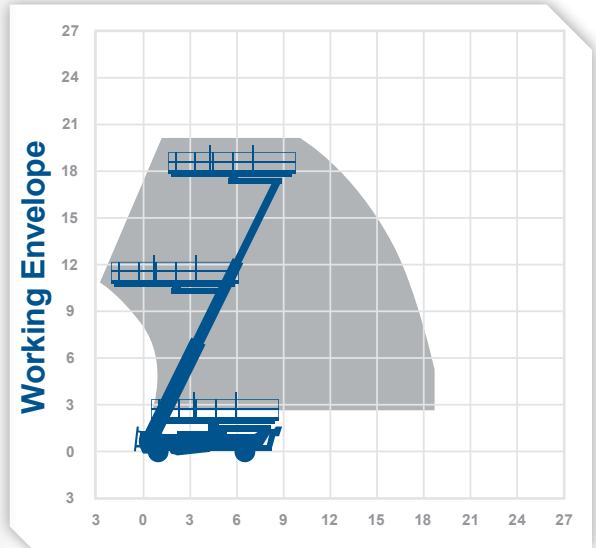

Nationwide Platforms
A **LOXAM** Company

Z60FE

booms

Working Height 20.16m
Horizontal Outreach 11.15m

Closed Length 8.15m
 Closed Height 2.54m
 Closed Width 2.49m
 Platform Size 1.83m x 0.76m
 Rotation 355°
 Max SWL 227kg
 Weight 7756kg

Alternative machines

HR21H

Manufacturer

Genie

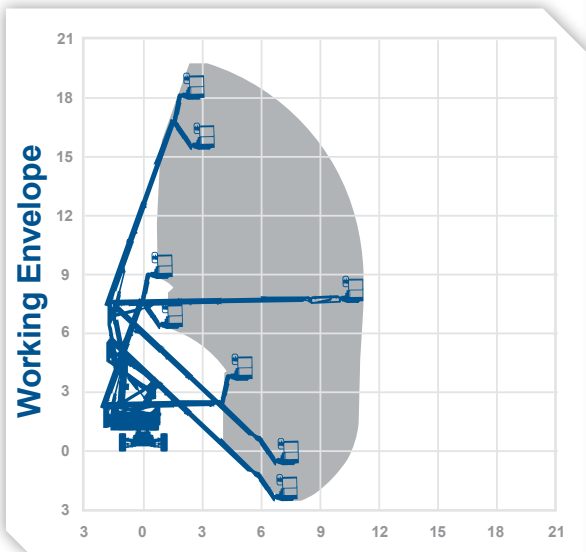

60AJX

booms

Working Height 20.29m
Horizontal Outreach 12.12m

Closed Length 8.82m
 Closed Height 2.56m
 Closed Width 2.44m
 Platform Size 1.83m x 0.91m
 Rotation 180°
 Max SWL 227kg
 Weight 10650kg

Alternative machines

Z62
 G60X
 HR21D
 60AJ
 60AJX-P

Manufacturer

JLG

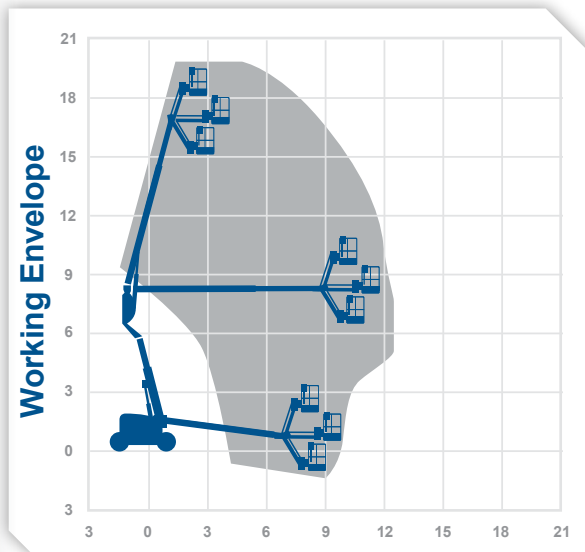

0345 745 0000
 nationwideplatforms.co.uk



Nationwide Platforms
 A Loxam Company

Working Height **20.39m** Horizontal Outreach **11.05m**

Closed Length	8.15m
Closed Height	2.69m
Closed Width	2.46m
Platform Size	1.83m x 0.76m
Rotation	Continuous
Max SWL	227kg
Weight	10,025kg (Air) 10,765kg (Foam Filled)

Alternative machines

G60-R
HR21D
60HJX
Z62

Manufacturer

Genie

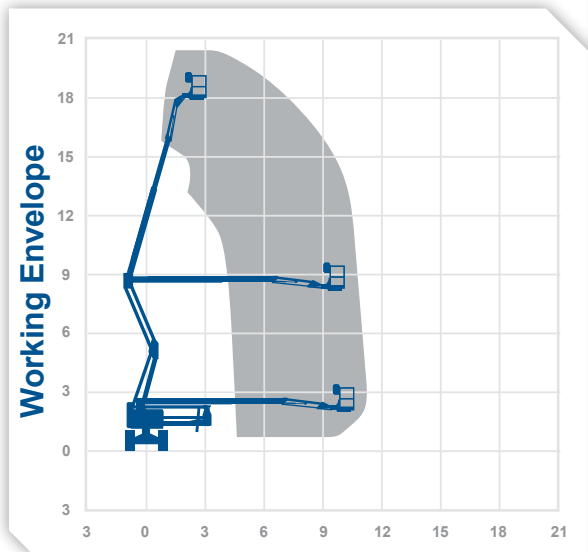

Working Height **20.6m** Horizontal Outreach **12.2m**

Closed Length	8.8m
Closed Height	2.51m
Closed Width	2.42m
Platform Size	1.83m x 0.80m
Rotation	Continuous
Max SWL	230kg
Weight	9600kg

Alternative machines

G60X
HA260PX
HR21D

Manufacturer

Haulotte

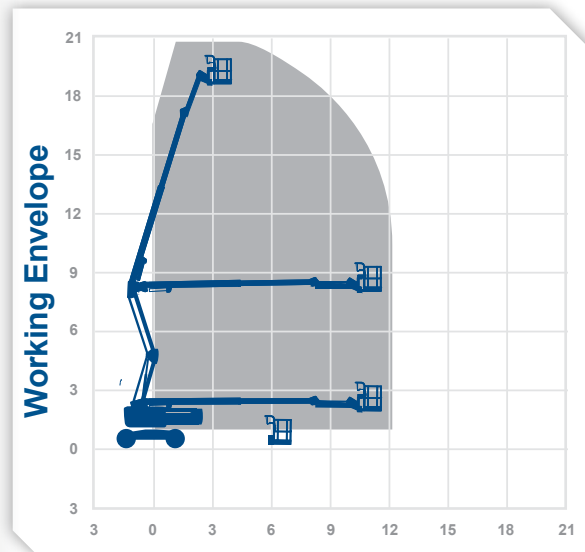

0345 745 0000
nationwideplatforms.co.uk



Nationwide Platforms
A **LOXAM** Company

Working Height 20.65m
Horizontal Outreach 13.5m

Closed Length 8.93m
 Closed Height 2.67m
 Closed Width 2.38m
 Platform Size 1.8m x 0.8m
 Rotation 360°
 Max SWL 230kg
 Weight 11710kg

Alternative machines

G60X

Manufacturer

Haulotte

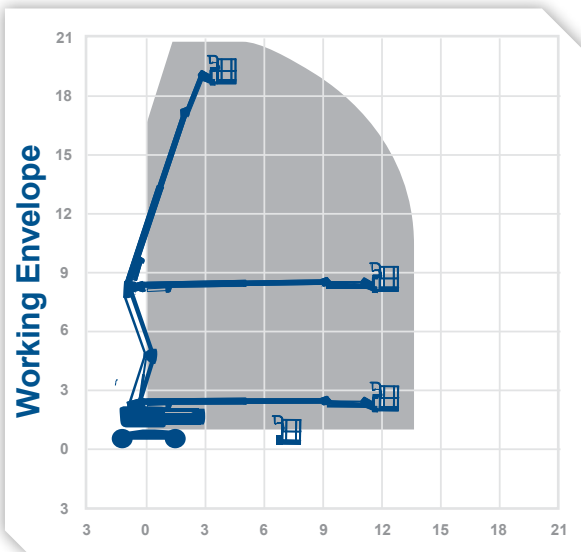

0345 745 0000
nationwideplatforms.co.uk



Nationwide Platforms
 A **LOXAM** Company

HR21H

booms

Working Height 20.8m

Horizontal Outreach 12.5m

Closed Length 5.3m
 Closed Height 2.15m
 Closed Width 2.27m
 Platform Size 1.80m x 0.85m
 Rotation 360°
 Max SWL 225kg
 Weight 6500kg

Alternative machines

M60J
HR21B

Manufacturer

Niftylift

fitted with manufacturers secondary guarding as standard

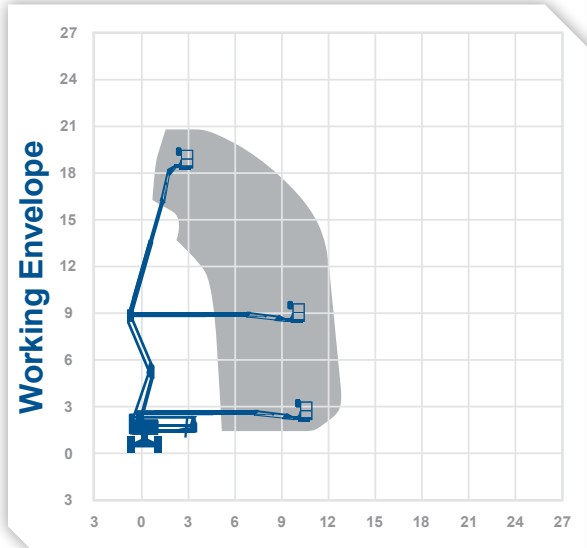

HR21D

booms

Working Height 20.8m

Horizontal Outreach 12.5m

Closed Length 5.3m
 Closed Height 2.15m
 Closed Width 2.27m
 Platform Size 1.8m x 0.85m
 Rotation 360°
 Max SWL 225kg
 Weight 6220kg

Alternative machines

HA20PX
G60X

Manufacturer

Niftylift

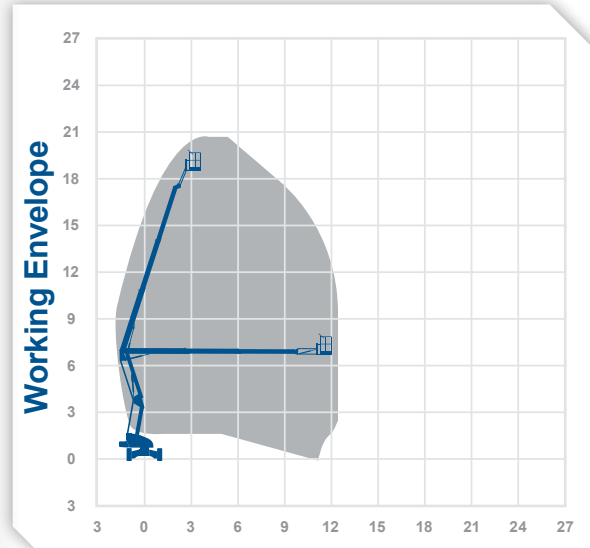

0345 745 0000
nationwideplatforms.co.uk



Nationwide Platforms
 A **LOXAM** Company

Working Height 20.87m

Horizontal Outreach 12.47m

Closed Length	9.25m
Closed Height	2.4m
Closed Width	2.49m
Platform Size	1.83m x 0.76m
Rotation	Continuous
Max SWL	227kg
Weight	10766kg

Alternative machines

G60X
60AJX

Manufacturer

Genie

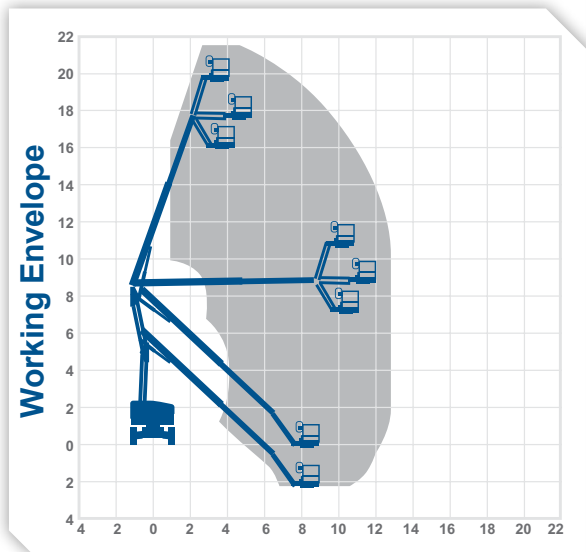

0345 745 0000
nationwideplatforms.co.uk



Working Height 21.8m

Horizontal Outreach 17.1m

Closed Length	9.5m
Closed Height	2.72m
Closed Width	2.5m
Platform Size	1.83m x 0.76m
Rotation	Continuous
Max SWL	227kg
Weight	10102kg
Reach Below Ground	2.71m

Alternative machines

G65X
66JX

Manufacturer

Genie

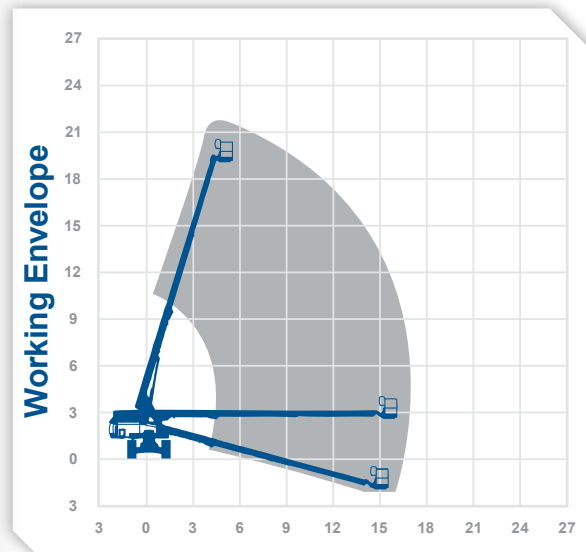

 **Nationwide Platforms**
A **LOXAM** Company

Working Height 22.12m
Horizontal Outreach 17.3m

Closed Length 10.21m
 Closed Height 2.56m
 Closed Width 2.43m
 Platform Size 1.83m x 0.91m
 Rotation 180°
 Max SWL 227kg
 Weight 13500kg

Alternative machines

S65X
 G65
 G65X

Manufacturer

JLG

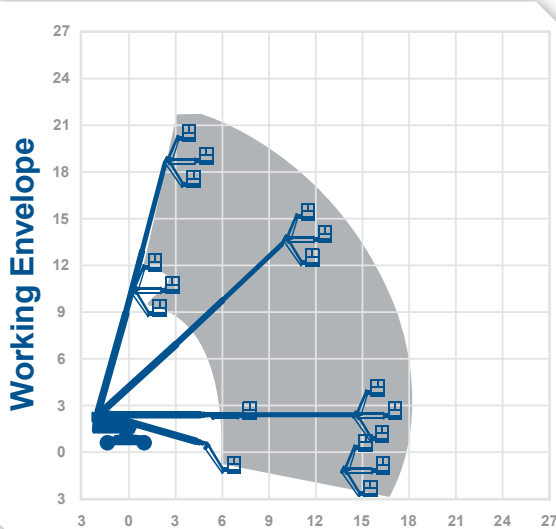

0345 745 0000
nationwideplatforms.co.uk



Working Height 22.5m
Horizontal Outreach 18.3m

Closed Length 10.4m
 Closed Height 2.7m
 Closed Width 2.47m
 Platform Size 2.44m x 0.91m
 Rotation Continuous
 Max SWL 230kg
 Weight 13400kg
 Reach Below Ground 4.0m

Alternative machines

S65X
 66JX

Manufacturer

Haulotte

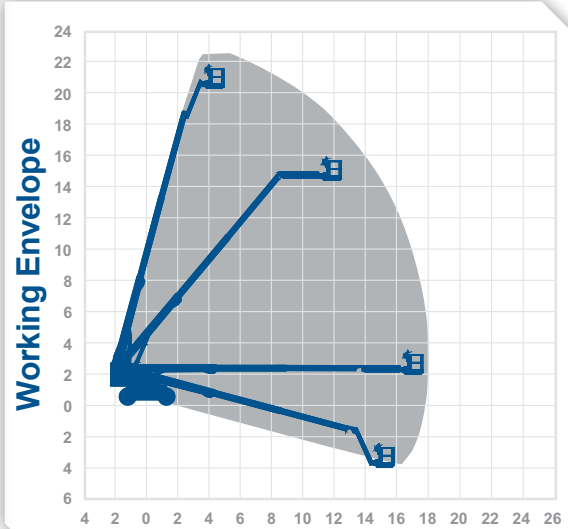

Nationwide Platforms
 A **LOXAM** Company

Working Height 25.6m Horizontal Outreach 18.29m

Closed Length	11.27m
Closed Height	3.0m
Closed Width	2.49m
Platform Size	2.44m x 0.91m
Rotation	Continuous
Max SWL	227kg
Weight	17010kg

Alternative machines

80JX

Manufacturer

Genie

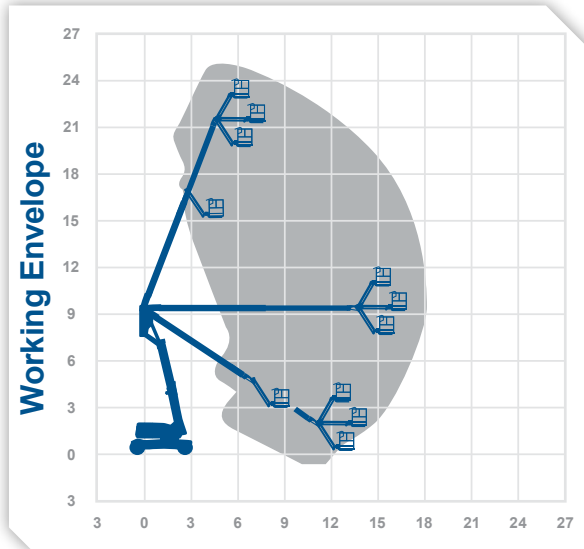

0345 745 0000
nationwideplatforms.co.uk



Working Height 25.6m Horizontal Outreach 16.2m

Closed Length	12.0m
Closed Height	2.71m
Closed Width	2.4m
Platform Size	1.8m x 0.8m
Rotation	360°
Max SWL	230kg
Weight	15890kg

Alternative machines

80JX
Z80

Manufacturer

Haulotte

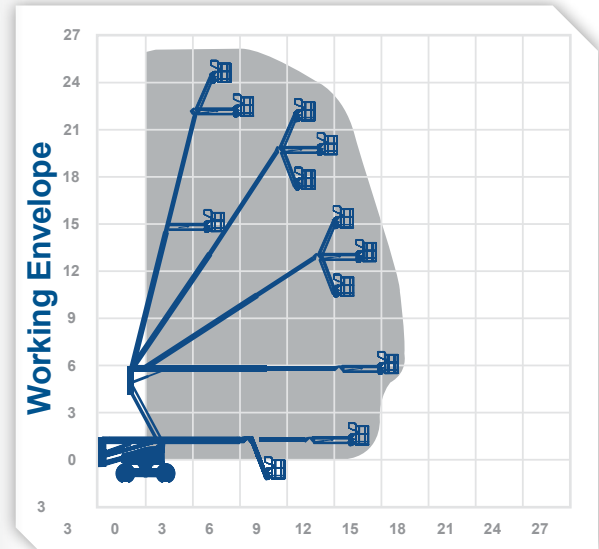

Nationwide Platforms
A Loxam Company

Working Height 26.38m

Horizontal Outreach 15.74m

Closed Length	11.12m
Closed Height	3.0m
Closed Width	2.44m
Platform Size	1.83m x 0.91m
Rotation	360°
Max SWL	230kg
Weight	15600kg

Alternative machines

Z80

Manufacturer

JLG

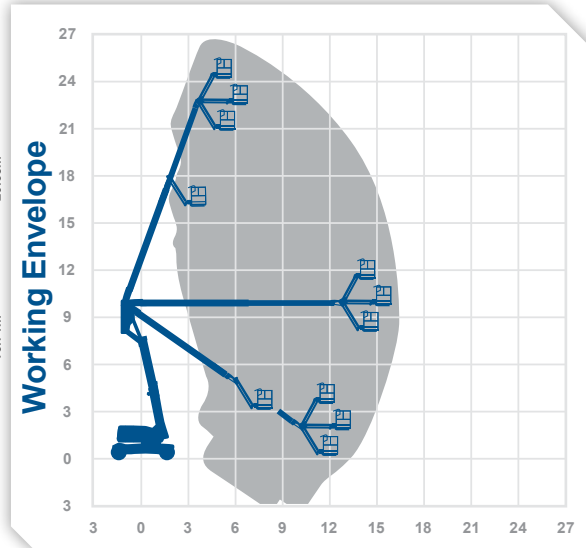

0345 745 0000
nationwideplatforms.co.uk



Nationwide Platforms
 A **LOXAM** Company

Working Height 27.7m
Horizontal Outreach 23.4m

Closed Length	12.4m
Closed Height	2.8m
Closed Width	2.4m
Platform Size	1.8m x 0.76m
Rotation	Continuous
Max SWL	227kg
Weight	16500kg
Reach Below Ground	2.89m
Operational Full Width	3.07m

Alternative machines

G85
860SJ

Manufacturer

Genie

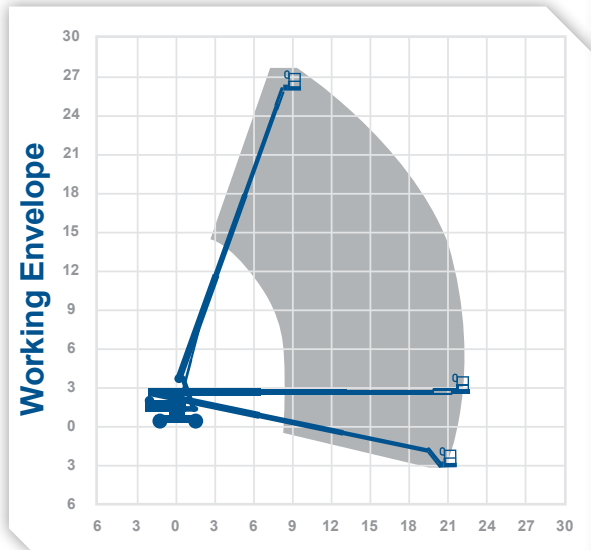

Working Height 27.9m
Horizontal Outreach 23.32m

Closed Length	12.4m
Closed Height	2.8m
Closed Width	2.5m
Platform Size	1.83m x 0.76m
Rotation	Continuous
Max SWL	227kg
Weight	17236kg
Reach Below Ground	2.89m

Alternative machines

860SJ
G85X

Manufacturer

Genie

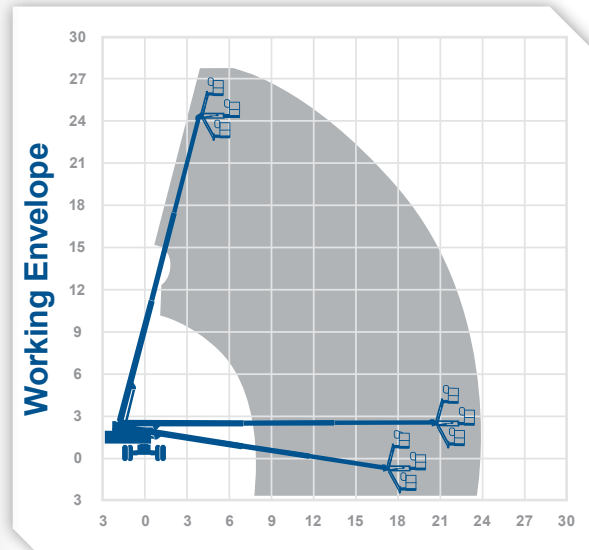

0345 745 0000
nationwideplatforms.co.uk



Nationwide Platforms
 A **LOXAM** Company

HR28H

booms

Working Height 28.0m
Horizontal Outreach 19.0m

Closed Length 9.28m
 Closed Height 2.7m
 Closed Width 2.49m
 Platform Size 2.4m x 0.9m
 Rotation 360°
 Max SWL 280kg
 Weight 14700kg

Alternative machines

Z80
80J

Manufacturer

Niftylift

fitted with manufacturers secondary guarding as standard

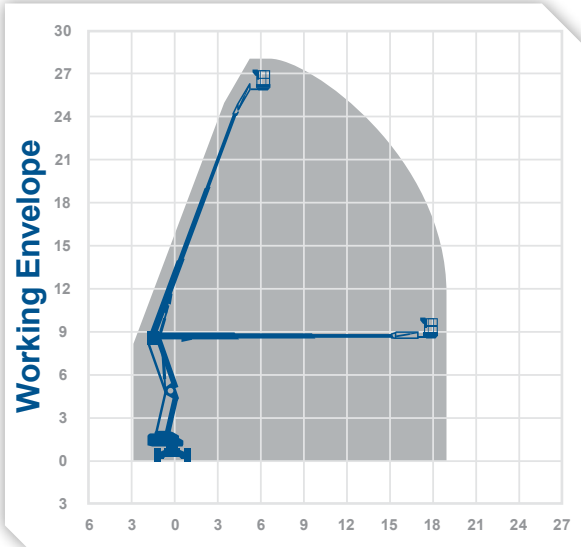

860SJ

booms

Working Height 28.21m
Horizontal Outreach 22.86m

Closed Length 12.19m
 Closed Height 3.05m
 Closed Width 2.49m
 Platform Size 2.44m x 0.91m
 Rotation 360°
 Max SWL 227kg
 Weight 16511kg
 Reach Below Ground 3.0m

Alternative machines

G85X

Manufacturer

JLG

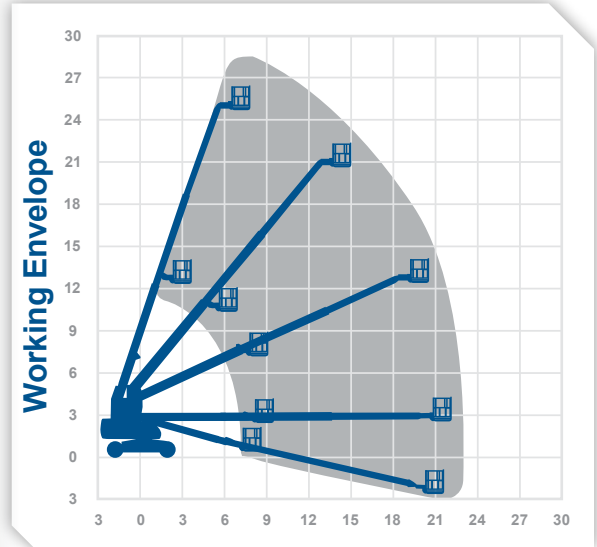

0345 745 0000
 nationwideplatforms.co.uk



Nationwide Platforms
 A Loxam Company

Working Height 31.8m
Horizontal Outreach 21.3m

Closed Length 11.16m
 Closed Height 2.7m
 Closed Width 2.5m
 Platform Size (extended) 2.44(3.33)m 0.80m
 Continuous
 Rotation 250kg
 Max SWL 20800kg
 Weight 4.0m
 Reach Below Ground

Alternative machines

1250AJP

Manufacturer

Haulotte

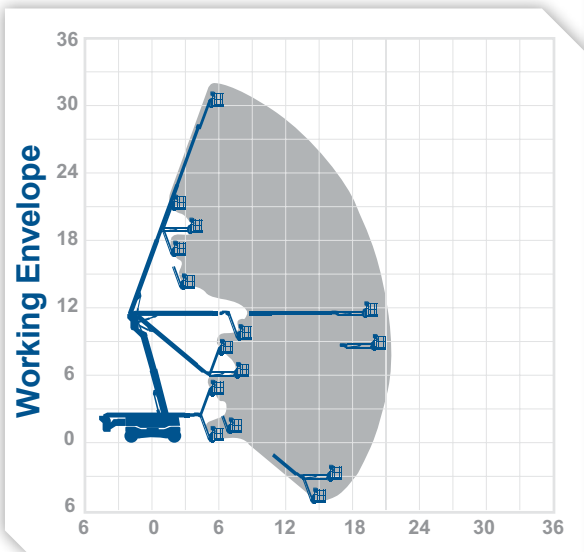

0345 745 0000
nationwideplatforms.co.uk

Working Height 38.73m
Horizontal Outreach 22.86m

Closed Length 10.64m
 Closed Height 3.05m
 Closed Width 2.49m
 Platform Size 2.44m x 0.91m
 Rotation Continuous
 Max SWL 230kg
 Weight 18500kg
 Operational Full Width 3.81m

Alternative machines

S125

Manufacturer

JLG

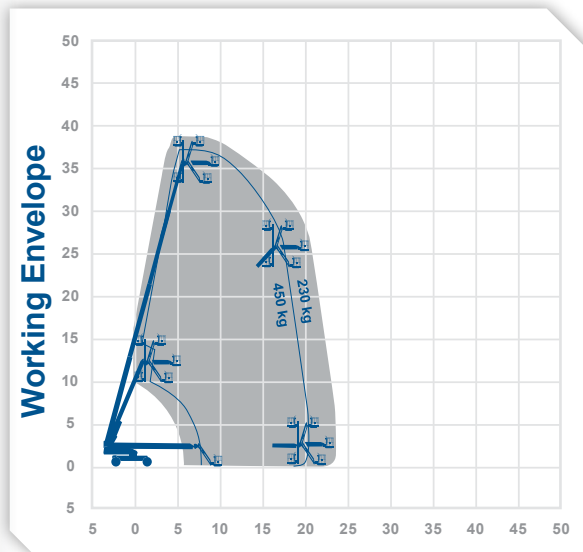

Nationwide Platforms
 A **LOXAM** Company



Working Height 40.1m
Horizontal Outreach 19.25m

Closed Length 11.45m
 Closed Height 3.05m
 Closed Width 2.49m
 Platform Size 2.44m x 0.91m
 Rotation Continuous
 Max SWL 227kg
 Weight 19958kg
 Operational Full Width 3.81m

Alternative machines

1350SJP
 Z135

Manufacturer

JLG

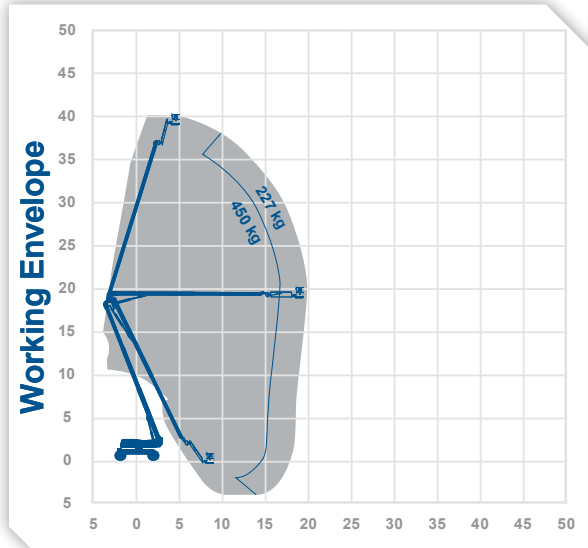

0345 745 0000
nationwideplatforms.co.uk



Working Height 40.15m
Horizontal Outreach 24.38m

Closed Length 14.25m
 Closed Height 3.07m
 Closed Width 2.49m
 Platform Size 2.44m x 0.91m
 Rotation Continuous
 Max SWL 227kg
 Weight 20248kg
 Operational Full Width 3.35m

Alternative machines

1200SJP
 1350SJP

Manufacturer

Genie

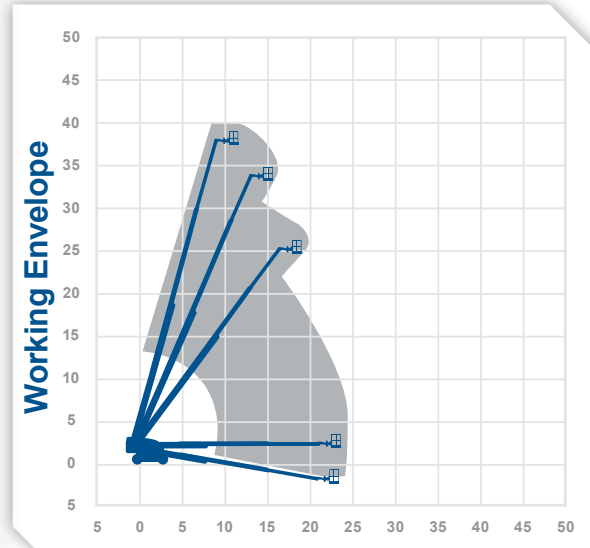

Nationwide Platforms
 A **LOXAM** Company

Working Height 41.5m
Horizontal Outreach 20.1m

Closed Length	13.1m
Closed Height	3.0m
Closed Width	2.53m
Platform Size	2.44m x 0.91m
Rotation	360°
Max SWL	230kg
Weight	23900kg
Reach Below Ground	1.5m
Operational Full Width	3.3m

Alternative machines

Z135
1250AJP

Manufacturer

Haulotte

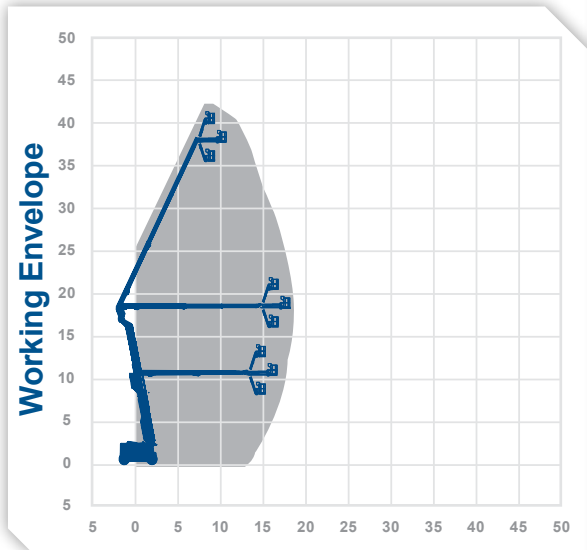

0345 745 0000
nationwideplatforms.co.uk



Working Height 43.15m
Horizontal Outreach 21.26m

Closed Length	12.93m
Closed Height	3.07m
Closed Width	2.46m
Platform Size	2.44m x 0.91m
Rotation	Continuous
Max SWL	272kg
Weight	20366kg
Reach Below Ground	5.87m
Operational Full Width	3.94m

Alternative machines

1350SJP
1250AJP
ZX135
150HAX

Manufacturer

Genie

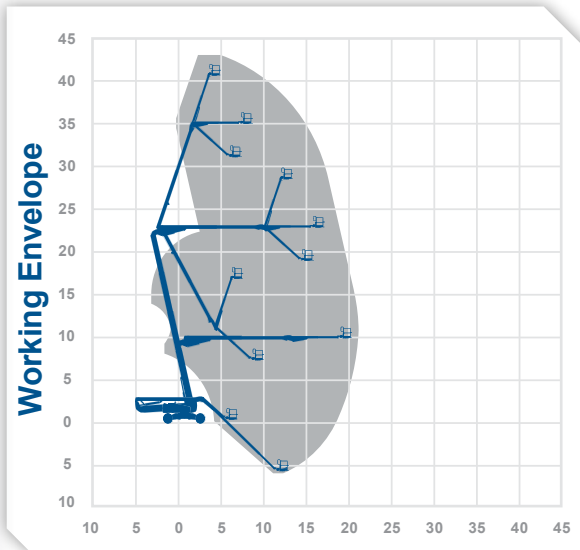

Nationwide Platforms
 A **LOXAM** Company

Working Height 43.15m
Horizontal Outreach 21.26m

Closed Length	12.93m
Closed Height	3.09m
Closed Width	2.49m
Platform Size	2.44m x 0.91m
Rotation	Continuous
Max SWL	272kg
Weight	20502kg
Reach Below Ground	5.87m
Operational Full Width	5.03m

Alternative machines

Z135
 1350SJP
 1250AJP
 150HAX

Manufacturer

Genie

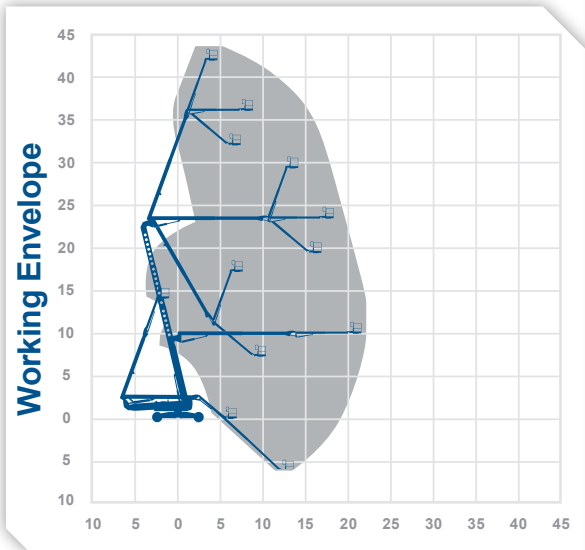

43.15m

21.26m

Working Height 43.15m
Horizontal Outreach 27.43m

Closed Length	19.76m
Closed Height	3.05m
Closed Width	2.49m
Platform Size	2.44m x 0.91m
Rotation	Continuous
Max SWL	454kg
Weight	21747kg
Reach Below Ground	6.0m
Operational Full Width	3.94m

Alternative machines
 1350SJP

Manufacturer

Genie

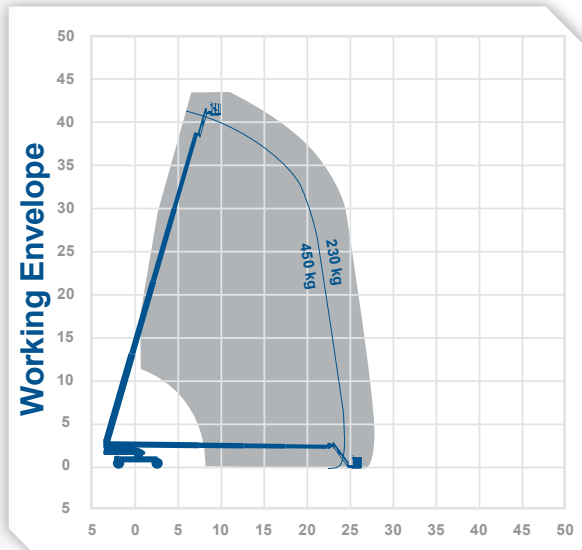

43.15m

27.43m

0345 745 0000
nationwideplatforms.co.uk



Nationwide Platforms
 A **LOXAM** Company

Working Height 43.3m
Horizontal Outreach 24.38m

Closed Length 11.86m
 Closed Height 3.05m
 Closed Width 2.49m
 Platform Size 2.44m x 0.91m
 Rotation Continuous
 Max SWL 230kg
 Weight 20400kg
 Operational Full Width 3.81m

Alternative machines

Z135
 1200SJP
 S125

Manufacturer

JLG

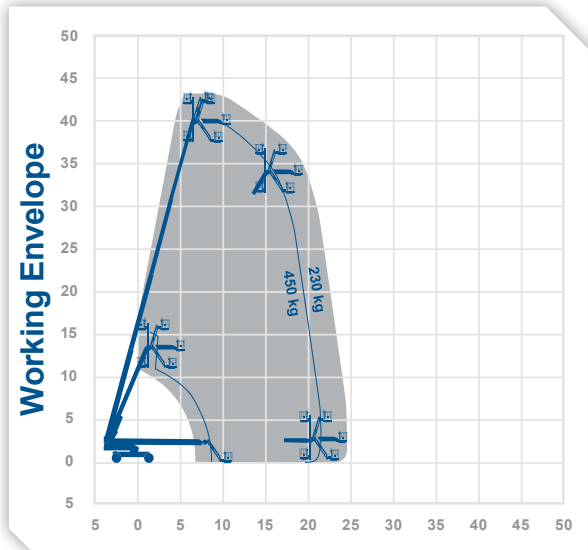

0345 745 0000
nationwideplatforms.co.uk

Working Height 48.02m
Horizontal Outreach 24.38m

Closed Length 16.18m
 Closed Height 3.05m
 Closed Width 2.49m
 Platform Size 2.44m x 0.91m
 Rotation Continuous
 Max SWL 340kg
 Weight 23236kg
 Reach Below Ground 0.91m
 Operational Full Width 5.03m

Alternative machines

SX180

Manufacturer

Genie

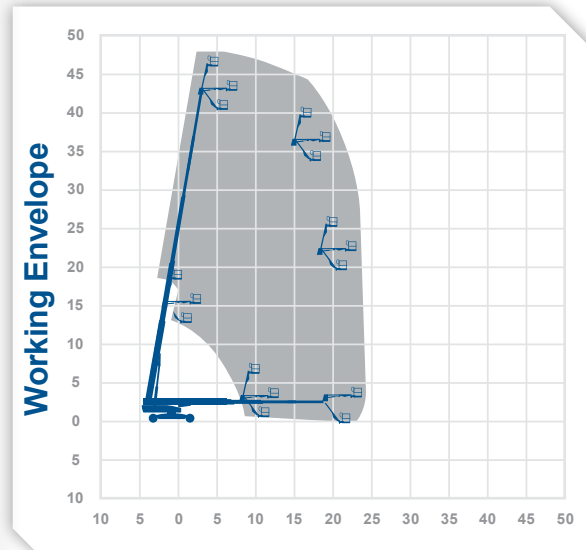

Nationwide Platforms
 A **LOXAM** Company



Working Height **48.15m** Horizontal Outreach **23.55m**

Closed Length	15.1m
Closed Height	3.1m
Closed Width	2.5m
Platform Size (extended)	2.44(5)m x 0.91m
Rotation	Continuous
Max SWL (extended)	450(270)kg
Weight	26127kg
Reach Below Ground	6.1m
Operational Full Width	5m

Manufacturer
JLG

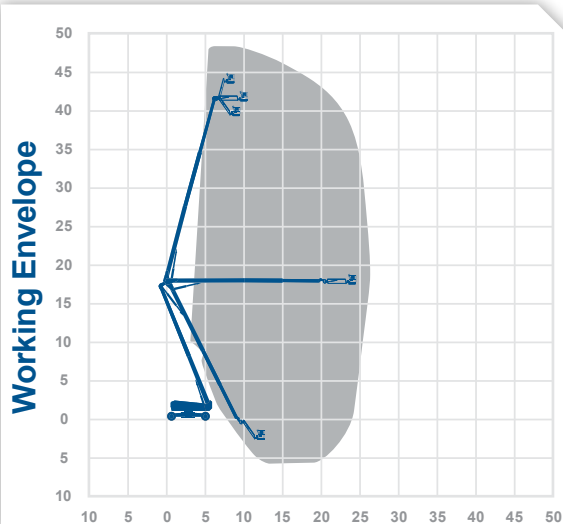

0345 745 0000
nationwideplatforms.co.uk

Working Height **56.86m** Horizontal Outreach **24.38m**

Closed Length	14.33m
Closed Height	3.05m
Closed Width	2.49m
Platform Size	2.44m x 0.91m
Rotation	Continuous
Max SWL	340kg
Weight	25095kg
Operational Full Width	5.03m

Manufacturer
Genie

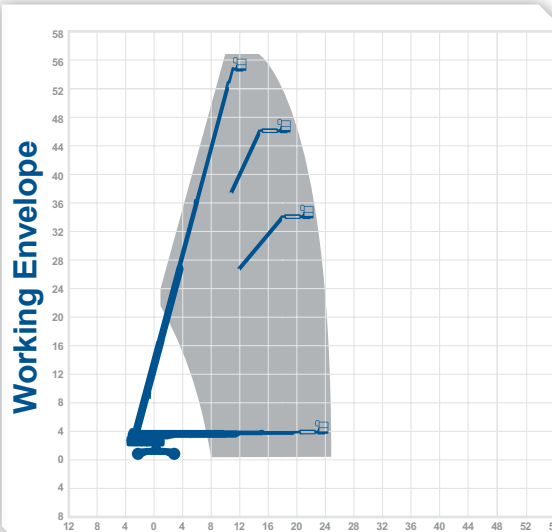

Nationwide Platforms
A **LOXAM** Company



Van Mounted



- More than 290 units available to hire across the UK
- Versalift boom assemblies on most models
- All vehicles comply to EN280:2001 and are CE certified
- Dual roof mounted beacons/working lights
- Reverse alarms and night switches
- Steel bulkheads
- Internal racking, ply lining and hot and cold hand wash unit option available
- Tracker devices available as options on long term hires
- Operated or self-drive options available

Machine type by product code

VT125K

V14E

VT12E

V16E



0345 745 0000
nationwideplatforms.co.uk



Nationwide Platforms
A **LOXAM** Company

VT125K

van
mounts

Working Height 12.0m Horizontal Outreach 7.0m

Max Horiz. Outreach (full SWL)	7.0m
Overall travel Length	6.8m
Overall travel Height	3.3m
Overall travel Width	2.2m
Platform/cage size	1.0m x 0.60m
Max SWL	200kg
Gross vehicle weight class	3500kg
Operational Full Width	2.45m
Minimum Operational width (straight down jacking)	As above

Alternative machines

V12E
VI125K

Manufacturer

GSR

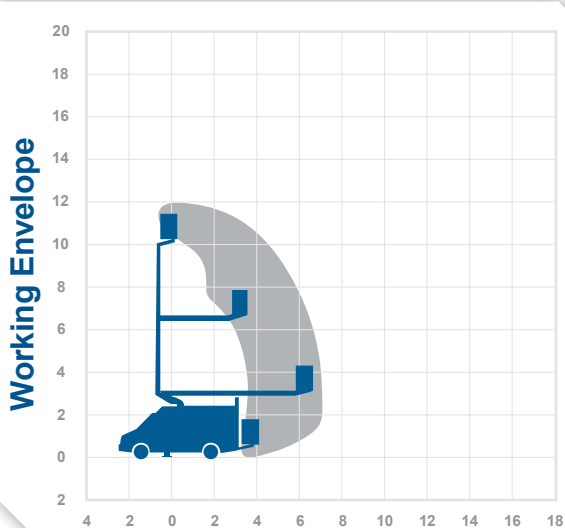

0345 745 0000
nationwideplatforms.co.uk



VT12E

van
mounts

Working Height 13.0m Horizontal Outreach 7.0m

Max Horiz. Outreach (full SWL)	7.0m
Overall travel Length	6.74m
Overall travel Height	3.15m
Overall travel Width	2.2m
Platform/cage size	1.0m x 0.60m
Max SWL	200kg
Gross vehicle weight class	3500kg
Operational Full Width	2.45m
Minimum Operational width (straight down jacking)	As above

Alternative machines

V14E

Manufacturer

Versalift

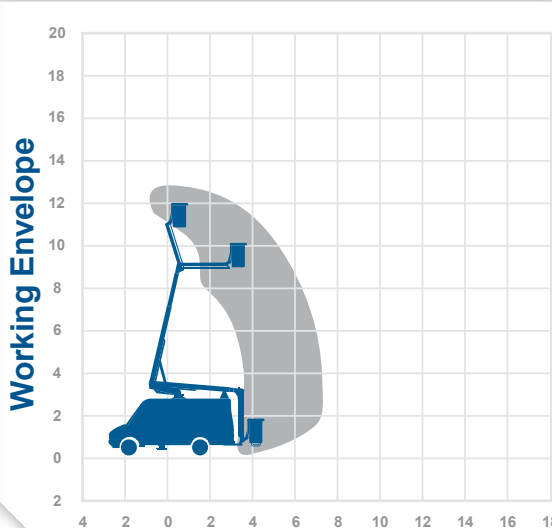

Nationwide Platforms
A Loxam Company

V14E

van
mounts

Working Height 14.2m Horizontal Outreach 7.3m

Max Horiz. Outreach (full SWL)	7.3m
Overall travel Length	7.34m
Overall travel Height	3.8m
Overall travel Width	2.2m
Platform/cage size	1.0m x 0.6m
Max SWL	200kg
Gross vehicle weight class	5200kg
Operational Full Width	2.25m
Minimum Operational width (straight down jacking)	As above

Alternative machines

V16E

Manufacturer

Versalift

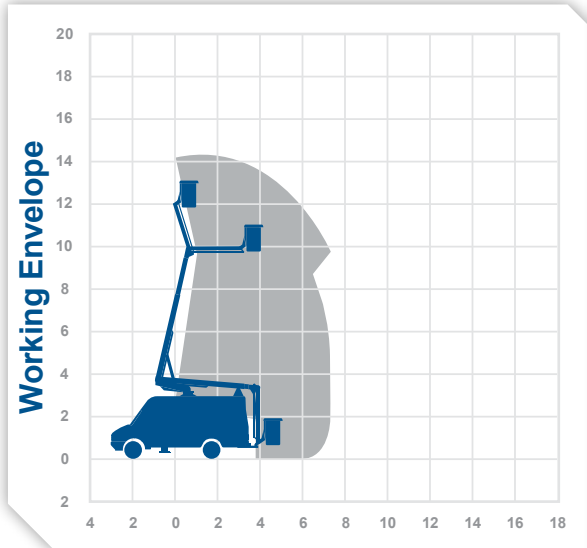

0345 745 0000
nationwideplatforms.co.uk

V16E

van
mounts

Working Height 16.5m Horizontal Outreach 7.3m

Max Horiz. Outreach (full SWL)	7.3m
Overall travel Length	8.22m
Overall travel Height	4.0m
Overall travel Width	2.2m
Platform/cage size	1.0m x 0.6m
Max SWL	200kg
Gross vehicle weight class	6500kg
Operational Full Width	2.45m
Minimum Operational width (straight down jacking)	As above

Alternative machines

T16N
T17GS

Manufacturer

Versalift

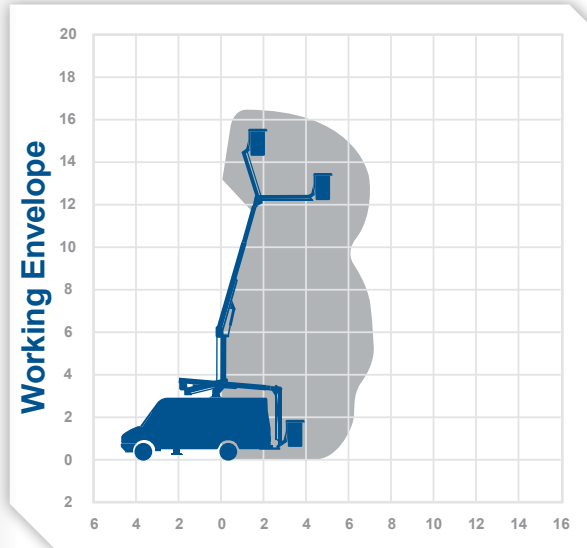

Nationwide Platforms
A **LOXAM** Company



Truck Mounted



- More than 300 units available to hire across the UK
- Working heights from 13m to 90m
- Self drive options up to 26m (3.5T and 7.5T chassis)
- All vehicles available with experienced IPAF trained operators
- Most cost effective method of access for short term hires
- Large fleet of 4 wheel drive machines – ideal for off road application
- Narrow jacking and zero tail swing models available
- Models with SWL of up to 700kg

Machine type by product code

T1135EX	T22AS	T38B
T14GS	T22GS	T44B
T17BE	T22GSH	T46B
T17GS	T26CX	T48P
T18AS	T26GS	T50JB
T18ASH	T27R	T56B-XR
T20HC	T28RX	T58R
T20GS	T33R	T70B
T20M	T33RH	T70B-XR
T21JC	T37R	T90B

0345 745 0000
nationwideplatforms.co.uk



Nationwide Platforms
A **LOXAM** Company

T1135EX

truck
mounts

Working Height 13.3m Outreach 6.1m

Max Reach Below 0m	n/a
Overall Travel Length	4.7m
Overall Travel Height	2.6m
Overall Travel Width	2.0m
Platform Cage Size	1.0m X 0.6m
Max SWL	230kg
Gross Vehicle Weight	3500kg
Operational Full Width	2.4m
Minimum Operational Width	2.4m
Point Load Front / Rear	20kN / 20kN

Manufacturer
Versalift

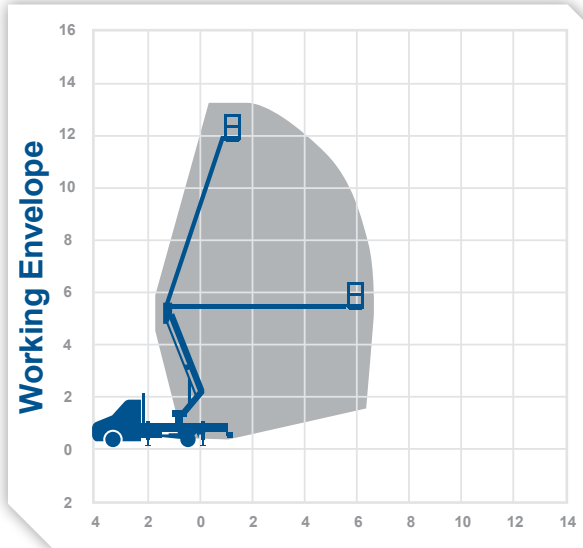

0345 745 0000
nationwideplatforms.co.uk

T14GS

truck
mounts

Working Height 14.0m Outreach 8.0m

Overall Travel Length	7.2m
Overall Travel Height	2.95m
Overall Travel Width	2.1m
Platform Cage Size	1.4m x 0.7m
Max SWL	200kg
Gross Vehicle Weight	3500kg
Operational Full Width	2.4m
Minimum Operational Width	2.4m
Point Load Front / Rear	28kN / 28kN

Manufacturer
GSR

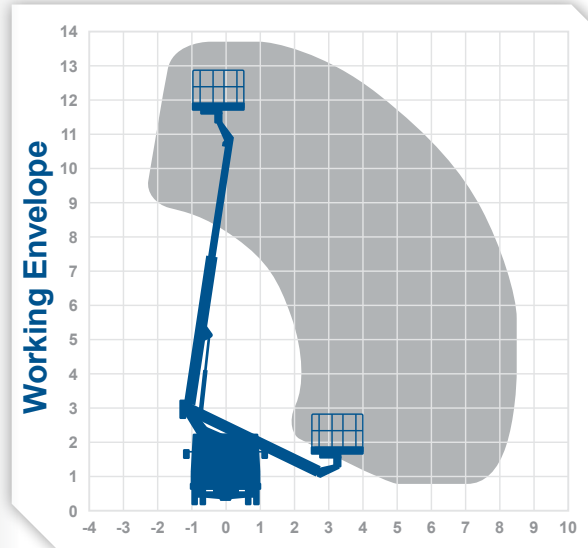

Nationwide Platforms
A Loxam Company



T17BE

truck mounts

Working Height 17.2m
Outreach 10.0m

Max Horiz. Outreach (full SWL)	8.0m
Overall Travel Length	7.2m
Overall Travel Height	3.7m
Overall Travel Width	2.5m
Platform Cage Size	1.0m x 0.6m
Max SWL	265kg
Gross Vehicle Weight	6500kg
Operational Full Width	2.4m
Minimum Operational Width	2.4m
Point Load Front / Rear	60kN / 60kN

Alternative machines

T18AS

Manufacturer

Versalift

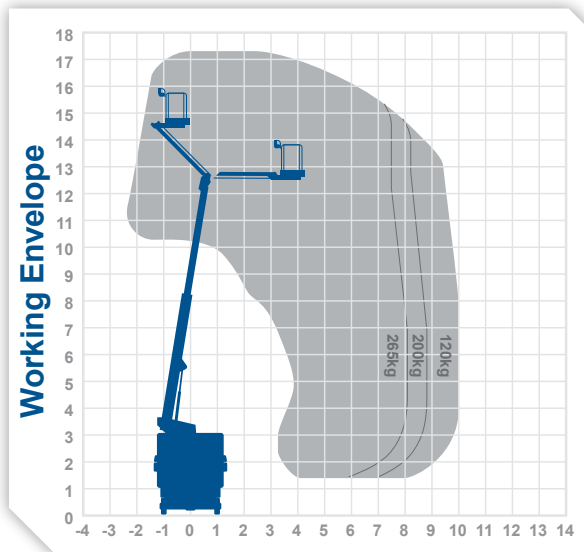

T17GS

truck mounts

Working Height 17.1m
Outreach 9.5m

Max Horiz. Outreach (full SWL)	6.7m
Overall Travel Length	7.1m
Overall Travel Height	2.95m
Overall Travel Width	2.2m
Platform Cage Size	1.4m x 0.7m
Max SWL	250kg
Gross Vehicle Weight	3500kg
Operational Full Width	2.4m
Minimum Operational Width	2.4m
Point Load Front / Rear	28kN / 28kN

Alternative machines

T18AS

Manufacturer

GSR

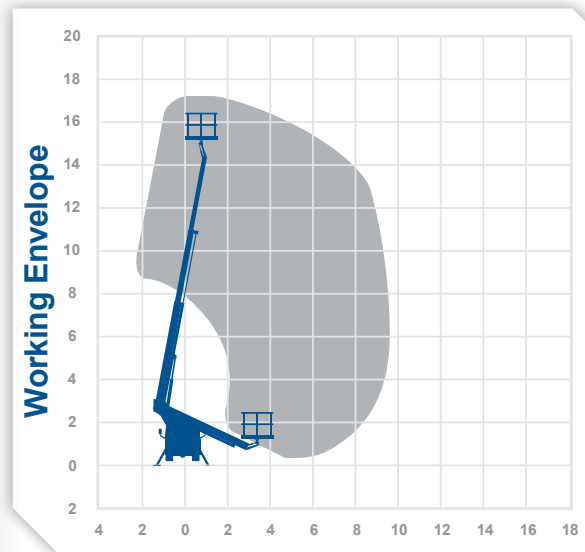

0345 745 0000
nationwideplatforms.co.uk



Nationwide Platforms
A **LOXAM** Company

T18AS

truck
mounts

Working Height 18.0m
Outreach 13.0m

Overall Travel Length	7.0m
Overall Travel Height	3.0m
Overall Travel Width	2.3m
Platform Cage Size	1.4m x 0.73m
Max SWL	230kg
Gross Vehicle Weight	3500kg
Operational Full Width	3.6m
Minimum Operational Width	2.3m
Point Load Front / Rear	28kN / 28kN

Alternative machines

T18ASH
T20M
T20HC
T20GS

Manufacturer

Ascendant

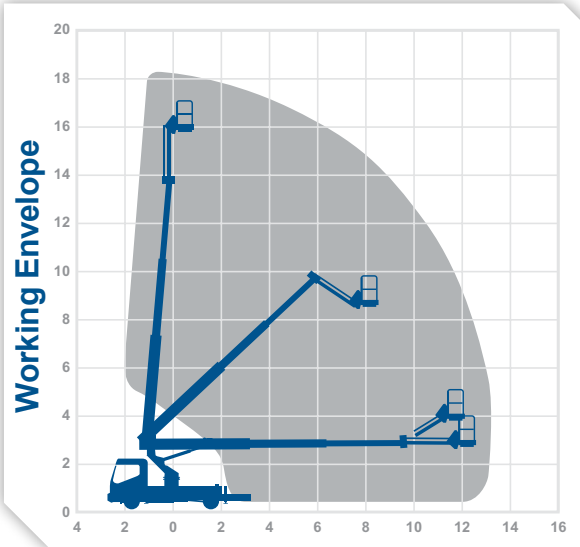

0345 745 0000
nationwideplatforms.co.uk

T18ASH

truck
mounts

Working Height 18.0m
Outreach 13.0m

Max Horiz. Outreach (full SWL)	13.0m
Overall Travel Length	7.0m
Overall Travel Height	3.0m
Overall Travel Width	2.1m
Platform Cage Size	1.4m x 0.73m
Max SWL	230kg
Gross Vehicle Weight	5000kg
Operational Full Width	3.8m
Minimum Operational Width	2.3m
Point Load Front / Rear	50kN / 50kN

Alternative machines

T18AS

Manufacturer

Ascendant

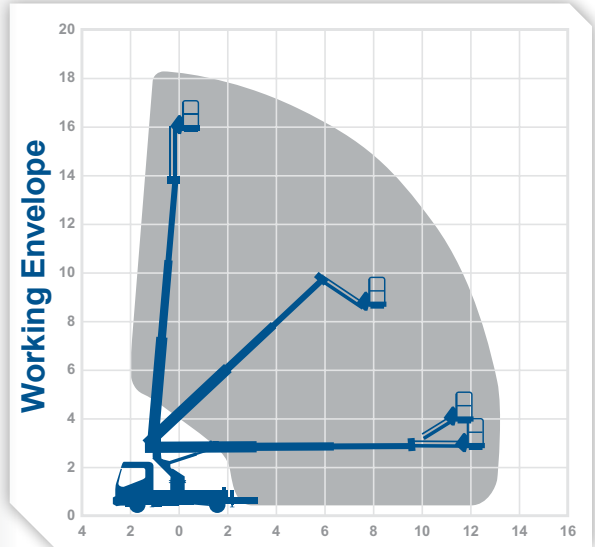

Nationwide Platforms
A **LOXAM** Company



T20HC



Working Height 20.0m
Outreach 9.0m

Overall Travel Length	6.76m
Overall Travel Height	2.5m
Overall Travel Width	2.1m
Platform Cage Size	1.4m x 0.7m
Max SWL	300kg
Gross Vehicle Weight	3500kg
Operational Full Width	2.93m
Minimum Operational Width	2.93m
Point Load Front / Rear	28kN / 28kN

Alternative machines

T20M

Manufacturer

CTE

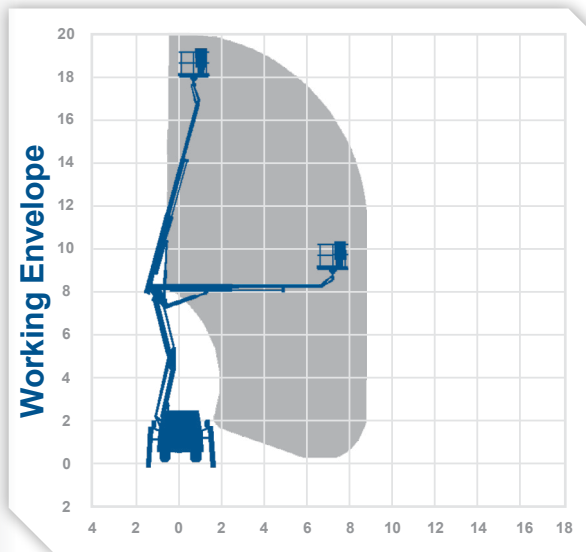

0345 745 0000
nationwideplatforms.co.uk



Nationwide Platforms
A **LOXAM** Company

T20GS

truck
mounts

Working Height 20.0m Outreach 8.2m

Overall Travel Length	7.46m
Overall Travel Height	2.77m
Overall Travel Width	2.1m
Platform Cage Size	1.4m x 0.7m
Max SWL	280kg
Gross Vehicle Weight	3500kg
Operational Full Width	2.3m
Minimum Operational Width	2.3m
Point Load Front / Rear	25kN / 18kN

Alternative machines

Manufacturer

GSR

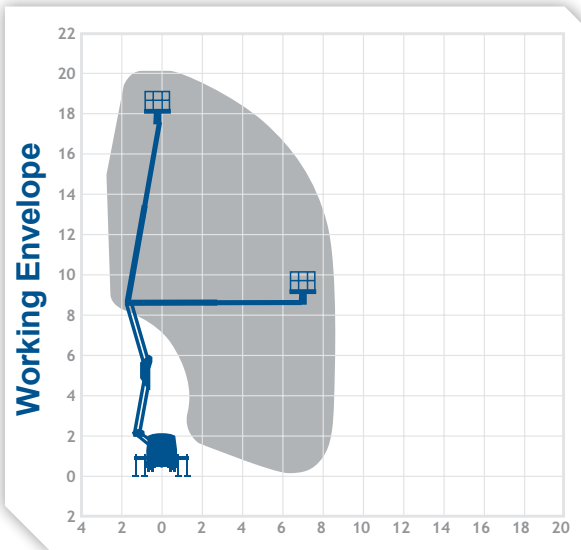

0345 745 0000
nationwideplatforms.co.uk

T20M

truck
mounts

Working Height 20.0m Outreach 11.0m (80kg)

Max Horiz. Outreach (full SWL)	8.6m
Max Reach Below 0m	2.0m
Overall Travel Length	7.65m
Overall Travel Height	3.0m
Overall Travel Width	2.1m
Platform Cage Size	1.4m x 0.7m
Max SWL	250kg
Gross Vehicle Weight	3500kg
Operational Full Width	3.4m
Minimum Operational Width	2.5m
Point Load Front / Rear	30kN / 19kN

Alternative machines

T20C
T21JC

Manufacturer

Multitel

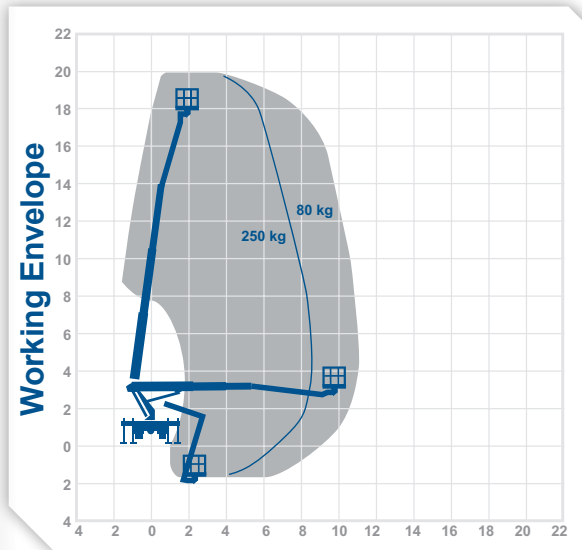

Nationwide Platforms
A Loxam Company



T21JC

truck
mounts

Working Height 21.0m Outreach 10.0m

Max Reach Below 0m	n/a
Overall Travel Length	6.8m
Overall Travel Height	2.6m
Overall Travel Width	2.1m
Platform Cage Size	1.4m x 0.7m
Max SWL	280kg
Gross Vehicle Weight	3500kg
Operational Full Width	2.9m
Minimum Operational Width	2.9m
Point Load Front / Rear	28kN / 28kN

Alternative machines

T20C
T20M

Manufacturer

CTE

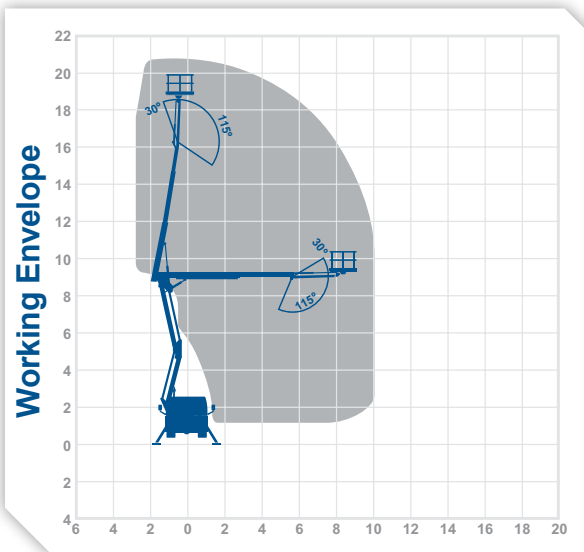

T22AS

truck
mounts

Working Height 22.0m Outreach 17.5m

Max Reach Below 0m	n/a
Overall Travel Length	9.2m
Overall Travel Height	3.5m
Overall Travel Width	2.4m
Platform Cage Size	1.8m x 1.1m
Max SWL*	280kg
Gross Vehicle Weight	7500kg
Operational Full Width	4.5m
Minimum Operational Width	2.5m
Point Load Front / Rear	60kN / 60kN

Alternative machines

T22GS

Manufacturer

Ascendant

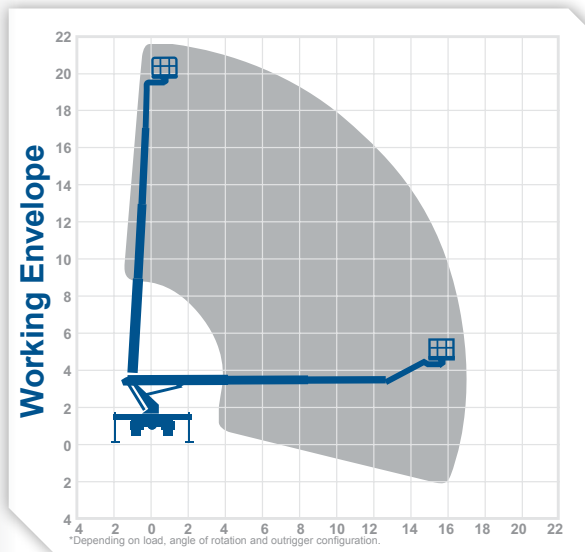

0345 745 0000
nationwideplatforms.co.uk



Nationwide Platforms
A **LOXAM** Company

T22GS

truck
mounts

Working Height 22.0m
Outreach 17.7m

Max Reach Below 0m	n/a
Overall Travel Length	8.7m
Overall Travel Height	3.55m
Overall Travel Width	2.5m
Platform Cage Size	1.8m x 0.8m
Max SWL*	280kg
Gross Vehicle Weight	7500kg
Operational Full Width	4.5m
Minimum Operational Width	2.5m
Point Load Front / Rear	60kN / 60kN

Alternative machines

T22AS

Manufacturer

GSR

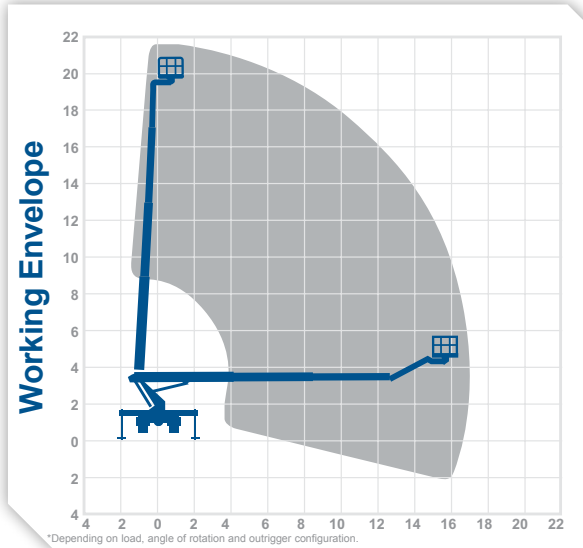

T22GSH

truck
mounts

Working Height 22.0m
Outreach 17.7m

Max Reach Below 0m	n/a
Overall Travel Length	8.7m
Overall Travel Height	3.55m
Overall Travel Width	2.5m
Platform Cage Size	1.8m x 0.8m
Max SWL	280kg
Gross Vehicle Weight	8200kg
Operational Full Width	4.5m
Minimum Operational Width	2.5m
Point Load Front / Rear	60kN / 60kN

Alternative machines

T22GS

Manufacturer

GSR

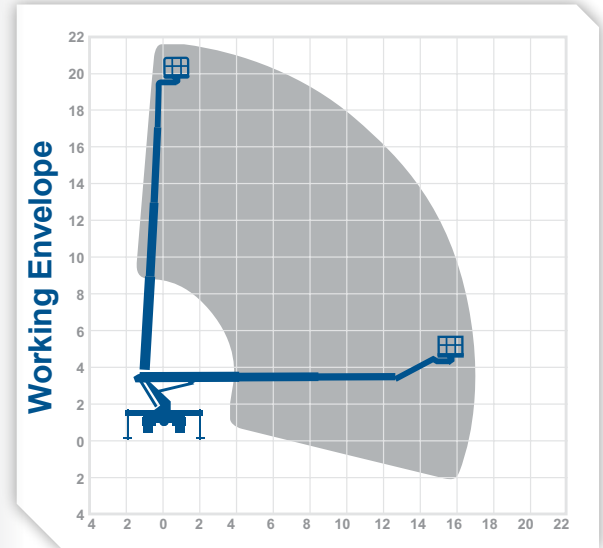

0345 745 0000
nationwideplatforms.co.uk



Nationwide Platforms
A Loxam Company

T26CX

truck
mounts

Working Height 26.0m Outreach 12.5m

Overall Travel Length	7.45m
Overall Travel Height	3.9m
Overall Travel Width	2.6m
Platform Cage Size	1.4m x 0.7m
Max SWL	230kg
Gross Vehicle Weight	14000kg
Operational Full Width	3.12m
Minimum Operational Width	3.12m
Point Load Front / Rear	140kN / 140kN

Alternative machines

T26WX
T26KX

Manufacturer

CTE

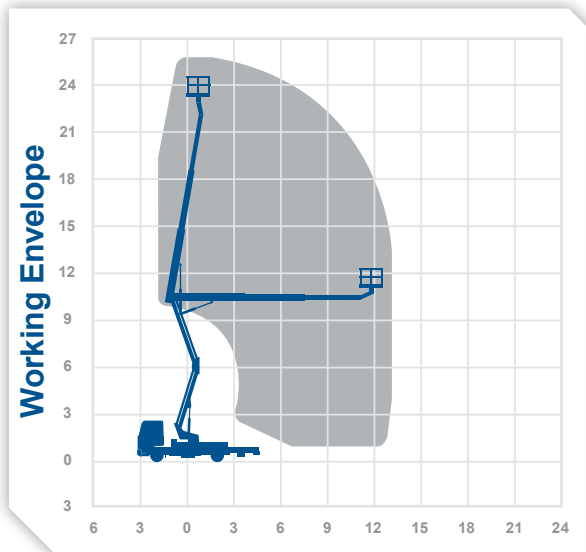

T26GS

truck
mounts

Working Height 26.0m Outreach 14.0m (280kg)

Max Horiz. Outreach (full SWL)	14.0m
Overall Travel Length	7.8m
Overall Travel Height	3.6m
Overall Travel Width	2.5m
Platform Cage Size	1.4m x 0.7m
Max SWL	280kg
Gross Vehicle Weight	7500kg
Operational Full Width	3.5m
Minimum Operational Width	3.5m
Point Load Front / Rear	60kN / 60kN

Alternative machines

T26C

Manufacturer

GSR

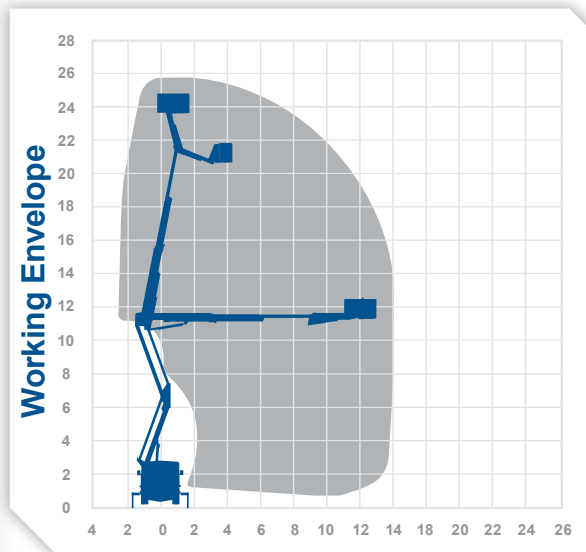

0345 745 0000
nationwideplatforms.co.uk



Nationwide Platforms
A **LOXAM** Company

T27R

truck mounts

Working Height 27.0m
Outreach** 21.0m (100kg)

Max Horiz. Outreach (full SWL)	16.0m
Max Reach Below 0m	n/a
Overall Travel Length	7.87m
Overall Travel Height	3.3m
Overall Travel Width	2.54m
Platform Cage Size	1.85m x 1.0m
Max SWL	320kg
Gross Vehicle Weight	7500kg
Operational Full Width	5.1m
Minimum Operational Width	2.5m
Point Load Front / Rear	72kN / 55kN

Alternative machines

T26C

Manufacturer
Ruthman



Working Envelope

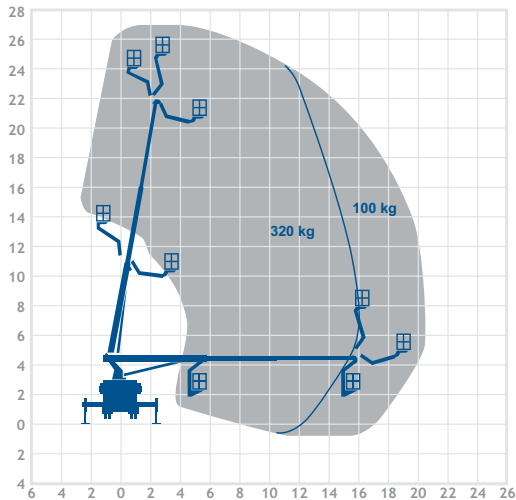

**Depending on load, angle of rotation and outrigger configuration.

T28RX

truck mounts

Working Height 28.0m
Outreach** 21.3m (100kg)

Max Horiz. Outreach (full SWL)	16.0m
Max Reach Below 0m	n/a
Overall Travel Length	8.12m
Overall Travel Height	3.8m
Overall Travel Width	2.5m
Platform Cage Size	1.7m x 0.86m
Max SWL	320kg
Gross Vehicle Weight	11000kg
Operational Full Width	3.8m
Minimum Operational Width	2.5m
Point Load Front / Rear	110kN / 50kN

Alternative machines

T26CX

Manufacturer
Ruthman



Working Envelope

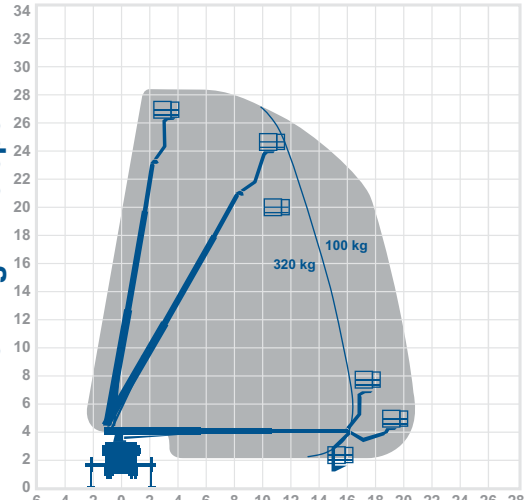

**Depending on load, angle of rotation and outrigger configuration.

0345 745 0000
nationwideplatforms.co.uk



Nationwide Platforms
A **LOXAM** Company

Working Height 33.0m
Outreach** 21.2m (100kg)

Max Horiz. Outreach (full SWL)	16.5m
Overall Travel Length	8.7m
Overall Travel Height	3.56m
Overall Travel Width	2.5m
Platform Cage Size	1.7m x 0.86m
Max SWL	320kg
Gross Vehicle Weight	7490kg
Operational Full Width	5.32m
Minimum Operational Width	2.53m
Point Load Front / Rear	56kN / 42kN

Alternative machines

T33RH

Manufacturer

Ruthman

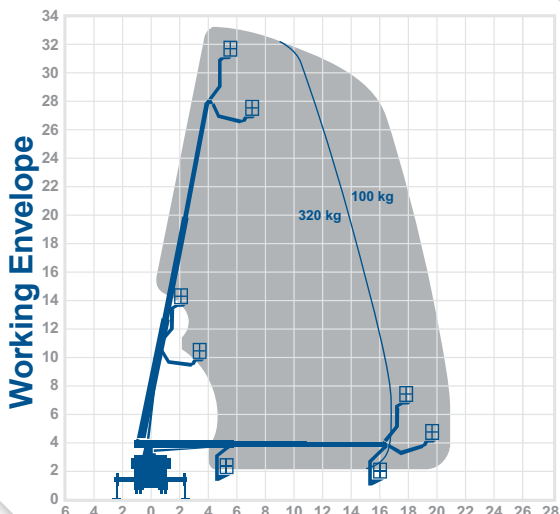

** Depending on load, angle of rotation and outrigger configuration.

Working Height 33.0m
Outreach** 21.2m (100kg)

Max Horiz. Outreach (full SWL)	16.5m
Max Reach Below 0m	n/a
Overall Travel Length	8.7m
Overall Travel Height	3.56m
Overall Travel Width	2.5m
Platform Cage Size	1.7m x 0.86m
Max SWL	320kg
Gross Vehicle Weight	8600kg
Operational Full Width	5.32m
Minimum Operational Width	2.53m
Point Load Front / Rear	56kN / 42kN

Alternative machines

T37R
T38B

Manufacturer

Ruthman

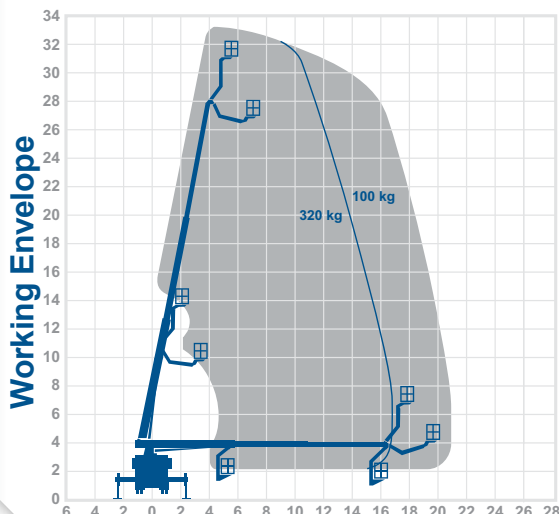

** Depending on load, angle of rotation and outrigger configuration.

0345 745 0000
nationwideplatforms.co.uk



Nationwide Platforms
A **LOXAM** Company



Working Height 37.0m
Outreach** 30.0m (100kg)

Max Horiz. Outreach (full SWL)	21.0m
Max Reach Below 0m	6.0m
Overall Travel Length	8.9m
Overall Travel Height	3.9m
Overall Travel Width	2.55m
Platform Cage Size (extended)	2.3(3.6)m x 0.9m
Max SWL	500kg
Gross Vehicle Weight	18000kg
Operational Full Width	6.4m
Minimum Operational Width	2.6m
Point Load Front / Rear	170kN / 140kN

Alternative machines

T38B

Manufacturer

Ruthman

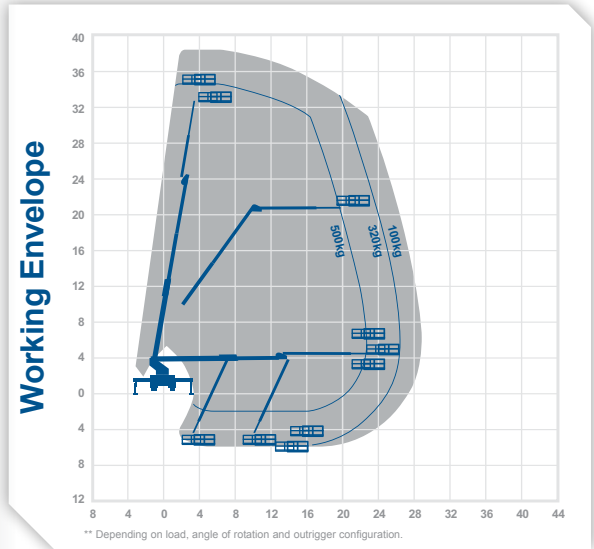

** Depending on load, angle of rotation and outrigger configuration.

0345 745 0000
nationwideplatforms.co.uk



Nationwide Platforms
 A **LOXAM** Company

37.0m
 30.0m

T38B

truck mounts

Working Height 38.0m
Outreach** 25.3m (120kg)

Max Horiz. Outreach (full SWL)	21.0m
Max Reach Below 0m	6.5m
Overall Travel Length	10.0m
Overall Travel Height	3.7m
Overall Travel Width	2.5m
Platform Cage Size (extended)	2.3(3.7)m x 1.05m
Max SWL	600kg
Gross Vehicle Weight	18000kg
Operational Full Width	6.2m
Minimum Operational Width	2.8m
Point Load Front / Rear	150kN / 150kN

Alternative machines

T37B
T37R

Manufacturer

Bronto

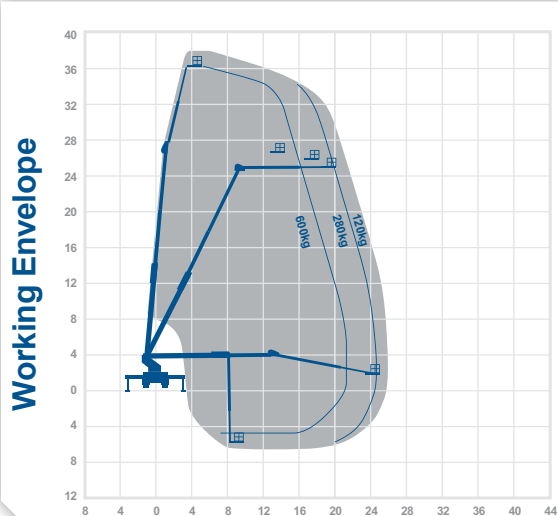

** Depending on load, angle of rotation and outrigger configuration.

T44B

truck mounts

Working Height 44.0m
Outreach** 24.0m (120kg)

Max Horiz. Outreach (full SWL)	21.0m
Max Reach Below 0m	5.0m
Overall Travel Length	10.0m
Overall Travel Height	3.8m
Overall Travel Width	2.5m
Platform Cage Size	2.4(3.7)m x 1.0m
Max SWL	600kg
Gross Vehicle Weight	18000kg
Operational Full Width	6.2m
Minimum Operational Width	2.8m
Point Load Front / Rear	150kN / 150kN

Alternative machines

T46B

Manufacturer

Bronto

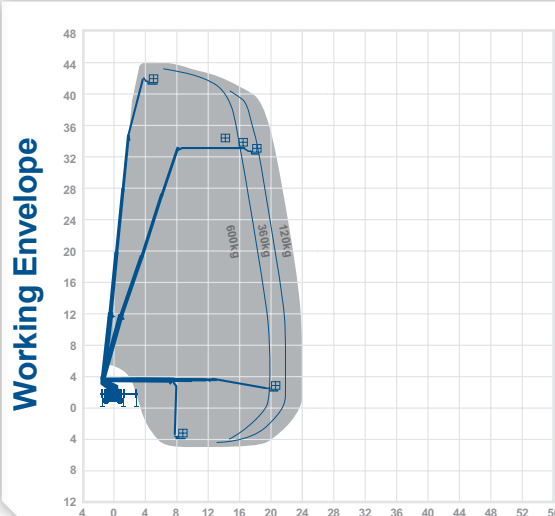

** Depending on load, angle of rotation and outrigger configuration.

0345 745 0000
nationwideplatforms.co.uk



Nationwide Platforms
A **LOXAM** Company

T46B

truck mounts

Working Height 46.0m
Outreach** 24.5m (120kg)

Max Horiz. Outreach (full SWL)	20.0m
Max Reach Below 0m	6.5m
Overall Travel Length	10.5m
Overall Travel Height	3.7m
Overall Travel Width	2.5m
Platform Cage Size	2.47m x 1.05m
Max SWL	600kg
Gross Vehicle Weight	18000kg
Operational Full Width	6.2m
Minimum Operational Width	2.8m
Point Load Front / Rear	150kN / 150kN

Alternative machines

T48P
T50JB

Manufacturer

Bronto

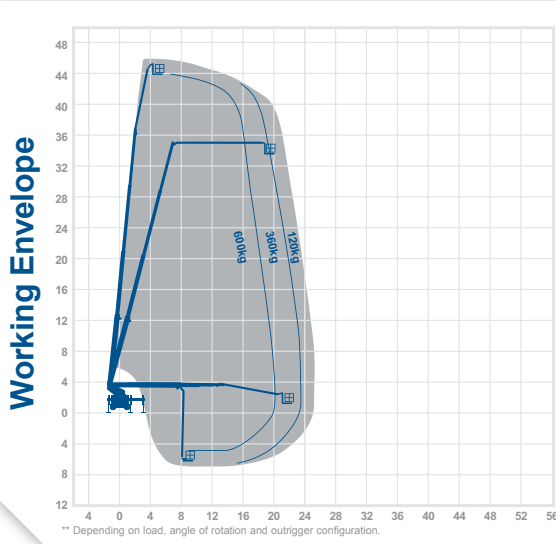

T48P

truck mounts

Working Height 48.0m
Outreach** 28.0m (100kg)

Max Horiz. Outreach (full SWL)	22.0m
Max Reach Below 0m	13.5m
Overall Travel Length	10.4m
Overall Travel Height	4.0m
Overall Travel Width	2.55m
Platform Cage Size (extended)	2.15(3.8)m x 1.05m
Max SWL	600kg
Gross Vehicle Weight	17600kg
Operational Full Width	6.3m
Minimum Operational Width	2.55m
Point Load Front / Rear	160kN / 160kN

Alternative machines

T50JB

Manufacturer

Palfinger

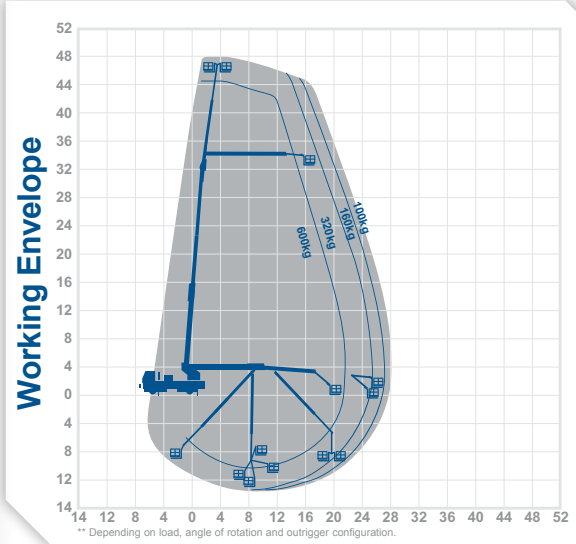

0345 745 0000
nationwideplatforms.co.uk



Nationwide Platforms
A **LOXAM** Company

T50JB

truck
mounts

Working Height 50.0m
Outreach** 35.0m (120kg)

Max Horiz. Outreach (full SWL)	25.0m
Max Reach Below 0m	11.0m
Overall Travel Length	12.0m
Overall Travel Height	4.0m
Overall Travel Width	2.5m
Platform Cage Size (extended)	2.2(3.7)m x 0.9m
Max SWL	600kg
Gross Vehicle Weight	26000kg
Operational Full Width	8.0m
Minimum Operational Width	2.8m
Point Load Front / Rear	190kN / 190kN

Alternative machines

T58B
T48P
T56B

Manufacturer

Bronto

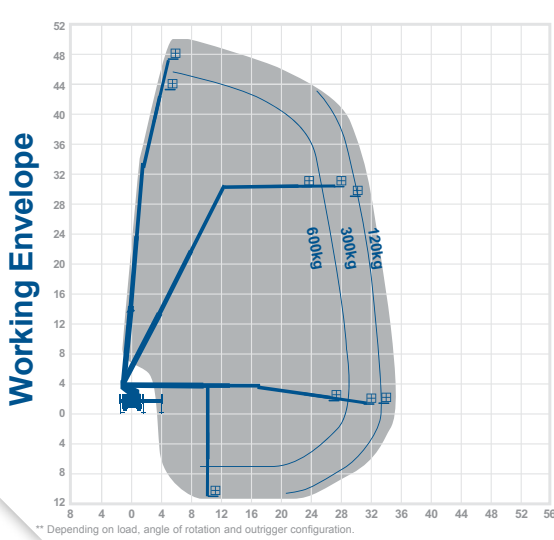

** Depending on load, angle of rotation and outrigger configuration.

T56B-XR

truck
mounts

Working Height 56.0m
Outreach** 37.3m (200kg)

Max Horiz. Outreach (full SWL)	32.0m
Max Reach Below 0m	9.0m
Overall Travel Length	11.9m
Overall Travel Height	3.7m
Overall Travel Width	2.5m
Platform Cage Size (extended)	2.4(3.7)m x 1.0m
Max SWL	600kg
Gross Vehicle Weight	26000kg
Operational Full Width	9.0m
Minimum Operational Width	3.0m
Point Load Front / Rear	180kN / 180kN

Alternative machines

T50JB

Manufacturer

Bronto

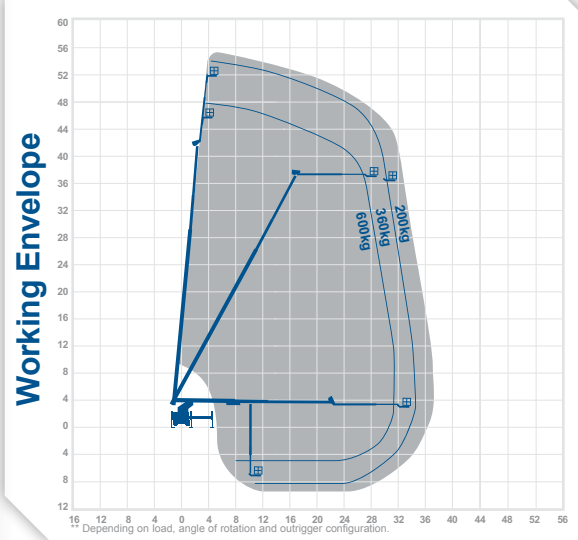

** Depending on load, angle of rotation and outrigger configuration.

0345 745 0000
nationwideplatforms.co.uk



Nationwide Platforms
A **LOXAM** Company

T58R

truck
mounts

Working Height 58.0m
Outreach** 38.0m (100kg)

Max Horiz. Outreach (full SWL)	31.0m
Max Reach Below 0m	6.0m
Overall Travel Length	11.7m
Overall Travel Height	3.99m
Overall Travel Width	2.55m
Platform Cage Size (extended)	2.3(3.6)m x 0.9m
Max SWL	500kg
Gross Vehicle Weight	26000kg
Operational Full Width	9.67m
Minimum Operational Width	2.85m
Point Load Front / Rear	220kN / 220kN

Alternative machines

T70B
T66M-1
T56B

Manufacturer
Ruthman



Working Envelope

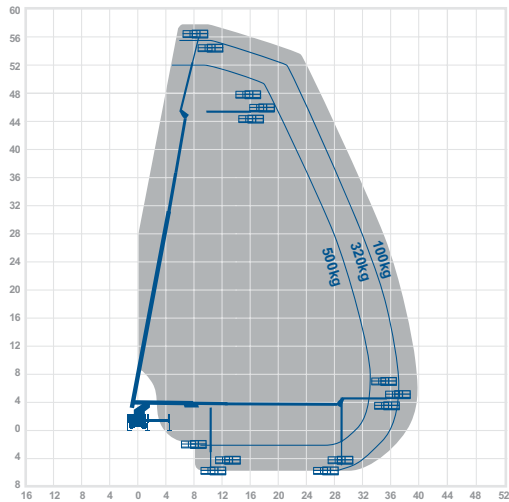

** Depending on load, angle of rotation and outrigger configuration.

T70B

truck
mounts

Working Height 70.0m
Outreach 34.8m (120kg)

Max Horiz. Outreach (full SWL)	30.0m
Max Reach Below 0m	6.0m
Overall Travel Length	12.5m
Overall Travel Height	4.2m
Overall Travel Width	2.5m
Platform Cage Size (extended)	2.4(3.7)m x 1.0m
Max SWL	600kg
Gross Vehicle Weight	36000kg
Operational Full Width	8.0m
Minimum Operational Width	3.2m
Point Load Front / Rear	255kN / 255kN

Alternative machines

T90B

Manufacturer
Bronto

Cage winch option available
Extra capacity basket available 2020



Working Envelope

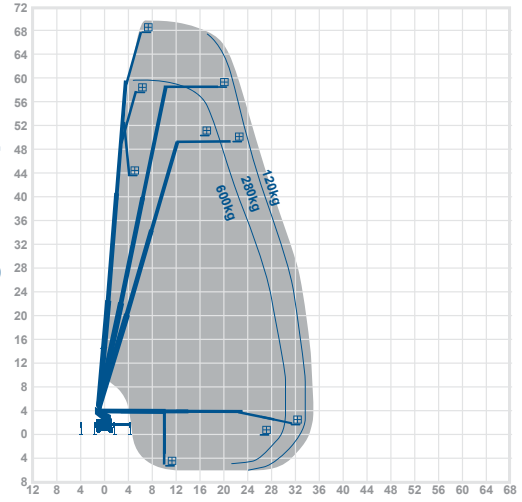

0345 745 0000
nationwideplatforms.co.uk



Nationwide Platforms
A **LOXAM** Company

Tracked Booms



- More than 130 available to hire on either operated or self-operated basis
- Can be operated with IPAF 1b license
- Allows access to restricted areas that traditional booms can't
- Lithium battery models are available
- Reduces the ground bearing pressure on soft ground and delicate flooring
- Allows greater stability for work on uneven surfaces
- Easily transportable
- Can be used for a variety of applications including facilities management and retail
- Working heights up to 31m

Machine type by product code

TB14HB

TB14HE

TB15HB

TB15HE

TB17HB

TB17HE

TB18PB

TB20HB

TB20HE

TB20JB

TB26HB

TB26HE

TB30MB

TB31TB

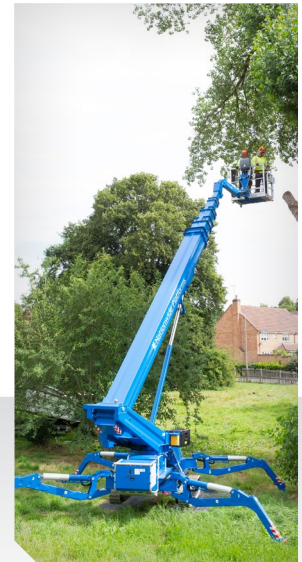

0345 745 0000
nationwideplatforms.co.uk



Nationwide Platforms
A **LOXAM** Company

TB14HB

tracked
booms

Working Height 14.0m

Horizontal Outreach 7.0m

Closed Length	4.06m
Closed Height	1.99m
Rails Up / Fixed Rails	
Closed Width	0.78m
DeckSize	1.33m x 0.69m
Rotation	360°
SWL	200kg
Weight	1750kg
Outrigger Footprint	2.7m x 2.7m
Min Op Width	2.7m

Alternative machines

TB14HE
TB17HE
TB17HB

Manufacturer

Hinowa

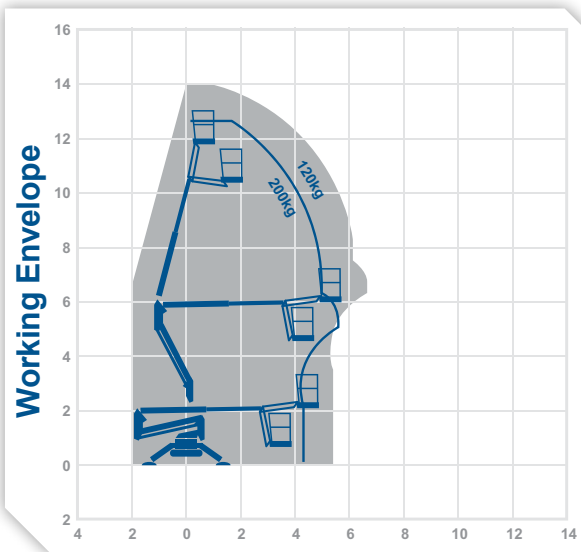

TB14HE

tracked
booms

Working Height 14.0m

Horizontal Outreach 7.0m

Closed Length	4.06m
Closed Height	1.99m
Rails Up / Fixed Rails	
Closed Width	0.78m
DeckSize	1.33m x 0.69m
Rotation	360°
SWL	200kg
Weight	1750kg
Outrigger Footprint	2.7m x 2.7m
Min Op Width	2.7m

Alternative machines

TB14HB
TB17HE
TB17HB

Manufacturer

Hinowa

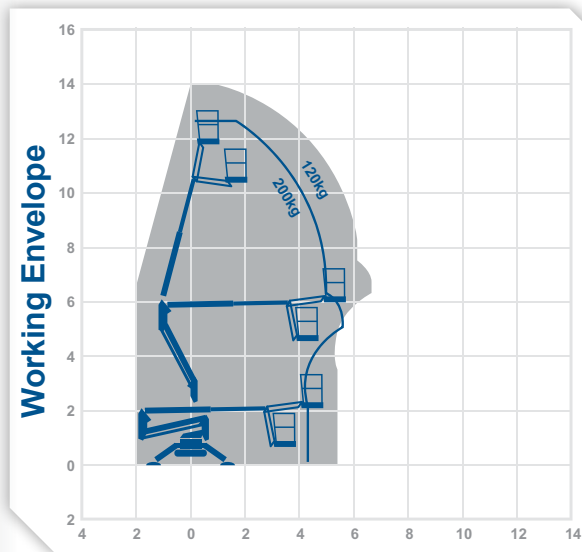

0345 745 0000
nationwideplatforms.co.uk



Nationwide Platforms
A Loxam Company

TB15HB

tracked
booms

Working Height 15.4m

Horizontal Outreach 6.6m

Closed Length	4.02m
Closed Height	1.99m
Rails Up / Fixed Rails	
Closed Width	0.75m
DeckSize	1.33m x 0.69m
Rotation	360°
SWL	230kg
Weight	1950kg
Outrigger Footprint	2.8m x 2.8m
Min Op Width	2.8m

Alternative machines

TB15HE
TB17HE
TB17HB

Manufacturer

Hinowa

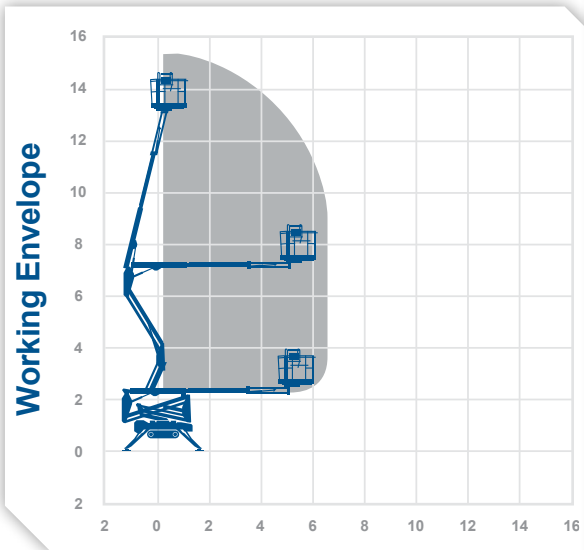

TB15HE

tracked
booms

Working Height 15.4m

Horizontal Outreach 6.6m

Closed Length	4.02m
Closed Height	1.99m
Rails Up / Fixed Rails	
Closed Width	0.75m
DeckSize	1.33m x 0.69m
Rotation	360°
SWL	230kg
Weight	1950kg
Outrigger Footprint	2.8m x 2.8m
Min Op Width	2.8m

Alternative machines

TB15HB
TB17HE
TB17HB

Manufacturer

Hinowa

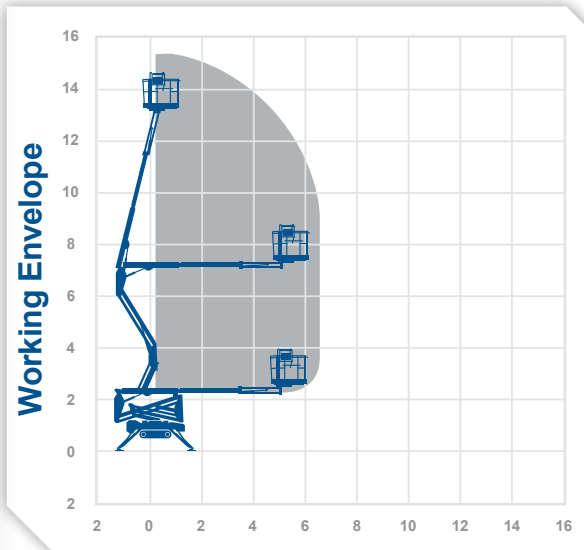

0345 745 0000
nationwideplatforms.co.uk



Nationwide Platforms
A **LOXAM** Company

TB17HB

tracked
booms

Working Height 17.06m

Horizontal Outreach 7.5m

Closed Length	4.52m
Closed Height Rails Up / Fixed Rails	2.0m
Closed Width	0.79m
DeckSize	1.33m x 0.69m
Rotation	360°
SWL	230kg
Weight	2280kg
Outrigger Footprint	2.88m x 2.89m
Min Op Width	2.88m

Alternative machines

TB17HE
TB20HE
TB20HB

Manufacturer

Hinowa

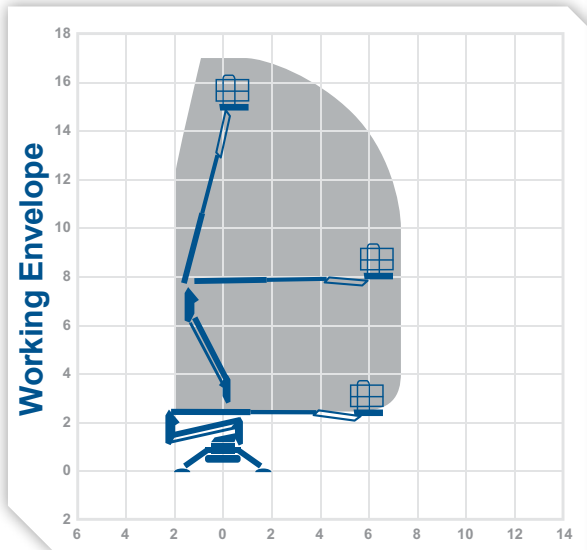

0345 745 0000
nationwideplatforms.co.uk



TB17HE

tracked
booms

Working Height 17.06m

Horizontal Outreach 7.5m

Closed Length	4.52m
Closed Height Rails Up / Fixed Rails	2.0m
Closed Width	0.79m
DeckSize	1.33m x 0.69m
Rotation	360°
SWL	230kg
Weight	2280kg
Outrigger Footprint	2.88m x 2.89m
Min Op Width	2.88m

Alternative machines

TB17HB
TB20HE
TB20HB

Manufacturer

Hinowa

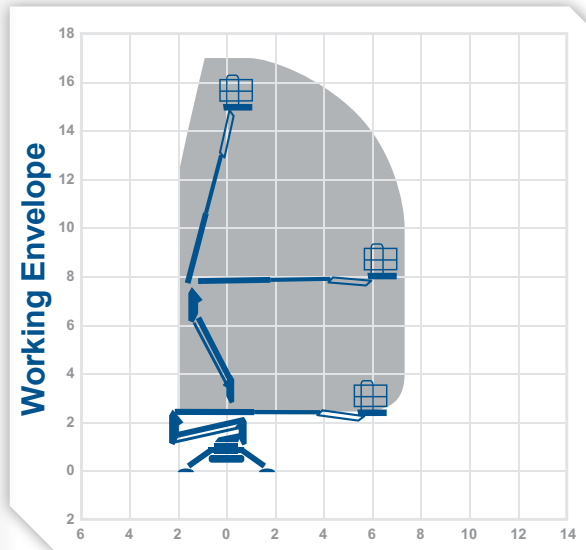

Nationwide Platforms
A **LOXAM** Company

TB18PB

tracked
booms

Working Height 17.6m

Horizontal Outreach 9.2m

Closed Length	5.21m
Closed Height	1.95m
Rails Up / Fixed Rails	
Closed Width	0.78m
DeckSize	1.3m x 0.7m
Rotation	360°
SWL	200kg
Weight	2350kg
Outrigger Footprint	3.1m x 3.1m
Min Op Width	3.1m

Alternative machines

TB17HE
TB20HE
TB20HB

Manufacturer

Hinowa

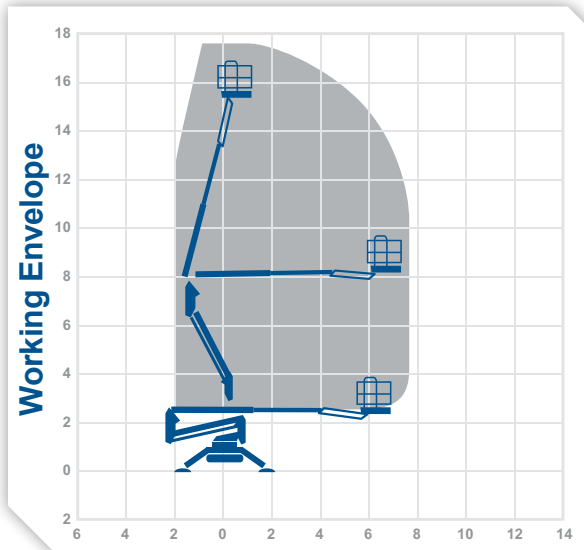

0345 745 0000
nationwideplatforms.co.uk



TB20HB

tracked
booms

Working Height 20.1m

Horizontal Outreach 9.7m

Closed Length	5.01m
Closed Height	1.99m
Rails Up / Fixed Rails	
Closed Width	0.79m
DeckSize	1.33m x 0.69m
Rotation	360°
SWL	230kg
Weight	2880kg
Outrigger Footprint	2.92m x 2.92m
Min Op Width	2.92m

Alternative machines

TB26HE
TB26HB
TB20HE

Manufacturer

Hinowa

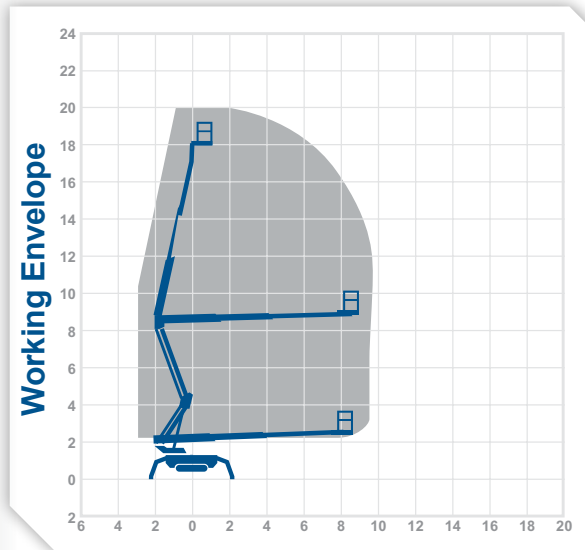

Nationwide Platforms
A **LOXAM** Company

TB20HE

tracked
booms

Working Height 20.1m

Horizontal Outreach 9.7m

Closed Length	5.01m
Closed Height	1.99m
Rails Up / Fixed Rails	
Closed Width	0.79m
DeckSize	1.33m x 0.69m
Rotation	360°
SWL	230kg
Weight	2880kg
Outrigger Footprint	2.92m x 2.92m
Min Op Width	2.92m

Alternative machines

TB26HE
TB26HB
TB17HB
TB20HB

Manufacturer

Hinowa

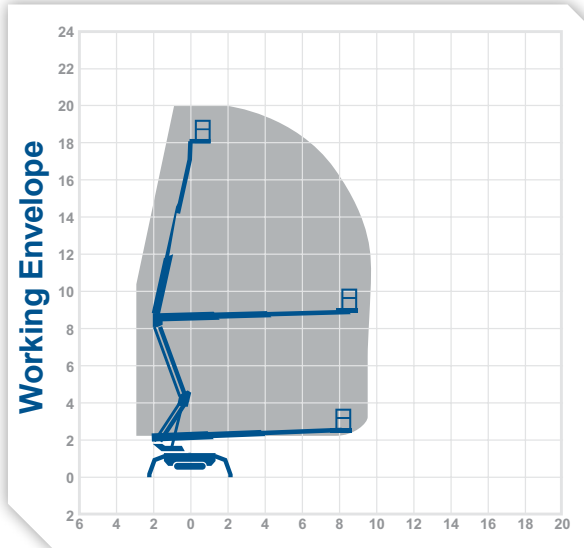

TB20JB

tracked
booms

Working Height 20.1m

Horizontal Outreach 9.7m

Closed Length	5.01m
Closed Height	1.99m
Rails Up / Fixed Rails	
Closed Width	0.79m
DeckSize	1.33m x 0.69m
Rotation	360°
SWL	230kg
Weight	2880kg
Outrigger Footprint	2.92m x 2.92m
Min Op Width	2.92m

Alternative machines

TB26HE
TB26HB
TB17HB
TB20HB

Manufacturer

Hinowa

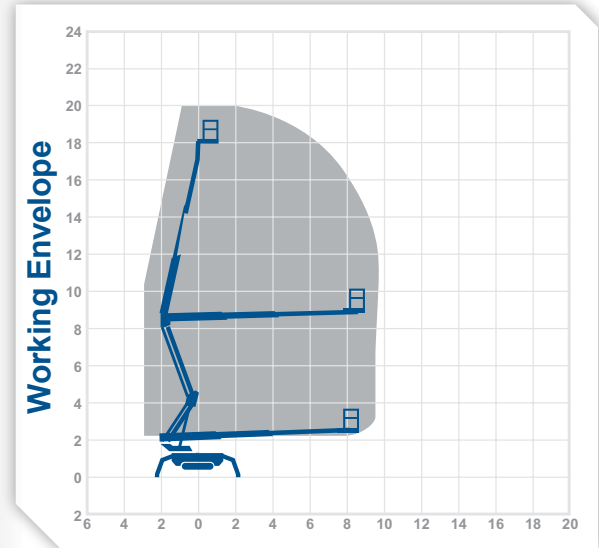

0345 745 0000
nationwideplatforms.co.uk



Nationwide Platforms
A **LOXAM** Company

TB26HB

tracked
booms

Working Height 25.7m

Horizontal Outreach 13.6m

Closed Length	6.34m
Closed Height	1.98m
Rails Up / Fixed Rails	
Closed Width	0.99m
DeckSize	1.33m x 0.69m
Rotation	360°
SWL	230kg
Weight	4415kg
Outrigger Footprint	4.07m x 3.97m
Min Op Width	3.97m

Alternative machines

TB26HE

Manufacturer

Hinowa

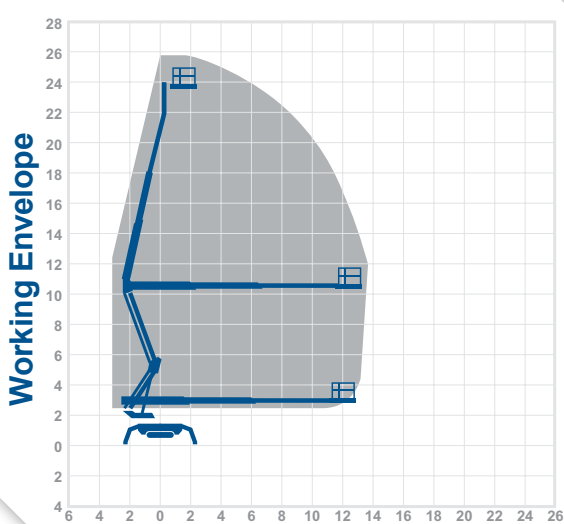

TB26HE

tracked
booms

Working Height 25.7m

Horizontal Outreach 13.6m

Closed Length	6.34m
Closed Height	1.98m
Rails Up / Fixed Rails	
Closed Width	0.99m
DeckSize	1.33m x 0.69m
Rotation	360°
SWL	230kg
Weight	4415kg
Outrigger Footprint	4.07m x 3.97m
Min Op Width	3.97m

Alternative machines

TB26HB

Manufacturer

Hinowa

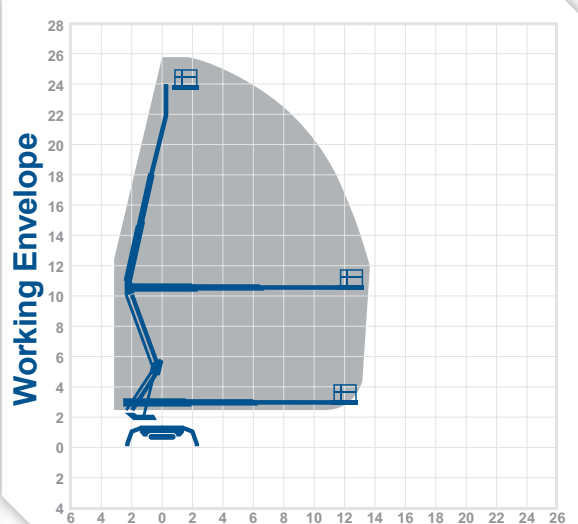

0345 745 0000
nationwideplatforms.co.uk



Nationwide Platforms
A **LOXAM** Company

TB30MB

tracked
booms

Working Height 30m
Horizontal Outreach 14m

Closed Length	6.65m
Closed Height	2.3m
Closed Width	1.6m
Platform Size	0.70m x 1.60m
Rotation	400°
Max SWL	270kg
Weight	5600kg
Min Op Width	3.3m

Alternative machines

TB31TB

Manufacturer

Multitel

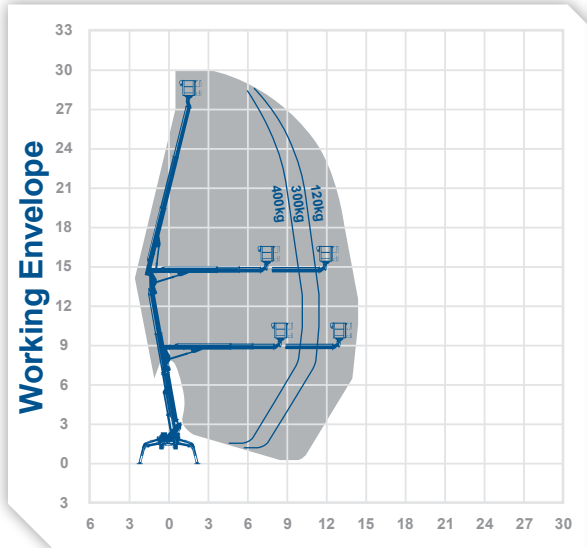

0345 745 0000
nationwideplatforms.co.uk



TB31TB

tracked
booms

Working Height 31.0m
Horizontal Outreach 14.7m

Closed Length	7.23m
Closed Height	1.98m
Rails Up / Fixed Rails	
Closed Width	1.58m
DeckSize	1.20m x 0.80m
Rotation	360°
SWL	250kg
Weight	4350kg
Outrigger Footprint	5.45m x 5.15m
Min Op Width	2.75m

Alternative machines

TB26HB
TB26HE

Manufacturer

Teupen

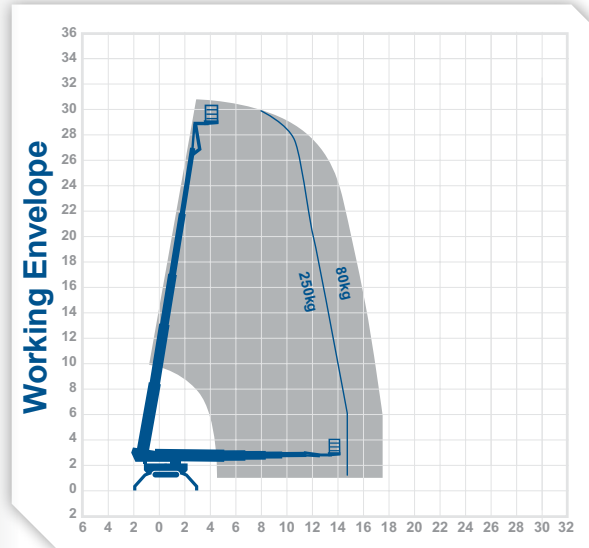

Nationwide Platforms
A **LOXAM** Company

Telehandlers



- Access to the UK's largest fleet of telehandlers
- Full range from compact 4m machines to 30m rotational telehandlers
- Rough terrain forklift
- Ideal for lifting heavy materials to height

Machine type by product code

JCB520-40	JCB535-140
JCB520-50	HTL4017
JCB525-60	JCB540-170
JCB531-70	JCB540-200
JCB3070	MRT2150
JCB926	ROTO6024
JCB533-105	MRT2540
JCB535-125	ROTO4026
HTL4014	ROTO4030



0345 745 0000
nationwideplatforms.co.uk



Nationwide Platforms
A **LOXAM** Company



Max Lift Height 4.0m
Max Forward Reach 2.59m

Manufacturer
 JCB

Overall Length 2.92m
 Overall Height 1.97m
 Overall Width 1.56m
 Max Capacity 2000kg
 Max Lift Capacity (full reach) 1000kg
 Weight 4400kg
 Outside Turn Radius 3.05m

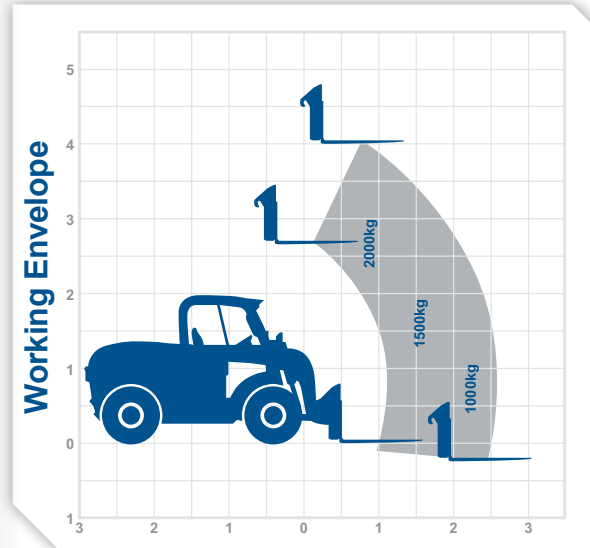

0345 745 0000
nationwideplatforms.co.uk



Nationwide Platforms
 A **LOXAM** Company

2.59m 4.0m

JCB520-50

telehandlers

Max Lift Height 5.0m
Max Forward Reach 2.82m

Overall Length 3.08m
 Overall Height 2.12m
 Overall Width 1.84m
 Max Capacity 2000kg
 Max Lift Capacity (full reach) 750kg
 Weight 4870kg
 Outside Turn Radius 3.1m

Manufacturer
 JCB

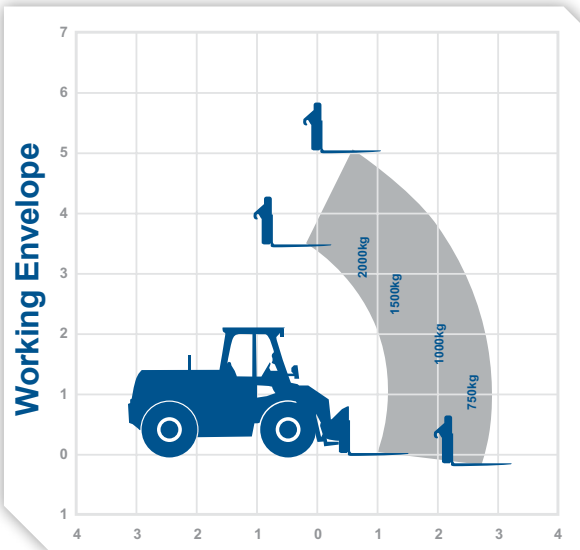

0345 745 0000
nationwideplatforms.co.uk



JCB525-60

telehandlers

Max Lift Height 6.0m
Max Forward Reach 3.06m

Overall Length 3.38m
 Overall Height 1.89m
 Overall Width 1.84m
 Max Capacity 2500kg
 Max Lift Capacity (full reach) 1750kg
 Weight 5490kg
 Outside Turn Radius 3.71m

Manufacturer
 JCB

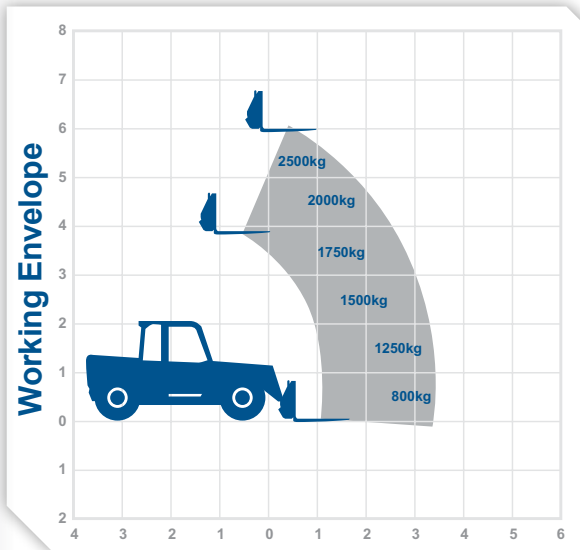

Nationwide Platforms
 A **LOXAM** Company

JCB531-70

telehandlers

Max Lift Height 7.0m
Max Forward Reach 3.7m

Overall Length 4.38m
 Overall Height 2.49m
 Overall Width 2.23m
 Max Capacity 3500kg
 Max Lift Capacity (full reach) 2400kg
 Weight 7060kg
 Outside Turn Radius 3.7m

Manufacturer
 JCB

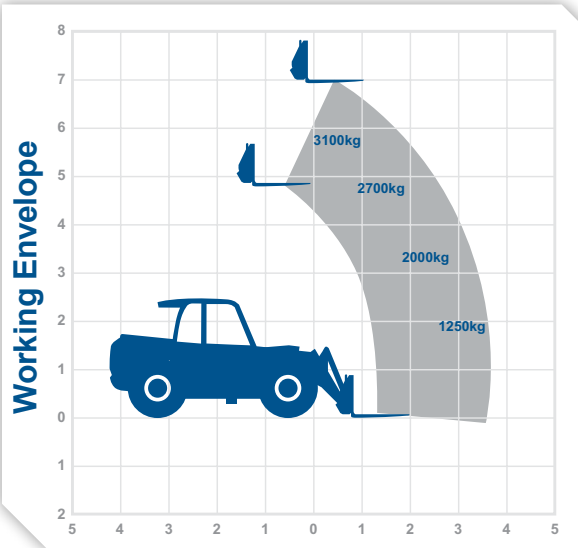

0345 745 0000
nationwideplatforms.co.uk

JCB3070

telehandlers

Max Lift Height 7.0m
Max Forward Reach 3.7m

Overall Length 4.99m
 Overall Height 2.49m
 Overall Width 2.23m
 Max Capacity 3000kg
 Max Lift Capacity (full reach) 1250kg
 Weight 6900kg
 Outside Turn Radius 3.7m

Manufacturer
 JCB

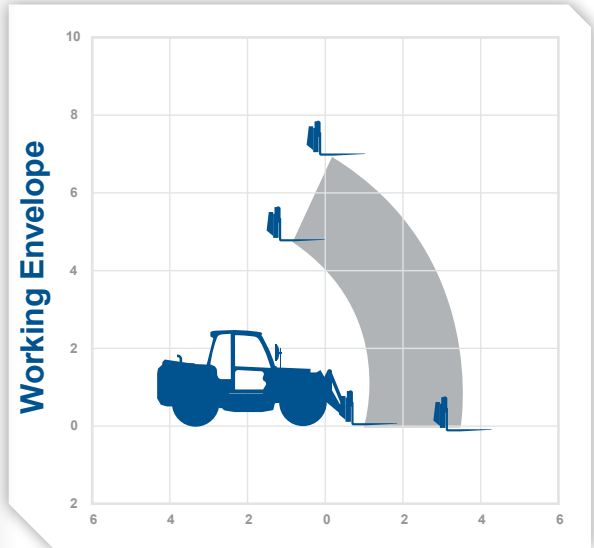

Nationwide Platforms
 A **LOXAM** Company



Max Lift Height 7.67m
Max Forward Reach N/A

Overall Length 3.6m
 Overall Height 2.57m
 Overall Width 2.2m
 Max Capacity 3000kg
 Max Lift Capacity (full reach) 2600kg
 Weight 5910kg
 Outside Turn Radius 4.49m

Manufacturer
 JCB

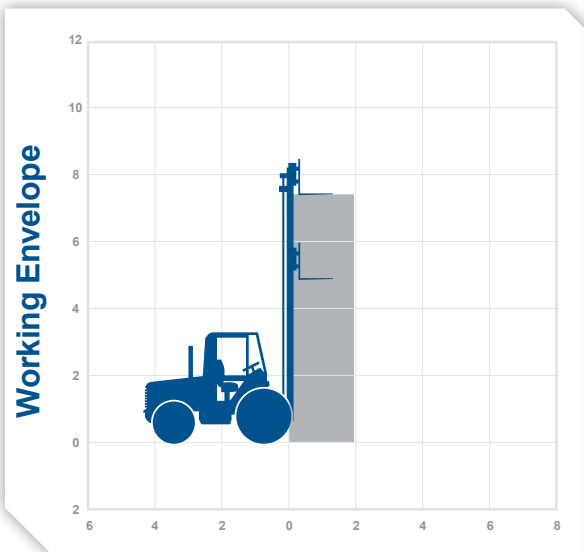

0345 745 0000
nationwideplatforms.co.uk

Max Lift Height 10.2m
Max Forward Reach 6.83m

Overall Length 4.38m
 Overall Height 2.49m
 Overall Width 2.29m
 Max Capacity 3300kg
 Max Lift Capacity (full reach) 1000kg
 Weight 8850kg
 Outside Turn Radius 3.7m

Manufacturer
 JCB

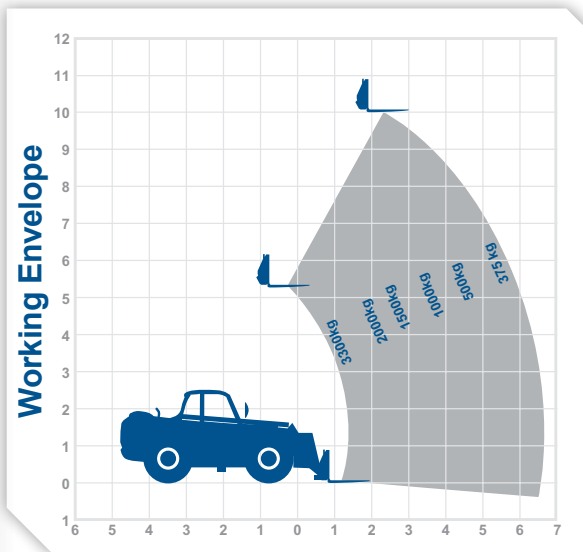

Nationwide Platforms
 A **LOXAM** Company



Max Lift Height 12.28m
Max Forward Reach 8.1m

Overall Length 5.8m
 Overall Height 2.59m
 Overall Width 2.35m
 Max Capacity 3500kg
 Max Lift Capacity (full reach) 1150kg
 Weight 10066kg
 Outside Turn Radius 3.75m

Manufacturer
 JCB

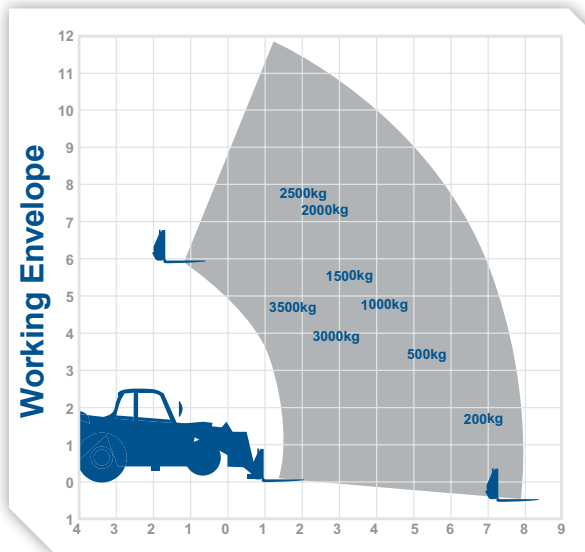

0345 745 0000
nationwideplatforms.co.uk



Max Lift Height 13.6m
Max Forward Reach 9.8m

Overall Length 6.46m
 Overall Height 2.6m
 Overall Width 2.43m
 Max Capacity 4000kg
 Max Lift Capacity (full reach) 1000kg
 Weight 10710kg
 Outside Turn Radius 4.5m

Manufacturer
 Haulotte

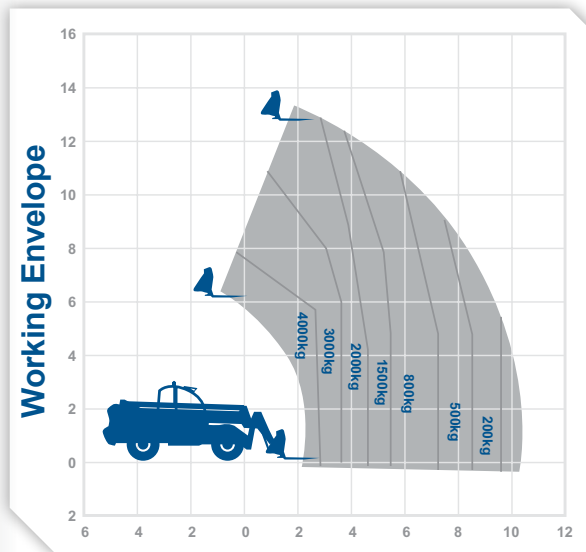

Nationwide Platforms
 A **LOXAM** Company

Max Lift Height 13.78m
Max Forward Reach 9.7m

Overall Length 6.23m
 Overall Height 2.59m
 Overall Width 2.35m
 Max Capacity 3500kg
 Max Lift Capacity (full reach) 1250kg
 Weight 11090kg
 Outside Turn Radius 4.1m

Manufacturer
 JCB

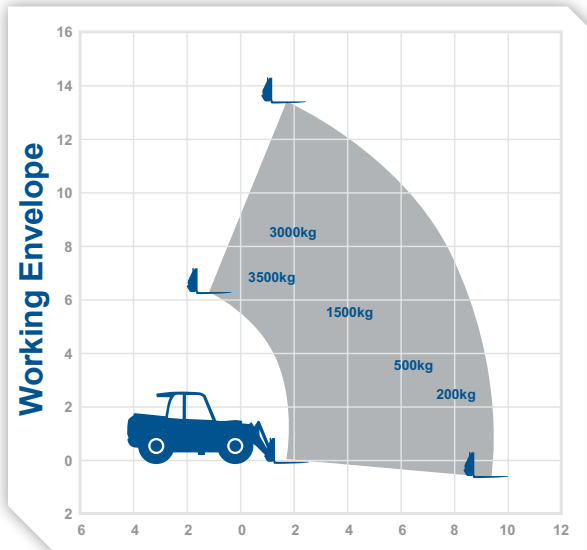

0345 745 0000
nationwideplatforms.co.uk



Max Lift Height 16.7m
Max Forward Reach 12.9m

Overall Length 6.65m
 Overall Height 2.6m
 Overall Width 2.43m
 Max Capacity 4000kg
 Max Lift Capacity (full reach) 700kg
 Weight 12000kg
 Outside Turn Radius 4.5m

Manufacturer
 Haulotte

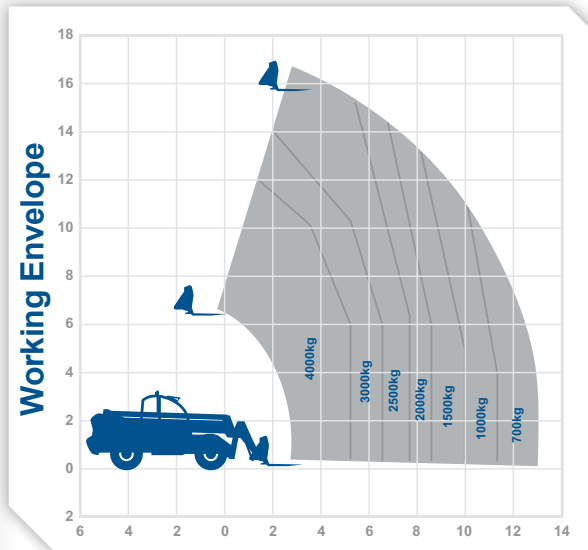

Nationwide Platforms
 A **LOXAM** Company

JCB540-170

telehandlers

Max Lift Height 16.7m
Max Forward Reach 12.5m

Overall Length 6.36m
Overall Height 2.69m
Overall Width 2.44m
Max Capacity 4000kg
Max Lift Capacity (full reach) 2500kg
Weight 12060kg
Outside Turn Radius 4.1m

Manufacturer
JCB



16.7m
12.5m

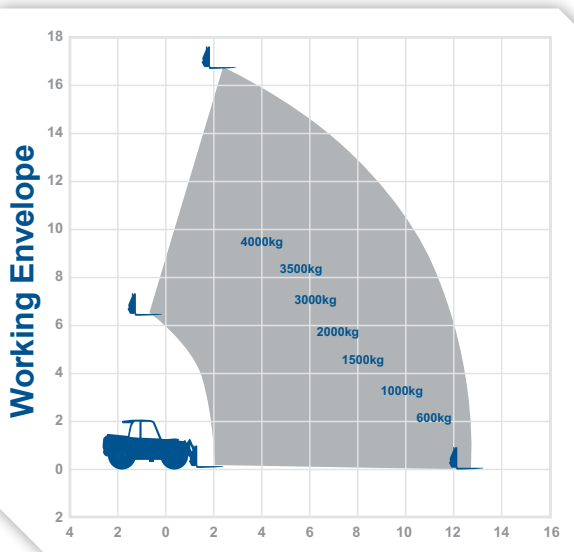

0345 745 0000
nationwideplatforms.co.uk



JCB540-200

telehandlers

Max Lift Height 20.0m
Max Forward Reach 15.9m

Overall Length 6.81m
Overall Height 2.72m
Overall Width 2.44m
Max Capacity 4000kg
Max Lift Capacity (full reach) 200kg
Weight 12985kg
Outside Turn Radius 4.1m

Manufacturer
JCB



20.0m
15.9m

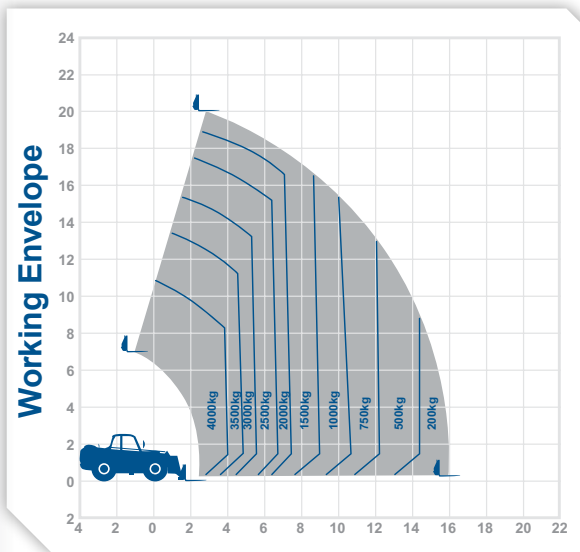

Nationwide Platforms
A Loxam Company

MRT2150

telehandlers

Max Lift Height 20.6m

Max Forward Reach 18.1m

Overall Length	6.78m
Overall Height	3.05m
Overall Width	2.43m
Max Capacity	4999kg
Max Lift Capacity (full reach)	600kg
Weight	16095kg
Outside Turn Radius	4.04m

Manufacturer
Manitou

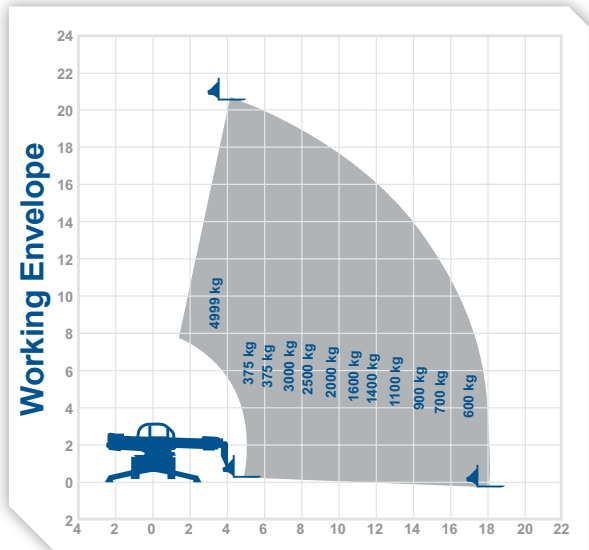

0345 745 0000
nationwideplatforms.co.uk



ROTO6024

telehandlers

Max Lift Height 23.9m

Max Forward Reach 20.8m

Overall Length	7.43m
Overall Height	3.1m
Overall Width	2.49m
Max Capacity	6000kg
Max Lift Capacity (full reach)	850kg
Weight	18750kg
Outside Turn Radius	6.5m

Manufacturer
Merlo

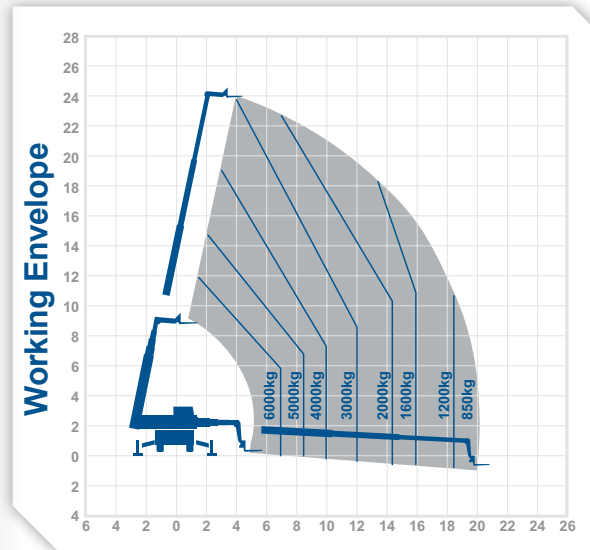

Nationwide Platforms
A Loxam Company

20.6m
18.0m

23.9m
20.8m

MRT2540

telehandlers

Max Lift Height 24.6m

Max Forward Reach 18.5m

Overall Length	7.82m
Overall Height	3.05m
Overall Width	2.43m
Max Capacity	4000kg
Max Lift Capacity (full reach)	400kg
Weight	17165kg
Outside Turn Radius	4.04m

Manufacturer
Manitou

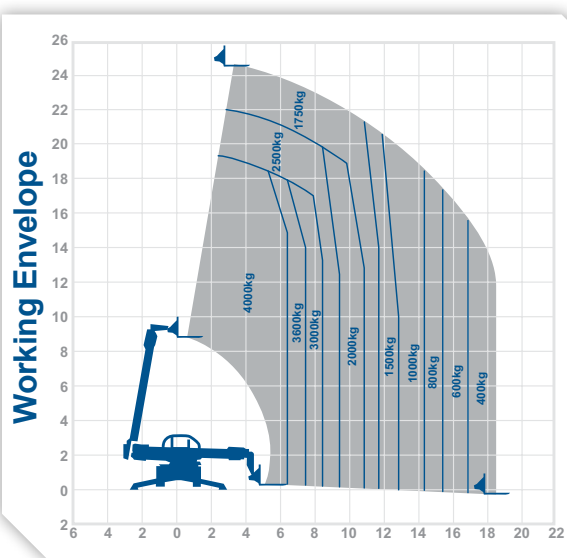

0345 745 0000
nationwideplatforms.co.uk



ROTO4026

telehandlers

Max Lift Height 26.0m

Max Forward Reach 22.9m

Overall Length	6.98m
Overall Height	2.95m
Overall Width	2.4m
Max Capacity	4000kg
Max Lift Capacity (full reach)	150kg
Weight	16050kg
Outside Turn Radius	6.85m

Manufacturer
Merlo

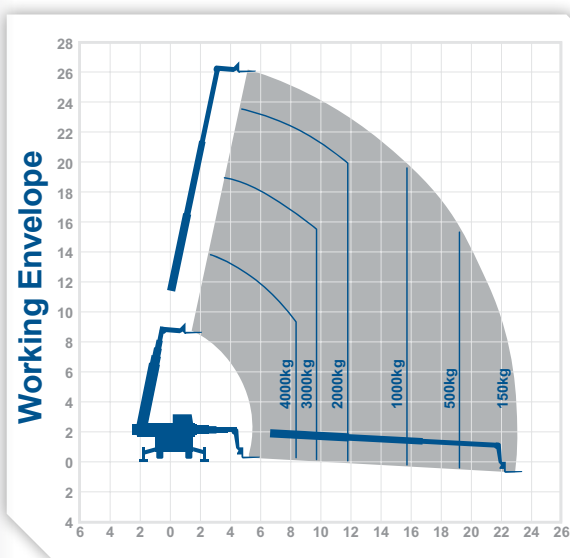

Nationwide Platforms
A Loxam Company

Max Lift Height 29.5m
Max Forward Reach 25.5m

Overall Length 7.56m
 Overall Height 3.1m
 Overall Width 2.49m
 Max Capacity 4000kg
 Max Lift Capacity (full reach) 400kg
 Weight 19200kg
 Outside Turn Radius 6.7m

Manufacturer
 Merlo



RT⁴

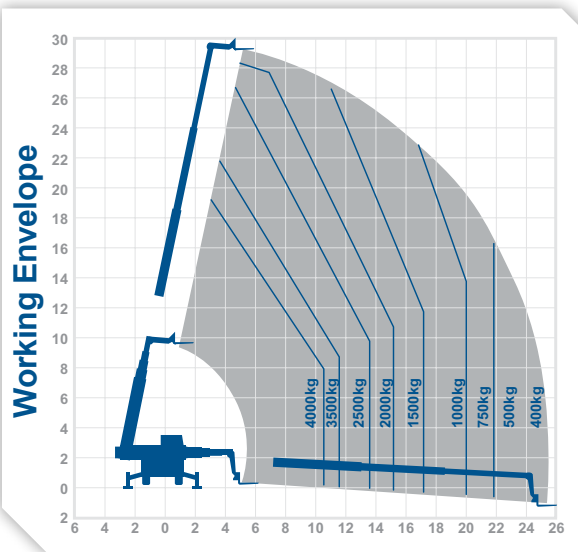

0345 745 0000
nationwideplatforms.co.uk



Nationwide Platforms
 A **LOXAM** Company

Safety Solutions, Attachments & Accessories



Safety and Productivity Innovation

Available exclusively through Nationwide Platforms, our BlueSky innovations can help bring new levels of productivity and safety to your project.

- Available to hire and pre-fitted with all applicable Nationwide Platforms equipment
- Enables users to conform to contractor specific mandates surrounding key safety issues
- Material handling solutions designed to boost efficiencies and convenience whilst tackling risks associated with manual handling
- For bespoke solutions please speak to your account manager

Machine type by product code

Solo-Gyps	SkyScreen™
SkySiren®	SkyRak Edge™
SkySiren® PCS™	SkyTel
SkySentry™	SkyRakTether™
SkyRak®	SkyShield
SkyRakPlus®	Accessories
SkyRakBoom®	

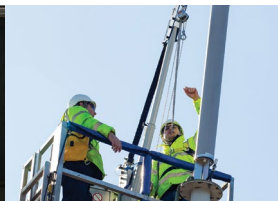

0345 745 0000
nationwideplatforms.co.uk



Nationwide Platforms
A **LOXAM** Company

Nationwide Platforms can now offer the UK's first drywall MEWP attachment. Solo-Gyps has been designed solely for use with the 4.9m Leonardo HD low level access platform. Featuring a motorised track, Solo-Gyps enables the simpler positioning of plasterboard ceiling panels, saving manpower and effectively allowing one operator to lift panels without assistance. This is ideal for interior fit-out projects.

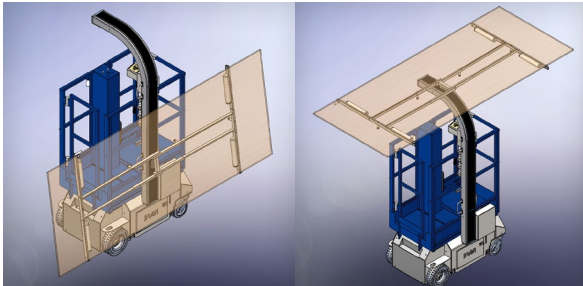

- To be used on the 4.9m Leonardo HD low level access platform only
- Three different height positions to clear even the tallest operator
- Allows one person to lift panels up to 40kg without assistance thus reducing manual handling
- Increases productivity as operators are able to fit more ceiling panels in one day
- Attachment is suitable for indoor use only

0345 745 0000
nationwideplatforms.co.uk



Nationwide Platforms
A **LOXAM** Company

Nationwide Platforms' Secondary Guarding solution is the pioneering SkySiren®; designed to reduce the risks associated with entrapment. Not only does it stop the MEWP when an entrapment situation is detected, to prevent further crushing, it also has a flashing light and emergency klaxon to attract the attention of colleagues on the ground to enact the emergency lowering procedure without delay.



The unique pressure sensitive system, acts as an 'emergency switch' in an entrapment situation. It is designed to react to the body pressure of an operator trapped against the boom lift's control panel.

The SkySiren® is a CE Certified retro-fit system capable of being fitted to most boom-type MEWPs.



Look for the SkySiren® icon to identify which machines can benefit from this unique attachment.

In addition to the pioneering SkySiren® Nationwide Platforms have introduced the next level in safe operating at height with SkySiren®PCS™. Working in concert with SkySiren®, the SkySiren®PCS™ attachment uses proximity sensing technology to help avoid entrapment situation occurring.



The continuous operation of proximity sensors built into the the SkySiren®PCS™ provides a sensing 'zone of protection', alerting the operator to potential hazards before they occur. The system has been designated as Intelligent Secondary Guarding.

The award winning design provides maximum protection, while at the same time not impeding either the MEWP's functionality nor the operators ability to carry out tasks. The SkySiren®PCS™ is CE Certified retro fit system capable of being fitted to most boom and scissor type MEWPs.



Look for the SkySiren®PCS™ icon to identify which machines can benefit from this unique attachment.

SkySentry™ is a simple and effective fleet management system designed to help you reduce costs, drive efficiency and improve safety.



SkySentry™ is a full service system designed to improve the management of your powered access fleet across multiple sites and safeguard against unauthorised use.

The system offers unrivalled access and visibility of not only who is operating a machine at any one time. But also if they are correctly trained and authorised to do so.



Look for the SkySentry™ icon to identify which machines can benefit from this feature.

Fits most small electric scissor lifts to enable the fast and safe installation of materials up to 150kg (300kg if fitted as double and MEWP capacity allows). Materials are securely fastened using the straps provided.

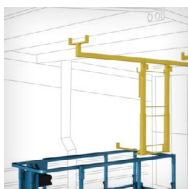

The unique design of the SkyRak® means the load weight is transferred to the platform floor, avoiding materials being rested on the non-load bearing hand-rails.

SkyRak® fits most small electric scissor lifts to enable the fast and safe installation of materials at height.



Look for the SkyRak® icon to identify which machines can benefit from this unique attachment.

SkyRakPlus® allows materials up to 600kg to be safely stored on most large decked diesel scissor lifts, with no weight put on the MEWP handrail.

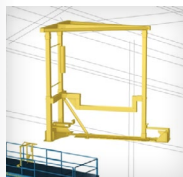
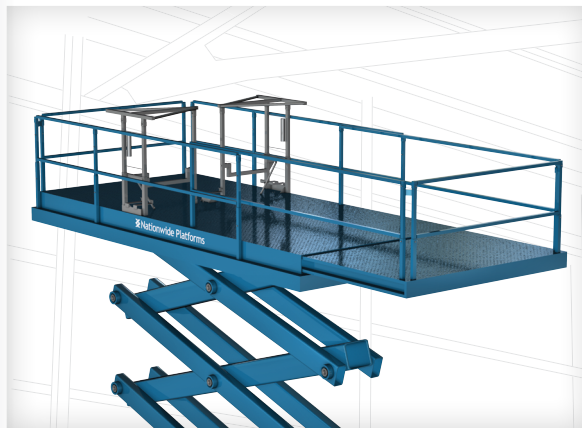

A system of flexible heads support a wide variety of materials of many shapes and sizes including pipes, ducting, cladding, steelwork and bus bars.

When the MEWP is in motion, the materials are secured by use of moveable pins and straps.



Look for the SkyRakPlus® icon to identify which machines can benefit from this unique attachment.

SkyRakBoom® allows the safe storage of materials up to 90kg in weight. Materials are stored with no weight on the MEWP's handrails.

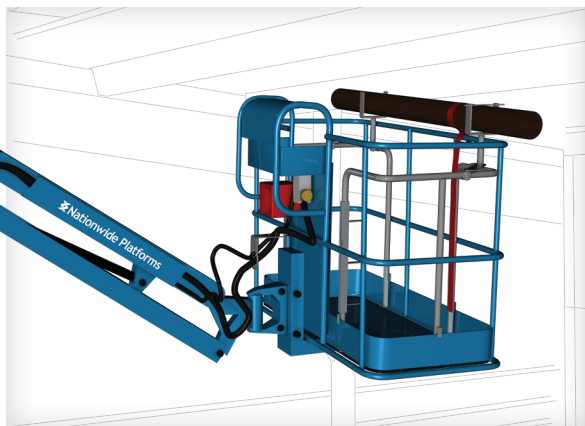

Whilst the boom is in operation, materials are safely secured using the straps provided which significantly reduces the risk of materials falling to the ground.

SkyRakBoom® is suitable for installation to all standard Genie 6ft and 8ft 'boom-type' baskets.



Look for the SkyRakBoom® icon to identify which machines can benefit from this unique attachment.

Available on the majority of our boom lifts, SkyScreen™ reduces the risk of items failing from the platform basket while also offering added protection to personnel and machines on the ground.



Velcro and magnetised fittings allow operators to assemble and remove quickly and efficiently and its design allows all normal cage operations to be unaffected. Additional features include being fire retardant and wind resistant up to 6m/s.



Look for the SkyScreen™ icon to identify which machines can benefit from this unique attachment.

SkyRakEdge™ is a lightweight material handling attachment designed to safely and securely handle scaffold tubes or lattice and ladder edge protection beams on boom type Mobile Elevated Work Platforms (MEWPs).

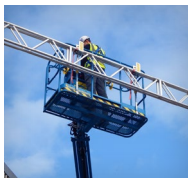
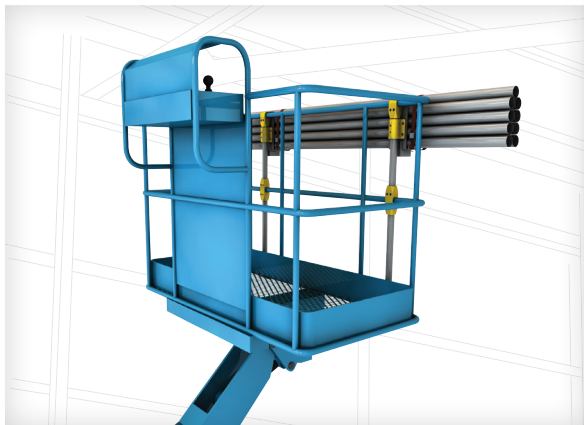

SkyRakEdge™ securely holds up to 9 x scaffold tube 6m length, or 2 x 6m lattice beams, or 1 x 8m lattice beam*

It reduces the risk of materials falling from height and removes excess tube weight on the handrails

* Subject to maximum payload



Look for the SkyRakEdge™ icon to identify which machines can benefit from this unique attachment.

SkyTel from Nationwide Platforms is the latest innovation in safety and efficiency, reducing the need for the manual handling of antennas in the telecoms sector.

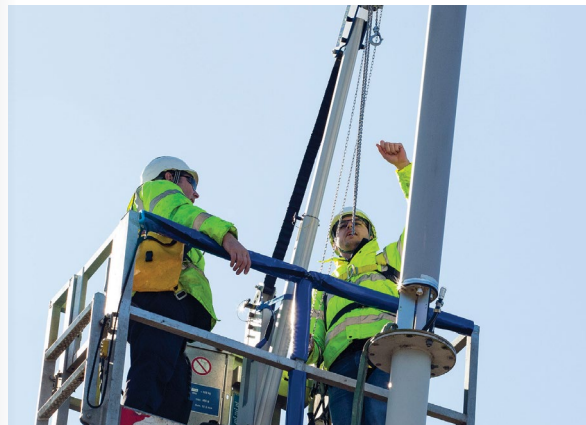

Provides a consistent, safe method of work for the installation and removal of antennas. Easily installed and removed in minutes.



Look for the SkyTel icon to identify which machines can benefit from this unique attachment.

SkyRakTether™, the lightweight tested tethering post for Mobile Elevating Work Platforms utilises a bespoke tethering bag providing safe storage for all tethered tools allowing operators to work freely at height and reducing the risk associated with items falling from height.

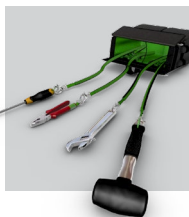

- Reduces the risk of tools falling from height
- Safe tool storage when not in use
- Improves productivity
- Complies with many Tier One company's tethering policies
- Complies with HSE guidance

Compatible with a wide range of booms and scissors type MEWPs.

SkyShield is a robust, lightweight screen providing maximum visibility and offers a safer working environment helping to provide COVID-19 protection

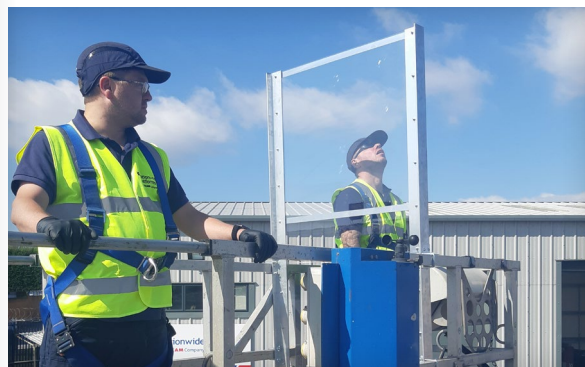

The lightweight aluminium frame holds a UV stable shatterproof polycarbonate barrier requires no tools to fit.

SkyShield is wind rated compliant and compatible with a range of vehicle mounted booms platforms including: GSR 22m, Ruthmann 28m (4x4) & 33m Bronto 38m, 50m, 56m, 70m, 90m – all with extending basket to 3.7m



Look for the SkyShield icon to identify which machines can benefit from this unique attachment.

Harness and Lanyards

IPAF strongly recommends that a full body harness with an adjustable lanyard (used to provide work restraint and adjusted to be as short as possible) is used when working from a boom type MEWP or vehicle mounted boom.

For more information from IPAF and details of their 'Clunk Click' harness campaign visit www.ipaf.org.

Harness and lanyards sets are available to purchase at the time of hire.

Wheel Covers and Nappies

Most electric machines are fitted with non-marking tyres, designed to minimise the risk of damaging finished floors. These machines are easily identified by the non-marking tyre icon at the top of each page in the machine specification section of this brochure.

If a machine without non-marking tyres is required for work on a finished floor, wheel covers can be fitted to protect the flooring.

Lighting Frames and Camera Cages

Nationwide Platforms offers a variety of machines suitable for mounting lighting equipment and cameras, making them ideal for broadcast, cinema and other media applications.



For easy reference look out for the icons to identify which machines can be fitted with optional extras designed for media and broadcasting applications.

Key Pads

Key pads can be fitted to machines to minimise theft, unauthorised use of the machine and downtime caused by unscheduled equipment use. The key pads are programmable and weatherproof. Simply request a key pad when you place your order.

Pre-use Inspection Cards

Are your operators complying with the law each time they use powered access machines?

Regulations state that pre-use checks must be made before any operator uses an access platform, with users also required to make a record.

Our daily inspection cards have been designed to help powered access users conform to the law by acting as a comprehensive checklist and record of machine use.

Daily inspection sheets are now available to order with all hires.

Daily Machine Inspections

All of our powered access platforms are subject to extensive safety maintenance checks before they reach you. For extra peace of mind when machines are on your site for longer periods of work, we can also organise daily inspections by a qualified engineer from your local depot.

Please call today and ask for details on our pre-use inspection cards.

0345 745 0000
nationwideplatforms.co.uk



 **Nationwide Platforms**
A **LOXAM** Company

Power to Platform

Most machines are fitted with a 110v socket at ground level that can be connected to your power source. Power is fed through an internal lead within the machine structure to the platform socket. Using this feature ensures that extension cables do not become trapped in the machine or dangle over buildings and other workers.



For easy reference look out for the icon to identify which machines have power to platform.

Onboard Generators

Many diesel powered machines also have an onboard generator which removes the need to hire a separate generator or have leads trailing from the machine across the workplace. Please request an onboard generator when ordering your machine.



Look out for the icon to identify the machines which can be hired with on board generators.

Chalwyn Valves

Chalwyn valves can be attached to a diesel engine air intake system. The valve is designed to safely shutdown the engine in the event of external vapours or gasses being sucked into the engine through the air intake.

In areas where there is a chance of vapour ignition a chalwyn valve will normally be specified by the site owner. Typical uses are in petrochemical plants and refineries including refurbishment of petrol station forecourts.

The valve can be fitted to all diesel scissor and boom lifts.

Please note: a minimum of 48 hours notice is required to fit the chalwyn valve.

Spark Arrestors

Spark arrestors are attached to the exhaust system of diesel machines to eliminate sparks from exiting the exhaust. Spark arrestors are usually specified by the site contractor or operator and are typically required on petrol station refurbishments, petrochemical plant works and refineries. Spark arrestors can be fitted on request, but must be fitted before the machine reaches site.

Please note: a minimum of 48 hours notice is required prior to delivery.

Earth Bonding

Nationwide Platforms has the UK's largest fleet of boom lifts fitted with earth straps that conform to National Grid specification. This continual safety link running from the platform to the ground safely deflects electric currents, protecting both the machine and its operator from electrocution.

Many site operators request earth bonding if the machine is to be used near live electrical apparatus in locations such as sub stations, power stations and live overhead cables.

Please remember to inform us at the time of booking if you require earth bonding on your machine.

Weight Conversion

Distance Conversion

Metric to Imperial (kg x 2.2046 = lbs)			
kg	lbs	kg	lbs
500	- 1,102	27,000	- 59,524
1,000	- 2,204	27,500	- 60,627
1,500	- 3,306	28,000	- 61,729
2,000	- 4,409	28,500	- 62,831
2,500	- 5,511	29,000	- 63,933
3,000	- 6,613	29,500	- 65,036
3,500	- 7,716	30,000	- 66,138
4,000	- 8,818	30,500	- 67,240
4,500	- 9,920	31,000	- 68,343
5,000	- 11,023	31,500	- 69,445
5,500	- 12,125	32,000	- 70,547
6,000	- 13,227	32,500	- 71,650
6,500	- 14,330	33,000	- 72,752
7,000	- 15,432	33,500	- 73,854
7,500	- 16,534	34,000	- 74,957
8,000	- 17,636	34,500	- 76,059
8,500	- 18,739	35,000	- 77,161
9,000	- 19,841	35,500	- 78,264
9,500	- 20,943	36,000	- 79,366
10,000	- 22,046	36,500	- 80,468
10,500	- 23,148	37,000	- 81,570
11,000	- 24,250	37,500	- 82,673
11,500	- 25,353	38,000	- 83,775
12,000	- 26,455	38,500	- 84,877
12,500	- 27,557	39,000	- 85,980
13,000	- 28,660	39,500	- 87,082
13,500	- 29,762	40,000	- 88,184
14,000	- 30,864	40,500	- 89,287
14,500	- 31,966	41,000	- 90,389
15,000	- 33,069	41,500	- 91,491
15,500	- 34,171	42,000	- 92,594
16,000	- 35,273	42,500	- 93,696
16,500	- 36,376	43,000	- 94,798
17,000	- 37,478	43,500	- 95,900
17,500	- 38,580	44,000	- 97,003
18,000	- 39,683	44,500	- 98,105
18,500	- 40,785	45,000	- 99,207
19,000	- 41,887	45,500	- 100,310
19,500	- 42,990	46,000	- 101,412
20,000	- 44,092	46,500	- 102,514
20,500	- 45,194	47,000	- 103,617
21,000	- 46,297	47,500	- 104,719
21,500	- 47,399	48,000	- 105,821
22,000	- 48,501	48,500	- 106,924
22,500	- 49,603	49,000	- 108,026
23,000	- 50,706	49,500	- 109,128
23,500	- 51,808	50,000	- 110,231
24,000	- 52,910	50,500	- 111,333
24,500	- 54,013	51,000	- 112,435
25,000	- 55,115	51,500	- 113,537
25,500	- 56,217	52,000	- 114,640
26,000	- 57,320	52,500	- 115,742
26,500	- 58,422	53,000	- 116,844

Imperial to Metric (lbs x 0.4536 = kg)			
lbs	kg	lbs	kg
54,000	- 24,493		
55,000	- 24,947		
56,000	- 25,401		
57,000	- 25,854		
58,000	- 26,308		
59,000	- 26,761		
60,000	- 27,215		
61,000	- 27,669		
62,000	- 28,122		
63,000	- 28,576		
64,000	- 29,029		
65,000	- 29,483		
66,000	- 29,937		
67,000	- 30,390		
68,000	- 30,844		
69,000	- 31,297		
70,000	- 31,751		
71,000	- 32,205		
72,000	- 32,658		
73,000	- 33,112		
74,000	- 33,565		
75,000	- 34,019		
76,000	- 34,472		
77,000	- 34,926		
78,000	- 35,380		
79,000	- 35,833		
80,000	- 36,287		
81,000	- 36,740		
82,000	- 37,194		
83,000	- 37,648		
84,000	- 38,101		
85,000	- 38,555		
86,000	- 39,008		
87,000	- 39,462		
88,000	- 39,916		
89,000	- 40,369		
90,000	- 40,823		
91,000	- 41,276		
92,000	- 41,730		
93,000	- 42,184		
94,000	- 42,637		
95,000	- 43,091		
96,000	- 43,544		
97,000	- 43,998		
98,000	- 44,452		
99,000	- 44,905		
100,000	- 45,359		
101,000	- 45,812		
102,000	- 46,266		
103,000	- 46,719		
104,000	- 47,173		
105,000	- 47,626		
106,000	- 48,081		

Metric to Imperial (m x 3.2808 = ft)			
m	ft	m	ft
6.0	- 19' 8"		
6.5	- 21' 4"		
7.0	- 23' 0"		
7.5	- 24' 7"		
8.0	- 26' 4"		
8.5	- 27' 11"		
9.0	- 29' 4"		
9.5	- 31' 2"		
10.0	- 32' 10"		
10.5	- 34' 6"		
11.0	- 36' 1"		
11.5	- 37' 10"		
12.0	- 39' 5"		
12.5	- 41' 0"		
13.0	- 42' 8"		
13.5	- 44' 3"		
14.0	- 45' 11"		
14.5	- 47' 7"		
15.0	- 49' 2"		
15.5	- 50' 10"		
16.0	- 52' 6"		
16.5	- 54' 1"		
17.0	- 55' 9"		
17.5	- 57' 5"		
18.0	- 59' 1"		
18.5	- 60' 8"		
19.0	- 62' 3"		
19.5	- 63' 11"		
20.0	- 65' 7"		
20.5	- 67' 3"		
21.0	- 68' 11"		
21.5	- 70' 7"		
22.0	- 72' 2"		
22.5	- 73' 9"		
23.0	- 75' 6"		
23.5	- 77' 1"		
24.0	- 78' 9"		
24.5	- 80' 4"		
25.0	- 82' 0"		
25.5	- 83' 7"		
26.0	- 85' 3"		
26.5	- 86' 11"		
27.0	- 88' 7"		
27.5	- 90' 3"		
28.0	- 91' 9"		
28.5	- 93' 6"		
29.0	- 95' 1"		
29.5	- 96' 9"		
30.0	- 98' 4"		
30.5	- 100' 1"		
31.0	- 101' 10"		
31.5	- 103' 5"		
32.0	- 105' 0"		
32.5	- 106' 8"		
33.0	- 108' 3"		
33.5	- 109' 11"		
34.0	- 111' 7"		
34.5	- 113' 2"		
35.0	- 114' 10"		
35.5	- 116' 6"		
36.0	- 118' 1"		
36.5	- 119' 9"		
37.0	- 121' 5"		
37.5	- 123' 0"		
38.0	- 124' 8"		
38.5	- 126' 4"		
39.0	- 127' 11"		

Imperial to Metric (ft x 0.3048 = m)	
ft	m
4.57	
6.10	
7.62	
9.14	
10.67	
12.19	
13.72	
15.24	
16.76	
18.29	
19.81	
21.34	
22.86	
24.38	
25.91	
27.43	
28.96	
30.48	
32.00	
33.53	
35.05	
36.58	
38.10	
39.62	
41.15	
42.67	
44.20	
45.72	
47.24	
48.77	
50.29	
51.82	
53.34	
54.86	
56.39	
57.91	
59.44	
60.96	
62.48	
64.01	
65.53	
67.06	
68.58	
70.10	
71.63	
73.15	
74.68	
76.20	
77.72	
79.24	
80.77	
82.30	
83.82	



PLEASE NOTE:

All technical information referred to in this document is intended for guidance purposes only and does not act as a replacement for the full manufacturer specification or equipment user guides.

All information provided is subject to alteration and amendment without prior notice. Please contact Nationwide Platforms for confirmation of machine performance and specification when placing your order.