



# Powered Access Selection Guide



# Welcome to our powered access selection guide. Inside you'll find all the information you need to begin working safely and effectively at height.

To get you started we've included comprehensive guidance on our leading product range, as well as advice on the accessories, innovations and training that'll help you succeed on your next task or project.

Remember, if you want to get in touch with us at any point whilst you're browsing, you can give us a call with any enquiries, feedback or hire requests.

Back to start of section (scissors)

4626	scissors	6826D	scissors
<b>Working Height 9.9m</b>	Alternative machines C125D Manufacturer Skyjack	<b>Working Height 9.92m</b>	Alternative machines C125D C125D-O Manufacturer Skyjack
Closed Length 2.31m		Closed Length 2.32m	
Closed Height 2.15m		Closed Height 2.37m	
Stowed Height (guardrail lowered) 1.79m		Stowed Height (guardrail lowered) 1.61m	
Closed Width 1.17m		Closed Width 1.72m	
Platform Size 2.11m x 1.07m		Platform Size 2.44m x 1.42m	
Platform Length (stack extended) 3.05m		Platform Length (stack extended) 3.96m	
Max G.Wt. 456kg		Max G.Wt. 567kg	
Weight 2150kg		Weight 3309kg	

0345 745 0000  
nationwideplatforms.co.uk

Nationwide Platforms  
A LOXAM Company

Previous page      Back to home / contents page      Next page

## How to navigate through this document

Use these navigation buttons to jump straight to the product range where you'll find the products in ascending height order.

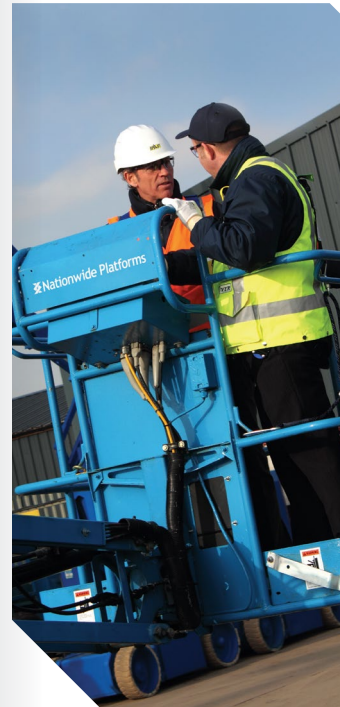

- LOW LEVEL
- SCISSORS
- BOOMS
- VANS
- TRUCK MOUNTED
- TRACKED BOOMS
- TELE-HADLERS
- SAFETY, ATTACHMENTS, ACCESSORIES

**0345 745 0000**  
nationwideplatforms.co.uk



If you can't find exactly what you're looking for or need more information, call our expertly trained staff.

# Contents

## Use this guide to find your perfect powered access solution.

Each section in this guide has been created to allow you to browse, select and order your ideal machine, attachments and accessories.

### Information

Introduction	1
How to use this guide	4
Equipment Selection	5
Location	6
Safety	7
Stay connected	8
iPAF Rental+	8
Regulations	9
Training	10
Indemnity	11
Service & Hire Options	11
Equipment Sales	12

### Product Specification

Low Level Access	13
Scissor Lifts	21
Boom Lifts	51
Van Mounted	82
Truck Mounted	85
Tracked Boom Lifts	102
Telehandlers	110
Safety Solutions, Attachments & Accessories	121

### Useful Data

Weight Conversion	130
Distance Conversion	130



# How to use this guide

## This guide is designed to help you select and order the correct piece of equipment for your needs.

Each section is conveniently separated by product type and machines are arranged in order of ascending height.

The working envelope and height/reach indicator will provide a quick visual reference to assist your equipment selection.

If you cannot find exactly what you're looking for, need more information, or wish to order equipment, call our expertly trained staff on **0345 745 0000**

- 1 Product Code**  
Unique reference number for product. (Please note this will not necessarily correspond with the original manufacturer's model number or product code)
- 2 Specification**  
These details include product dimensions, Safe Working Load (SWL), platform area, rotation and machine weight.
- 3 Key**  
These symbols indicate standard features and optional extras available to hire with the platform. See right for key table.

- 4 Working Envelope**  
This shows the area of working space provided by the product.
- 5 Product Type**  
Indicates classification of powered access unit, e.g. machine types: low level access, scissor lift, boom lift, truck or van mounted platform, specialist boom or telehandler.

- 6 Alternative Machines**  
Indicates alternative or similar machines.
- 7 Working Height**  
The blue column indicates the safe operating vertical height.

- 8 Horizontal Outreach**  
The grey column indicates the safe operating outreach.

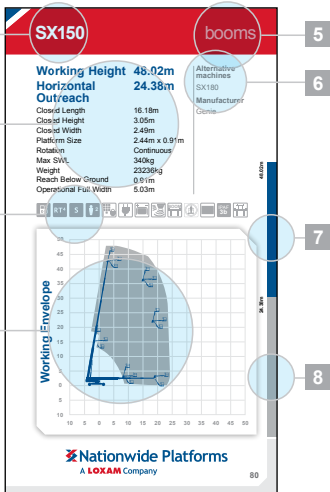

### Height and outreach

Working height Horizontal outreach

## Key

### Standard features

Battery power	<b>IPAF 1a</b> IPAF licence type	Outrigger legs
Diesel power	<b>IPAF 1b</b> IPAF licence type	2 Maximum people in cage*
Lithium battery	<b>IPAF 3a</b> IPAF licence type	Push around vehicles
Hybrid power	<b>IPAF 3b</b> IPAF licence type	Operator powered
Dual fuel option	<b>IPAF PAV</b> IPAF licence type	Indoor use only
Gas power option	<b>T</b> Tracked	Self drive
<b>RT<sup>2</sup></b> Rough terrain (2 wheel drive)	<b>M</b> Mast boom	JIB rotation
<b>RT<sup>4</sup></b> Rough terrain (4 wheel drive)	<b>A</b> Articulating boom	<b>C1</b> IPAF driving licence type
Non-marking tyres	<b>S</b> Straight telescopic boom	

### Optional extras

SkyShield	SkySiren®	SkyScreen™
SkySiren® PCS™	MHA Material Handling Attachments	Power to platform
SkySentry™	Generator	Camera pod
SkyRak®	Circular camera cage	Wendy lighting frame
SkyRakPlus®	SkyTel™	SkyRakMulti™
SkyRakBoom®		
SkyTel™		
SkyRakEdge™		

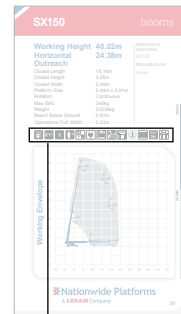



# Equipment Selection

## Considerations in selecting the right equipment for your task.

Before you get started, it's essential you make sure you have the right training to work safely and legally. Call us to learn more about our training services.

# 1

### Height & Outreach

**Do I need to reach a height straight up or do I need to reach up and then over?**

For vertical access, scissor lifts may be best. When working over racking and shelving, mast booms are ideal. When working over obstacles, articulated booms provide a versatile solution.

# 2

### Environment

**Will I be working indoors or outdoors?**

Use a zero emission electric machine indoors, and in general a diesel machine outdoors. For versatility, consider a dual fuel unit.

# 3

### Terrain

**What are the ground conditions I'll be working on?**

If you're working indoors, consider non-marking tyres. On rough terrain select a four wheel drive option and select outriggers on sloping ground.

# 4

### Access

**Are there any access restrictions to entering the working environment?**

Indoors, will machines pass through doorways and lift shafts? Does the site have plant weight restrictions?

# 5

### Working height

**How far up and how far out do I need to reach?**

Always check the working envelope diagrams to ensure the outreach required can be achieved at the height(s) you need to carry out your task. Also consider that maximum working heights are assumed as 2m above the platform height (feet level).

# 6

### Hire duration

**How long do I need a machine for?**

Self drive and other vehicle mounted platforms may suit short projects. We offer machine hires from one day to many years, as well as equipment for outright purchase.

0345 745 0000  
nationwideplatforms.co.uk



 **Nationwide Platforms**  
A **LOXAM** Company

# Location

## Supporting you at every height

With a fleet of more than 15,500 platforms available to hire across the UK, you can be sure that your perfect solution is never too far away.



### SCOTLAND & NORTH EAST

#### ABERDEEN

Cairn Robin Pipeyard  
Portlethen  
Aberdeen  
AB12 4SB

#### DUNDEE

6 Faraday Street  
Dryburgh Industrial Estate,  
Dundee  
DD2 3QQ

#### GLASGOW

##### Customer Service Centre

Tel. 0345 600 1490

Unit B East Point  
13 Melford Road  
Righead Ind Estate  
Bellshill  
Glasgow  
ML4 3LR

#### GLASGOW CITY

45 Methil Street  
Glasgow  
G14 0AG

#### EDINBURGH

Unit 6D  
Uphall Business Park  
Loaning Hill,  
Broxburn  
West Lothian  
EH52 5NT

### MIDLANDS & THE NORTH

#### BARNSELY

Unit 3  
The Recovery Centre  
Wakefield Rd  
Barnsley  
S71 1NU

#### BIRMINGHAM

##### Customer Service Centre

Tel. 0345 600 1492

Willenhall Road  
Darlaston  
Wednesbury  
West Midlands  
WS10 8JG

#### BLACKBURN

New Trees Garage  
Myerscough Road  
Mellor Brook,  
Blackburn  
BB2 7LB

#### DURHAM

##### Customer Service Centre

Tel. 0345 600 1496

Damson Way  
Dragon Ville  
Industrial Estate  
Durham  
DH1 2YN

#### LEEDS

Tel. 0345 600 1491

Old Run Road  
Unit 1, Blackburn  
Works, Hunslet  
Leeds  
LS10 2AA

#### LEICESTER

Unit 10-11  
Arkwright Hill Farm  
Lutterworth Road  
(A426) Nr Cosby,  
LE9 1RH

#### LIVERPOOL

Knowsley Industrial Estate,  
Yardley Road  
Kirkby, Liverpool  
L33 7SS

#### NORTH WALES

Castle Close  
Hawarden Industrial Park,  
Hawarden,  
Deeside  
CH5 3QZ

#### NOTTINGHAM

Unit 21  
Hazelford Way  
Newstead  
NG15 0DQ

#### SCUNTHORPE

7 Atkinson Way  
Foxhill Industrial Estate,  
Scunthorpe,  
DN15 8QJ

#### STOCKTON ON TEES

1 Hurricane Court  
Stockton-on-Tees  
TS18 3TL

0345 745 0000  
nationwideplatforms.co.uk



 **Nationwide Platforms**  
A **LOXAM** Company

## WARRINGTON

**Customer Service Centre**  
**Tel. 0345 600 1491**  
Unit D, Appleton Industrial Park  
Barleycastle Lane  
Appleton Thorn  
Warrington  
WA4 4QT

## WELLINGBOROUGH

Sidegate Lane  
Wellingborough  
Northants  
NN8 1RN

## SOUTH WEST & SOUTH WALES

### AVONMOUTH

Victoria Road  
Avonmouth  
Bristol  
BS11 9DB

### DIDCOT

Hawksworth  
Industrial Estate  
Didcot, Oxfordshire  
OX11 7HR

### BRISTOL

**Customer Service Centre**  
**Tel. 0345 600 1494**  
Cumberland House  
Ashton Gate  
Marsh Road,  
Bristol  
BS3 2NA

## CARDIFF

**Tel. 0345 600 1494**  
Castle Works  
East Moors Road  
Cardiff  
CF24 5NN

## LISKEARD

**Customer Service Centre**  
**Tel. 0345 600 1495**  
Moorswater Industrial Estate, Liskeard  
Cornwall  
PL14 4LB

## SWANSEA

Unit 8 RVB Park  
Carnffrwd Way  
Enterprise Park  
Swansea  
SA6 8QD

## SOUTHAMPTON

Claylands Road  
Industrial Estate  
Bishops Waltham  
SO32 1BH

## TAUNTON

Venture Way  
Priorswood Industrial Estate, Taunton  
Somerset  
TA2 8DE

## SOUTH EAST

### BRENTWOOD

Childerditch  
Childerditch Park  
Childerditch Hall Drive,  
Brentwood  
CM13 3HD

### KENT

Plot 1, Thameside  
Terminal, Cliffe  
Nr Rochester  
Kent  
ME3 7SU

## LONDON EAST

**Customer Service Centre**  
**Tel. 0345 600 1493**

6 Oliver Road  
West Thurrock  
Essex  
RM20 3ED

## LONDON WEST

West London  
Industrial Park  
Iver Lane, Cowley,  
Uxbridge  
UB8 2JG

## LUTON

**Customer Service Centre**  
**Tel. 01582 578074**  
Unit 12 Decora Way  
Sundon Park Ind Estate,  
Luton,  
LU3 3HP

## NORWICH

Rookery Farm  
Silver Street,  
Besthorpe  
Norwich  
NR17 2LD

# Your safety, our priority.

At Nationwide Platforms, safety is always our number one priority.

That's why every single step we take to serve you has been designed with your welfare and wellbeing in mind.

We'd like to invite you to join our safety journey and see why you can always trust our products and services to provide the safeguard you need.



**YOUR SAFETY  
OUR PRIORITY**

**0345 745 0000**  
**nationwideplatforms.co.uk**



**Nationwide Platforms**

A **LOXAM** Company

For all the latest news, promotions, guidance and more, why not check out our social media channels?

 Join us on  
[LinkedIn.com/NationwidePlatforms](https://www.linkedin.com/company/nationwideplatforms)

 Like us on  
[Facebook.com/NationwidePlatforms](https://www.facebook.com/NationwidePlatforms)

 Follow us on Twitter  
[@NWPlatforms](https://twitter.com/NWPlatforms)

 Watch our latest videos on  
[YouTube.com/NationwidePlatforms](https://www.youtube.com/NationwidePlatforms)



0345 745 0000  
[nationwideplatforms.co.uk](https://www.nationwideplatforms.co.uk)



**IPAF Rental+ provides assurance to customers at every stage of the MEWP hire/rental process.**

Known in the industry as the independent quality mark for powered access hire companies, IPAF Rental+ is awarded to those who meet the most stringent standards of training, advice, equipment and customer satisfaction set by a committee of the most experienced players in the powered access rental business.

The Gold standard means Nationwide Platforms has displayed exemplary standards recognised by IPAF as a company who provides significant investment to go above and beyond the minimum standard.



**Nationwide Platforms has been awarded with Gold IPAF Rental+**



**THE HIGHEST  
STANDARD IN  
POWERED ACCESS  
EQUIPMENT HIRE**

# Regulations

## Knowing your requirements

If you're working at height, it's important to understand the legislation and regulations which apply to you.

The Work at Height Regulations (2005) apply to all work at height where there is a risk of a fall liable to cause personal injury. These regulations are a key starting point for anyone responsible for individuals completing, supervising or planning work at height.

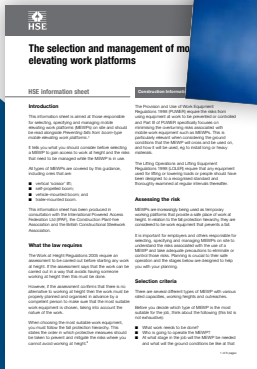

To help you work efficiently and safely at height Nationwide Platforms has a range of in depth guidance notes to aid understanding and implementation of best practice in the work place.

These useful and informative guides are available on request.



0345 745 0000  
nationwideplatforms.co.uk



**Nationwide Platforms**  
A Loxam Company



## Training Courses

With more IPAF instructors, training centres and experience in delivering courses than anyone else, you can rely on us to get you trained and ready to work safely on your next project.

Our IPAF Operator courses are available to complete at training centres across the UK and can even be held on your own site.

### IPAF Operator Courses

1a Static Vertical Personnel Platform



1b Static Boom



3a Mobile Vertical



3b Mobile Boom



Push Around Vertical (PAV)



Advanced Operator Training



Our complete range of training courses are ideal for anyone looking for advanced or specialist training.

Our additional range of training for powered access users includes:

### IPAF MEWPs for Managers

The essential one day course for individuals managing, supervising or planning work at height



We also offer a complete range of courses accredited and approved by:





## PowerGuard

All our machines and equipment is hired out under the Construction Plant Hire Association Model Conditions for hiring of plant (July 2011). These terms and conditions place the responsibility on the hirer for any loss or damage of the equipment hired.

With the cost of loss and damage potentially running into thousands of pounds, PowerGuard offers a peace of mind indemnity to our hire customers.

Two levels of PowerGuard are available:

**Gold** (damage only) and **Platinum** (damage and loss).\*

## Protect yourself against costs of machine damage or loss



handrail  
**£2,500**

controller  
**£600**

cage  
**£3,000**

engine  
**£7,000**

battery  
**£1,800**

machine  
**£200,000**

tyres  
**£1,000**

For more information on the advantages of our PowerGuard scheme or to add PowerGuard to your account, contact us on **0345 745 0000**.

\*Subject to terms & conditions.

## Whatever you're looking to achieve, we're proud to offer you a range of flexible hire & maintenance options.

### Long term hire

In addition to our daily, weekly and monthly hire options, we can also offer long term agreements ideal for ongoing maintenance tasks and large projects.

#### Suitable for:

- Warehouse and logistics applications
- Long term maintenance and refurbishment projects
- Day to day facilities management tasks in retail, office, commercial and arena settings

### Technical & maintenance services

In addition to providing adaptable maintenance packages for short and long term hires, we can also offer you technical support in managing your own fleet requirements.

**For professional advice & guidance in selecting the most suitable solution for your needs contact us today**





# Equipment Sales

The UK's widest selection of new and used access platforms is available to buy now from Nationwide Platforms.

Whether you're seeking a unit from our leading fleet or looking for a brand new model direct from the manufacturer, we have the resources, expertise and know-how to find your perfect solution. We are also refurbishing units out of the fleet.

What's more, we also offer a range of finance and servicing packages.

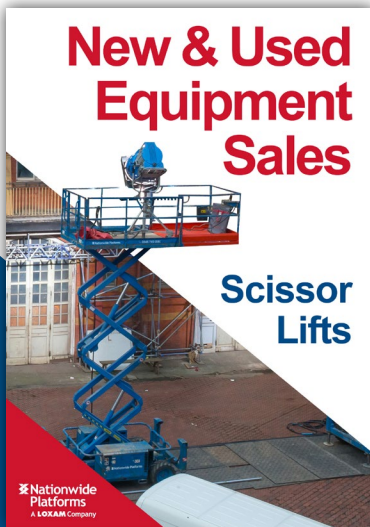

**New & Used  
Equipment  
Sales**

**Scissor  
Lifts**

Nationwide  
Platforms  
A LOXAM Company

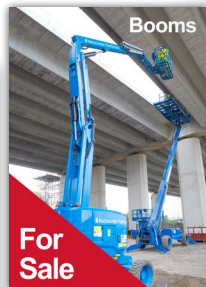

**Booms**

**For  
Sale**



**Trucks**

**For  
Sale**



For information please call  
**0808 100 3604**  
or visit our website...  
[nationwideplatforms.co.uk](http://nationwideplatforms.co.uk)



**Nationwide Platforms**  
A **LOXAM** Company

# Low Level Access



- More than 1,000 units available to hire across the UK
- Working heights up to 9.5m
- Lightweight models from 180kg
- Non-marking tyres for use on finished floors

## Machine type by product code

Pecolift	SJ12
NANO	GR15
NANO SP	SJ16
NANO SP+	GR20
LEONARDO HD	GP20
POWER TOWER	GP25
GR12	



**0345 745 0000**  
**nationwideplatforms.co.uk**



**Nationwide Platforms**  
A **LOXAM** Company



## Working Height 3.5m

Closed Length	0.98m
Closed Height	1.55m
Closed Width	0.75m
Platform Size	0.72m x 0.60m
Max SWL	150kg
Weight	180kg

Alternative machines  
NANO  
Manufacturer  
POWER TOWERS

Indoor use only

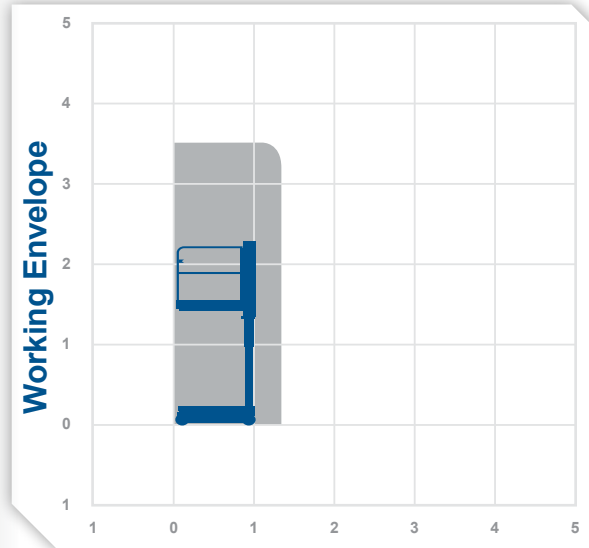

0345 745 0000  
nationwideplatforms.co.uk



We're also pleased to offer wind rated Pecolift models designed for use outdoors. Contact us today to learn more.

### Working Height 4.5m

Closed Length	1.195m
Closed Height	1.56m
Closed Width	0.75m
Platform Size	1.0m x 0.73m
Max SWL	200kg
Weight	285kg

Alternative machines

Nano SP

Manufacturer

POWER TOWERS

Indoor use only

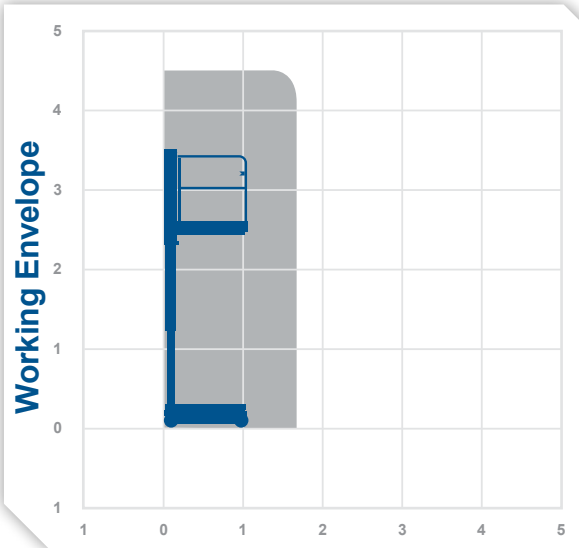

### Working Height 4.5m

Closed Length	1.2m
Closed Height	1.59m
Closed Width	0.75m
Platform Size	1.0m x 0.73m
Platform Length – deck extended	1.5m
Max SWL	200kg
Weight	506kg

Alternative machines

NANO  
NANO SP+

Manufacturer

POWER TOWERS

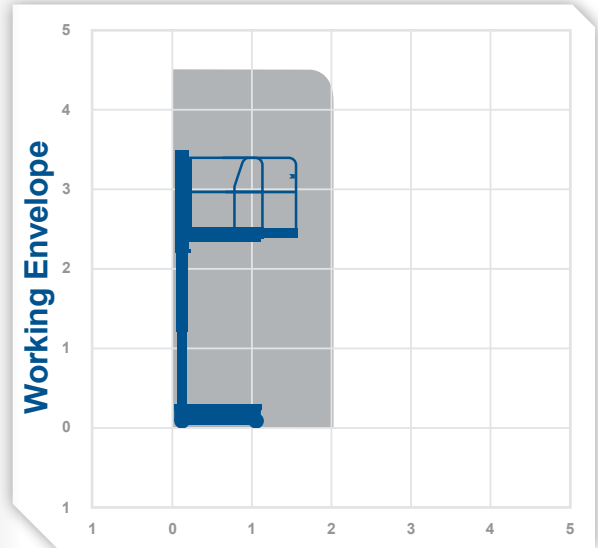

# NANO SP+

low level

## Working Height 4.5m

Closed Length	1.2m
Closed Height	1.59m
Closed Width	0.75m
Platform Size	1.0m x 0.73m
Platform Length – deck extended	2.0m
Max SWL	200kg
Weight	540kg

### Alternative machines

NANO  
NANO SP

### Manufacturer

POWER TOWERS

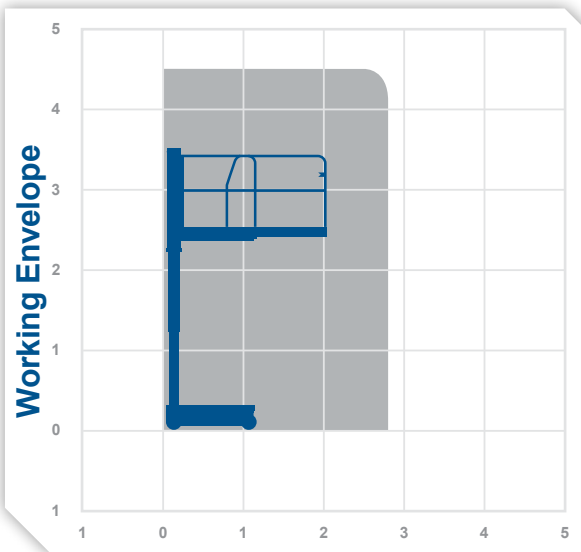

# LEONARDO HD

low level

## Working Height 4.9m

Closed Length	1.04m
Closed Height	1.75m
Closed Width	0.76m
Platform Size	1.04m x 0.63m
Platform Length – deck extended	1.7m
Max SWL	180kg
Weight	555kg
Weight (with Solo-Gyps)	600kg

Manufacturer  
Bravi Platforms

Compatible with  
Solo Gyps  
attachment

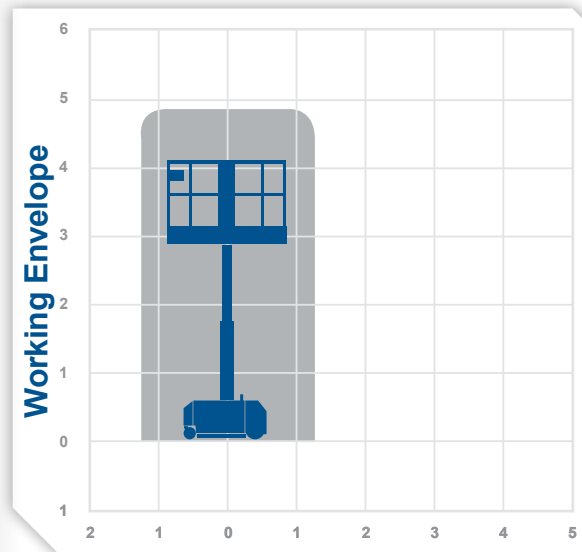

0345 745 0000  
nationwideplatforms.co.uk



 **Nationwide Platforms**  
A **LOXAM** Company

### Working Height 5.1m

Closed Length	1.6m
Closed Height	1.92m
Closed Width	0.78m
Platform Size	1.52m x 0.65m
Max SWL	250kg
Weight	342kg

#### Alternative machines

NANO  
NANO SP

#### Manufacturer

POWER TOWERS

Indoor use only

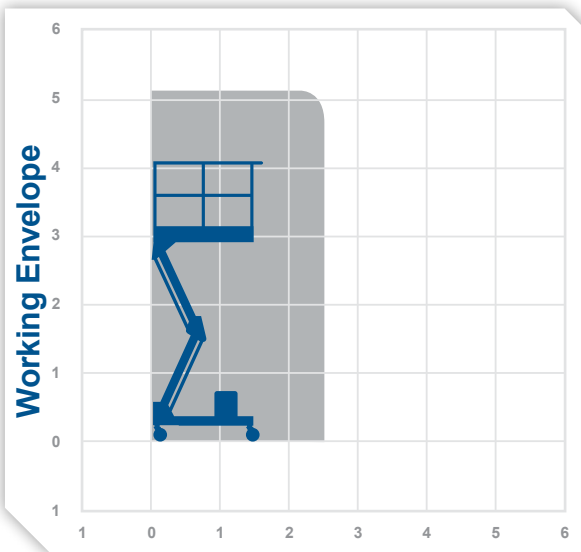

0345 745 0000  
nationwideplatforms.co.uk



### Working Height 5.58m

Closed Length	1.35m
Closed Height	1.79m
Closed Width	0.76m
Platform Size	0.89m x 0.75m
Platform Length - deck extended	1.35m
Max SWL	227kg
Weight	862kg

#### Alternative machines

NANO SP  
GR15

#### Manufacturer

Genie

Indoor use only

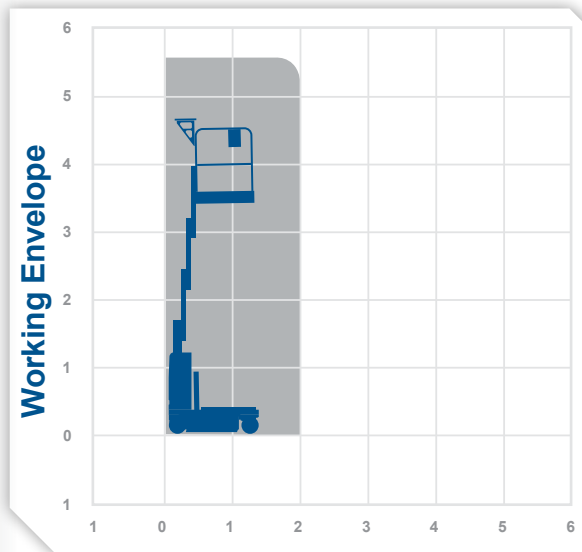

Nationwide Platforms  
A Loxam Company

# SJ12

low level

## Working Height 5.65m

Closed Length	1.78m
Closed Height	1.79m
Closed Width	0.77m
Platform Size	0.93m x 0.69m
Max SWL	227kg
Weight	863kg

### Alternative machines

GR12  
GR15

### Manufacturer

Skyjack

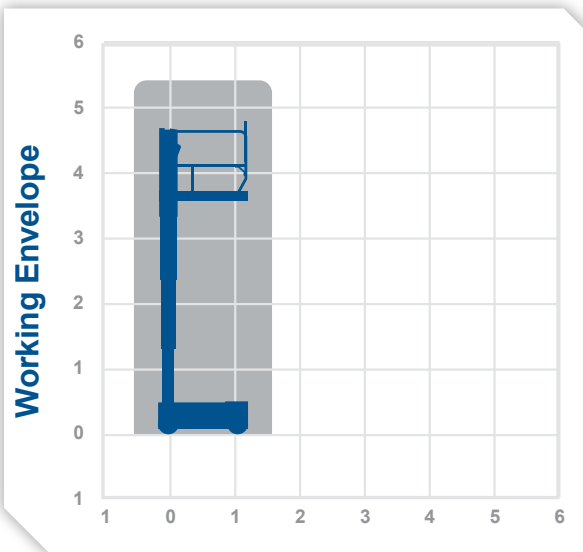

0345 745 0000  
nationwideplatforms.co.uk

# GR15

low level

## Working Height 6.62m

Closed Length	1.45m
Closed Height	1.79m
Closed Width	0.76m
Platform Size	0.94m x 0.75m
Platform Length – deck extended	1.4m
Max SWL	227kg
Weight	994kg

### Alternative machines

GR20  
GR12  
NANO SP

### Manufacturer

Genie

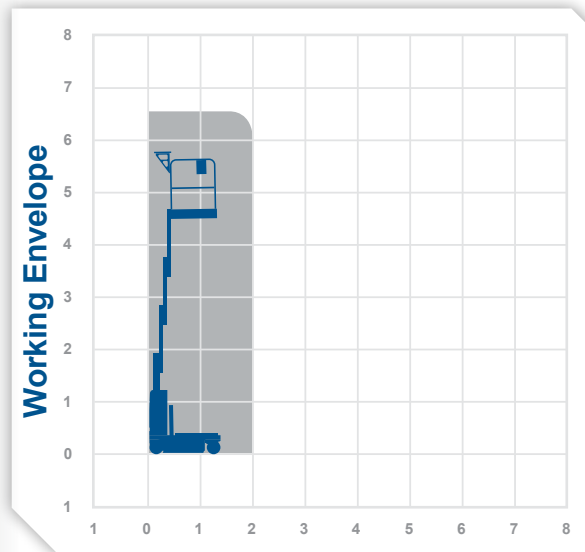

Nationwide Platforms  
A Loxam Company





# SJ16

low level

## Working Height 6.75m

Closed Length	1.37m
Closed Height	1.79m
Closed Width	0.77m
Platform Size	0.69m x 0.85m
Max SWL	227kg
Weight	980kg

### Alternative machines

GR15  
GR20  
1230ES

### Manufacturer

Skyjack

Indoor use only

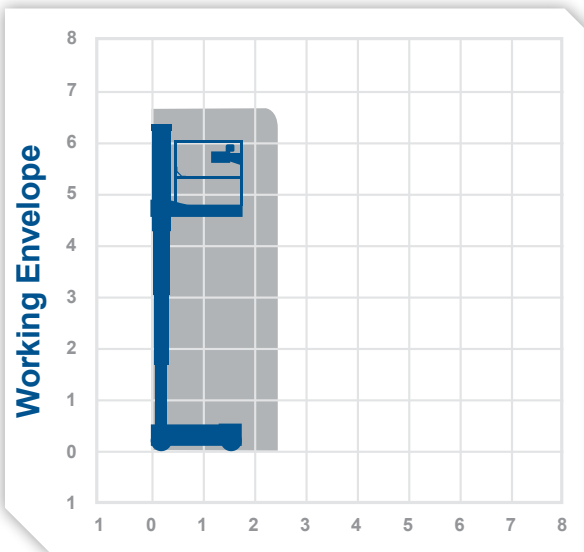

0345 745 0000  
nationwideplatforms.co.uk

# GR20

low level

## Working Height 7.85m

Closed Length	1.35m
Closed Height	1.98m
Closed Width	0.8m
Platform Size	0.89m x 0.75m
Platform Length – deck extended	1.4m
Max SWL	159kg
Weight	1264kg

### Alternative machines

GR15  
GS20  
3219

### Manufacturer

Genie

Indoor use only

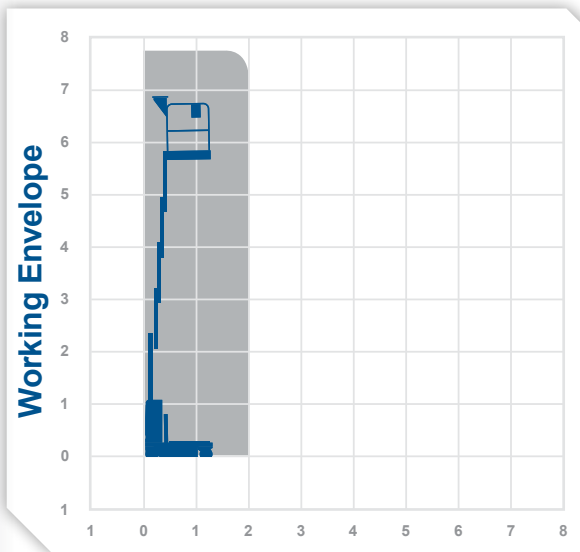

Nationwide Platforms  
A Loxam Company



# GP20

## low level

### Working Height 8.12m

Closed Length	1.27m
Closed Height	1.98m
Closed Width	0.74m
Platform Size	1.14m x 0.66m
Max SWL	159kg
Weight	347kg

Alternative machines

GP25

Manufacturer

Genie

Indoor use only

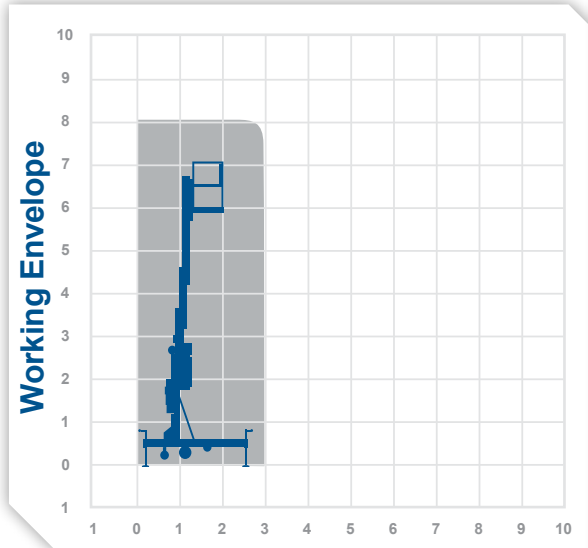

# GP25

### Working Height 9.54m

Closed Length	1.31m
Closed Height	1.98m
Closed Width	0.74m
Platform Size	1.14m x 0.66m
Max SWL	159kg
Weight	330kg

Alternative machines

GP20

Manufacturer

Genie

Indoor use only

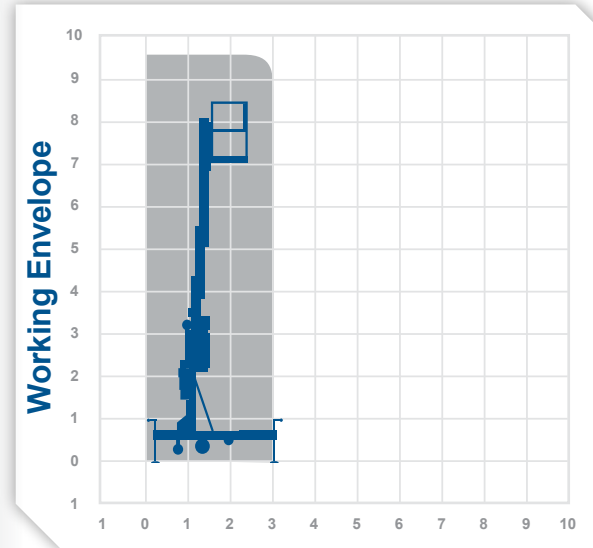

8.12m

9.54m



You can find the latest promotions, competitions and news from Nationwide Platforms by following us on our social media pages.



**Nationwide Platforms**  
A **LOXAM** Company

# Scissors



- More than 7,200 units available to hire across the UK
- Working heights from 7m to 34m
- Lightweight and compact machines
- Direct drive electric machines for greater efficiency
- Double deck and rough terrain
- Variety of power options
- Narrow aisle machines for access to confined areas
- Non-marking tyre option for work on finished floors
- Models with 1,134kg SWL
- Lightweight models from 1,269kg
- Power to platform available

## Machine type by product code

GS1532	GS2632	COM12DX	GS53
SJ3215	COM10N	GS4047	GS53G
OPT8	CO10	COM14	165-12
3219	COM10DX	M4069	195-12
GS1932	6832D	S142-12	HL220H
GS20	4632	9241	HL220D
3220	GS32	8841	S225-24
COM8	GS3232	GS43	SL210
GS26	GS32D-O	GS43G	HL235D
GS2669RT	GS3369RT	S152-12	M250
4626	COM12	9250X	HL275H
6826D	GS33	LL15N	S280-25
GS26D-O	GS3390RT	S175-12	LL26X
3226	GS3390G	H18SX	HL340D

**0345 745 0000**  
**nationwideplatforms.co.uk**



**Nationwide Platforms**  
 A **LOXAM** Company

# GS1532

## scissors

### Working Height 6.4m

Closed Length	1.83m
Closed Height	2.03m
Stowed Height (guardrails lowered)	1.73m
Closed Width	0.81m
Platform Size	1.63m x 0.74m
Platform Length (deck extended)	2.54m
Max SWL	272kg
Weight	1269kg

#### Alternative machines

3215  
3219  
GS1932

#### Manufacturer

Genie

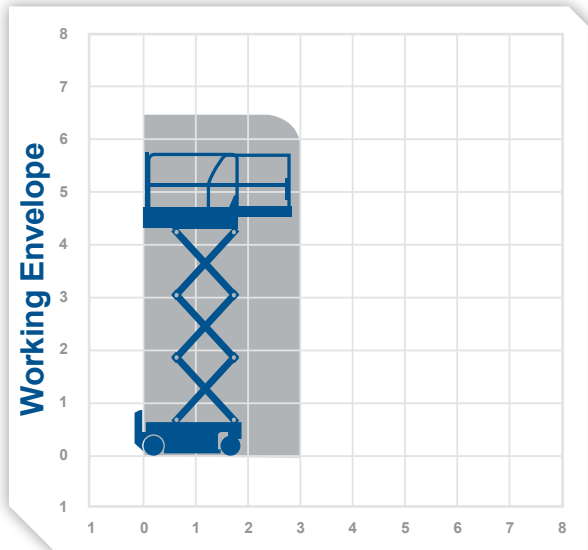

# SJ3215

## scissors

### Working Height 6.57m

Closed Length	1.55m
Closed Height	2.03m
Stowed Height (guardrails lowered)	1.67m
Closed Width	0.81m
Platform Size	1.55m x 0.66m
Platform Length (deck extended)	2.46m
Max SWL	272kg
Weight	1148kg

#### Alternative machines

GS1532

#### Manufacturer

SkyJack

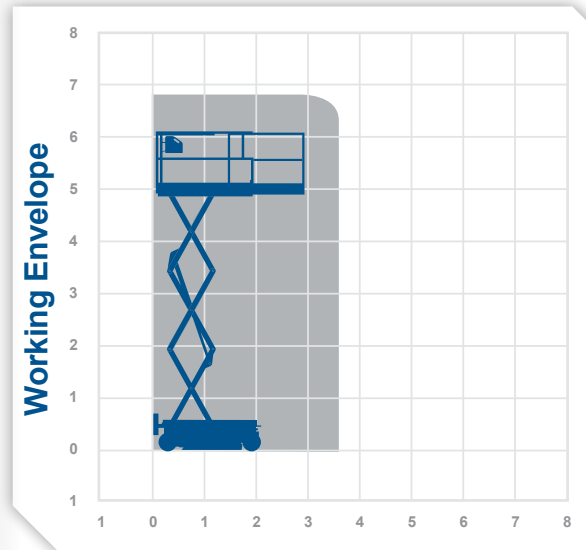

0345 745 0000  
nationwideplatforms.co.uk



**Nationwide Platforms**  
A **LOXAM** Company

**Working Height 7.77m**

Closed Length	1.9m
Closed Height	1.98m
Stowed Height (guardrails lowered)	1.98m
Closed Width	0.79m
Platform Size	0.74m x 1.72m
Platform Length (deck extended)	2.59m
Max SWL	230kg
Weight	1520g

**Alternative machines**

3220  
GS1932  
GS20

**Manufacturer**

Haulotte

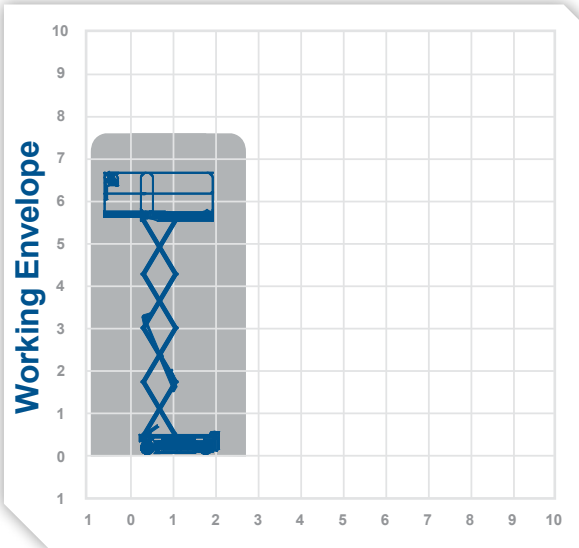
**Working Height 7.8m**

Closed Length	1.78m
Closed Height	2.11m
Stowed Height (guardrails lowered)	1.64m
Closed Width	0.81m
Platform Size	1.63m x 0.71m
Platform Length (deck extended)	2.53m
Max SWL	227kg
Weight	1312kg

**Alternative machines**

GS1932  
GS20

**Manufacturer**

SkyJack

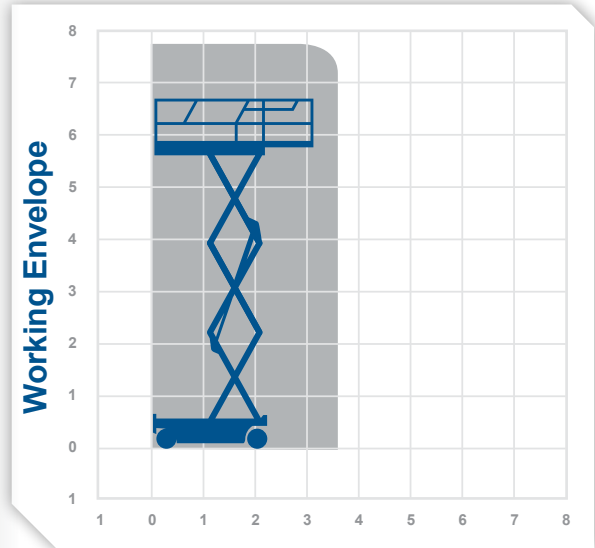

**0345 745 0000**  
**nationwideplatforms.co.uk**



**Nationwide Platforms**  
A **LOXAM** Company

# GS1932

## scissors

### Working Height 7.8m

Closed Length	1.82m
Closed Height	2.11m
Stowed Height (guardrails lowered)	1.76m
Closed Width	0.81m
Platform Size	1.64m x 0.74m
Platform Length (deck extended)	2.54m
Max SWL	227kg
Weight	1503kg

#### Alternative machines

3219  
GS20  
3220

#### Manufacturer

Genie

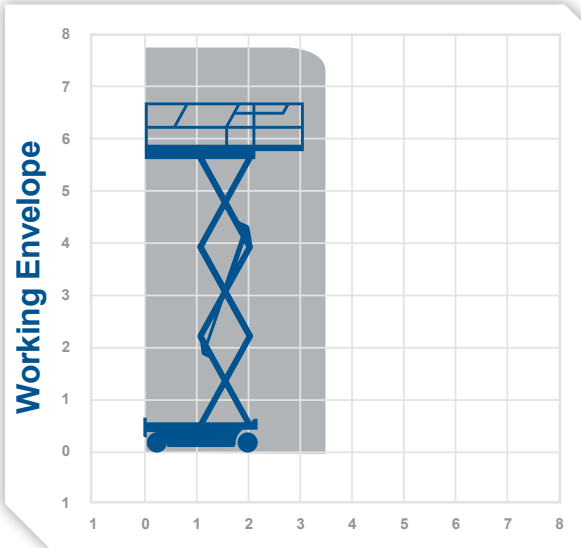

0345 745 0000  
nationwideplatforms.co.uk

# GS20

## scissors

### Working Height 7.92m

Closed Length	2.45m
Closed Height	2.1m
Stowed Height (guardrails lowered)	1.75m
Closed Width	0.81m
Platform Size	2.21m x 0.7m
Platform Length (deck extended)	3.2m
Max SWL	363kg
Weight	1559kg

#### Alternative machines

3220  
COM8

#### Manufacturer

Genie

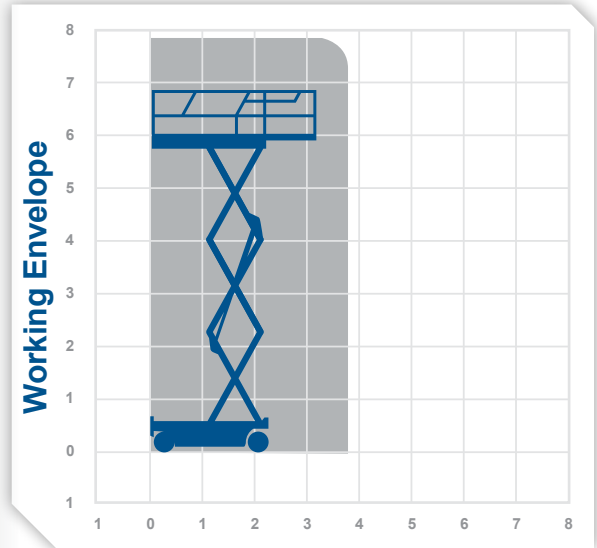

Nationwide Platforms  
A Loxam Company



**Working Height 8.1m**

Closed Length	2.32m
Closed Height	2.08m
Stowed Height (guardrails lowered)	1.73m
Closed Width	0.81m
Platform Size	2.13m x 0.71m
Platform Length (deck extended)	3.04m
Max SWL	408kg
Weight	1594kg

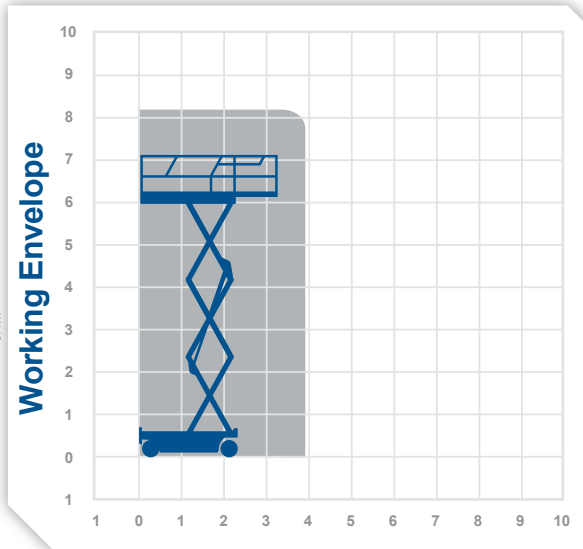
**Alternative machines**GS20  
2030ES**Manufacturer**  
SkyJack**Working Height 8.2m**

Closed Length	2.49m
Closed Height	2.0m
Stowed Height (guardrails lowered)	1.13m
Closed Width	0.81m
Platform Size	0.81m x 2.31m
Platform Length (deck extended)	3.23m
Max SWL	350kg
Weight	1655kg

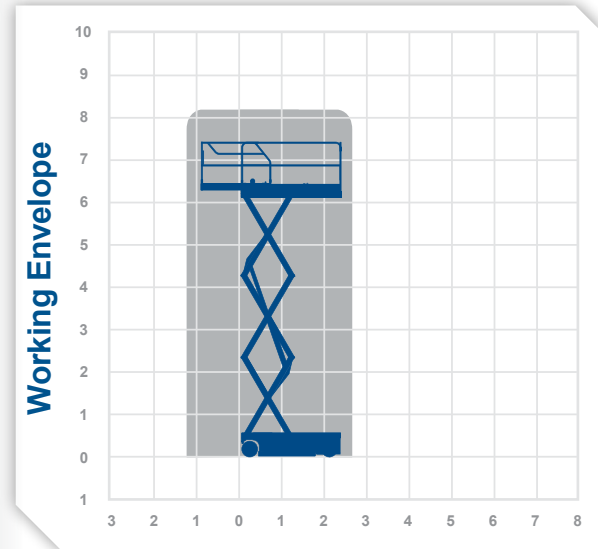
**Alternative machines**GS26  
GS2632  
3226**Manufacturer**  
Haulotte

0345 745 0000  
nationwideplatforms.co.uk



**Nationwide Platforms**  
A **LOXAM** Company



# GS26

# scissors

## Working Height 9.75m

Closed Length	2.45m
Closed Height	2.17m
Stowed Height (guardrails lowered)	1.99m
Closed Width	1.17m
Platform Size	2.21m x 0.94m
Platform Length (deck extended)	3.2m
Max SWL	454kg
Weight	2107kg

### Alternative machines

4626

### Manufacturer

Genie

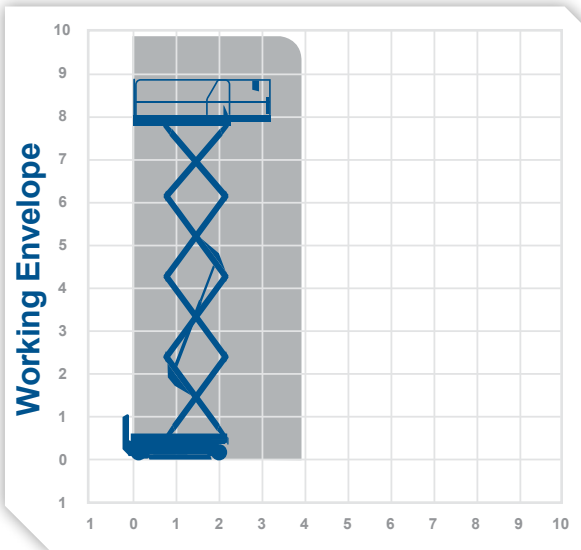

# GS2669RT

# scissors

## Working Height 9.9m

Closed Length	3.12m
Closed Height	2.59m
Stowed Height (guardrails lowered)	1.92m
Closed Width	1.75m
Platform Size	2.79m x 1.6m
Platform Length (deck extended)	4.5m
Max SWL	680kg
Weight	3768kg

### Alternative machines

GS26D-O  
6826D

### Manufacturer

Genie

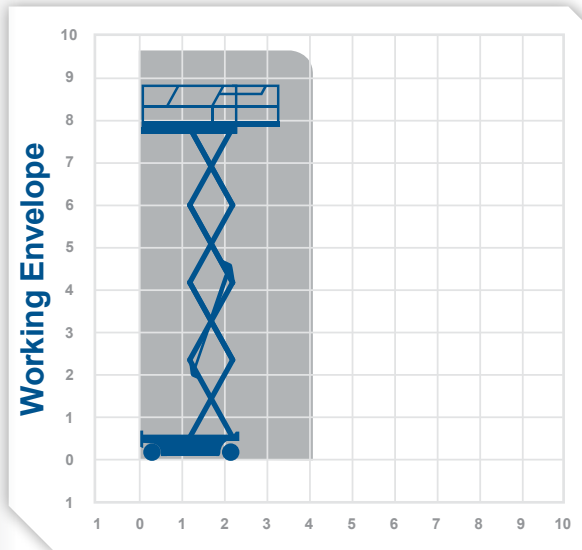

0345 745 0000  
nationwideplatforms.co.uk



**Nationwide Platforms**  
A **LOXAM** Company

# 4626

# scissors

## Working Height 9.9m

Closed Length	2.31m
Closed Height	2.15m
Stowed Height (guardrails lowered)	1.79m
Closed Width	1.17m
Platform Size	2.11m x 1.07m
Platform Length (deck extended)	3.01m
Max SWL	454kg
Weight	2130kg

### Alternative machines

GS26

### Manufacturer

SkyJack

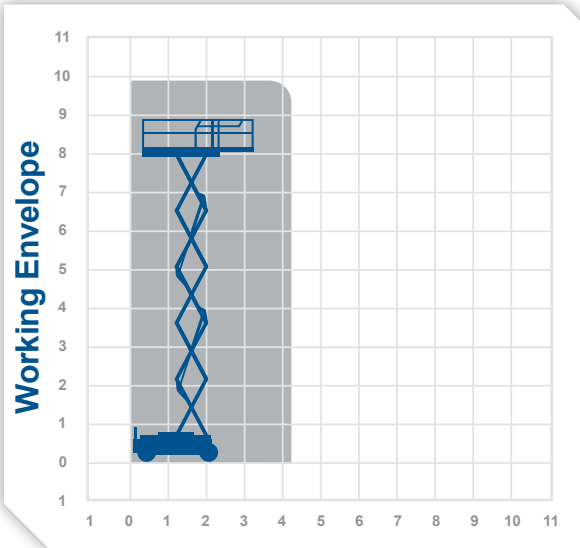

# 6826D

# scissors

## Working Height 9.92m

Closed Length	3.12m
Closed Height	2.37m
Stowed Height (guardrails lowered)	1.61m
Closed Width	1.72m
Platform Size	2.44m x 1.42m
Platform Length (deck extended)	3.94m
Max SWL	567kg
Weight	3305kg

### Alternative machines

GS26D  
GS26D-O

### Manufacturer

SkyJack

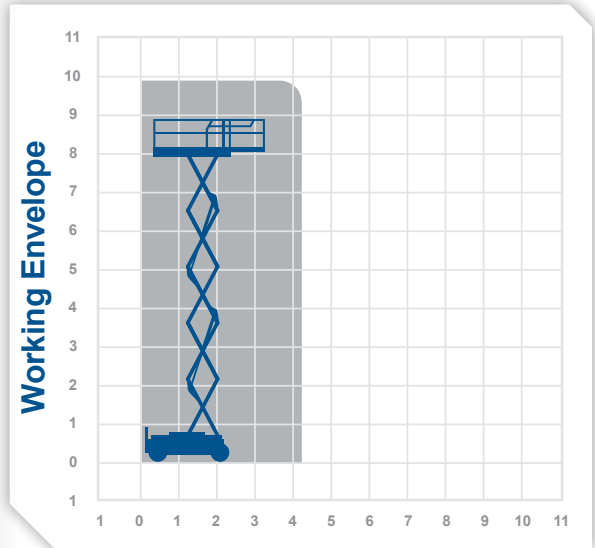

**0345 745 0000**  
[nationwideplatforms.co.uk](http://nationwideplatforms.co.uk)



**Nationwide Platforms**  
 A **LOXAM** Company

## Working Height 9.92m

Closed Length	2.67m
Closed Height	2.35m
Stowed Height (guardrails lowered)	1.7m
Closed Width	1.73m
Platform Size	2.51m x 1.55m
Platform Length (deck extended)	3.96m
Max SWL	567kg
Weight	3455kg

### Alternative machines

GS26D  
6826D

### Manufacturer

Genie

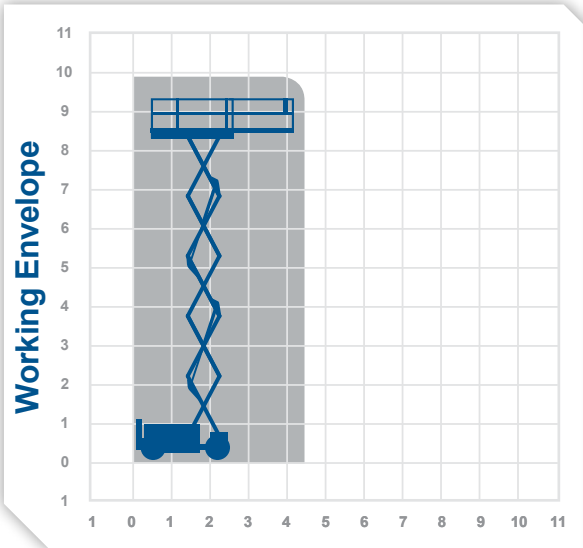

**0345 745 0000**  
nationwideplatforms.co.uk

## Working Height 9.92m

Closed Length	2.32m
Closed Height	2.15m
Stowed Height (guardrails lowered)	1.91m
Closed Width	0.81m
Platform Size	2.13m x 0.71m
Platform Length (deck extended)	3.23m
Max SWL	227kg
Weight	1890kg

### Alternative machines

GS2632

### Manufacturer

SkyJack

Indoor use only

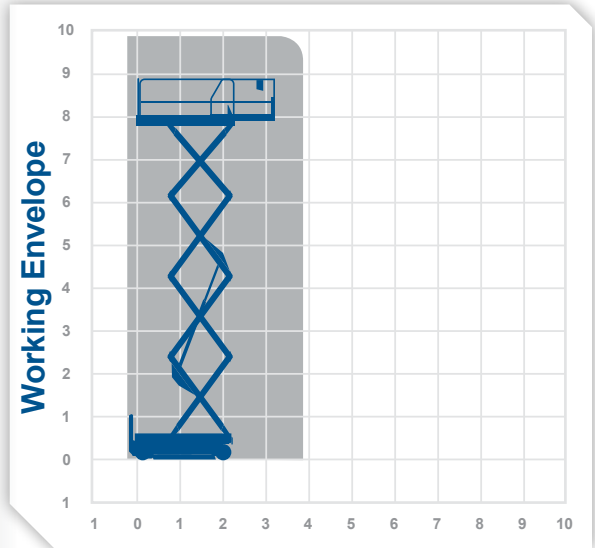

**Nationwide Platforms**  
A **LOXAM** Company



## Working Height 9.92m

Closed Length	2.44m
Closed Height	2.26m
Stowed Height (guardrails lowered)	1.91m
Closed Width	0.81m
Platform Size	2.26m x 0.79m
Platform Length (deck extended)	3.18m
Max SWL	227kg
Weight	1956kg

### Alternative machines

3226  
2630

### Manufacturer

Genie

Indoor use only

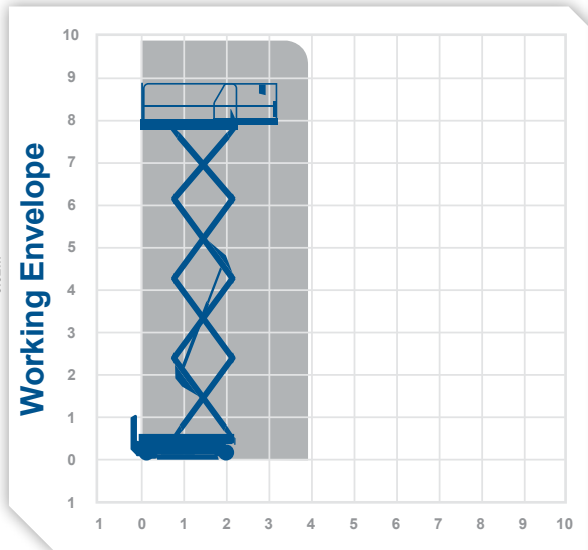

## Working Height 10.0m

Closed Length	2.49m
Closed Height	2.18m
Stowed Height (guardrails lowered)	1.32m
Closed Width	0.81m
Platform Size	0.81m x 2.31m
Platform Length (deck extended)	3.23m
Max SWL	230kg
Weight	2190kg

### Alternative machines

GS2632  
3226

### Manufacturer

Haulotte

Indoor use only

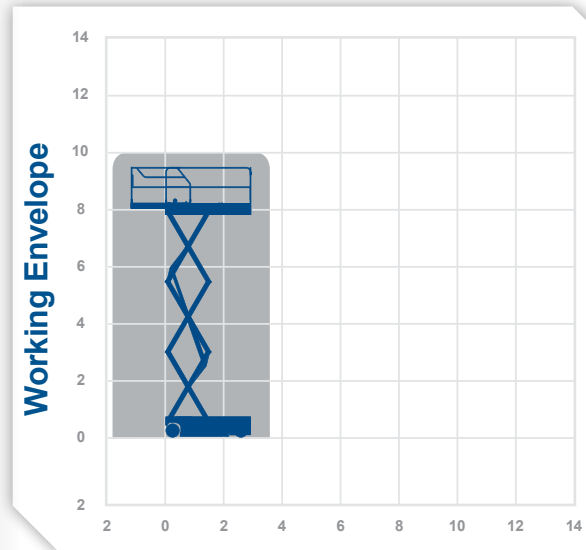

0345 745 0000  
nationwideplatforms.co.uk



**Nationwide Platforms**  
A Loxam Company

# COM10

## scissors

### Working Height 10.15m

Closed Length	2.31m
Closed Height	2.14m
Stowed Height (guardrails lowered)	1.28m
Closed Width	1.2m
Platform Size	2.31m x 1.2m
Platform Length (deck extended)	3.23m
Max SWL	450kg
Weight	2330kg

#### Alternative machines

GS2632  
3226  
COM10N

#### Manufacturer

Haulotte

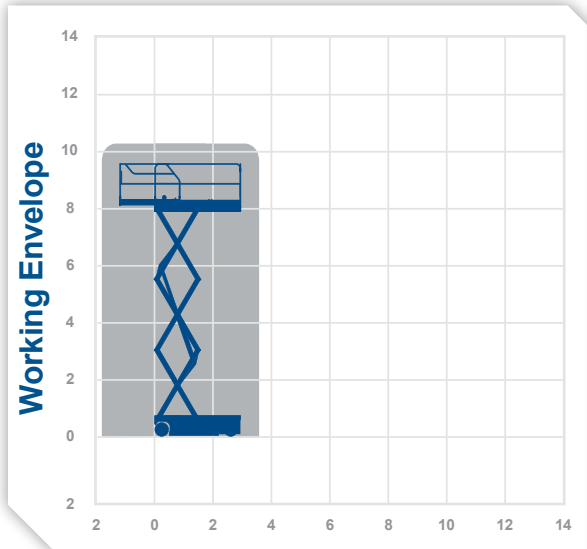

0345 745 0000  
nationwideplatforms.co.uk

# COM10DX

## scissors

### Working Height 10.3m

Closed Length	3.17m
Closed Height	2.44m
Stowed Height (guardrails lowered)	1.59m
Closed Width	1.78m
Platform Size	2.45m x 1.45m
Platform Length (deck extended)	3.7m
Max SWL	565kg
Weight	3520kg

#### Alternative machines

GS26D  
6826D

#### Manufacturer

Haulotte

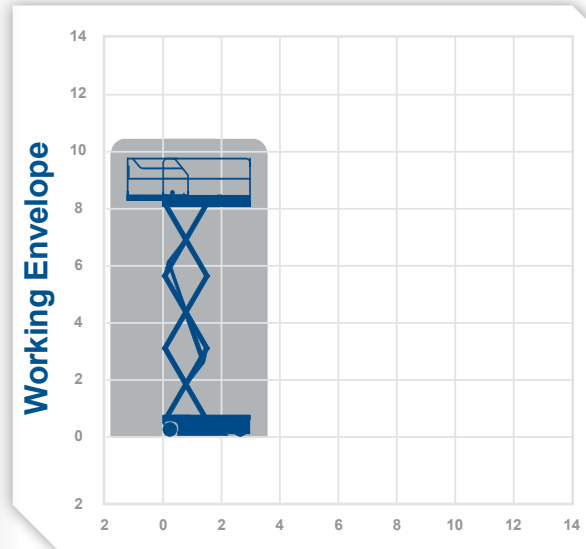

Nationwide Platforms  
A Loxam Company



# 6832D

# scissors

## Working Height 11.75m

Closed Length	3.12m
Closed Height	2.51m
Stowed Height (guardrails lowered)	1.75m
Closed Width	1.72m
Platform Size	2.44m x 1.42m
Platform Length (deck extended)	3.94m
Max SWL	454kg
Weight	3655kg

### Alternative machines

GS32D  
GS32D-O

### Manufacturer

SkyJack

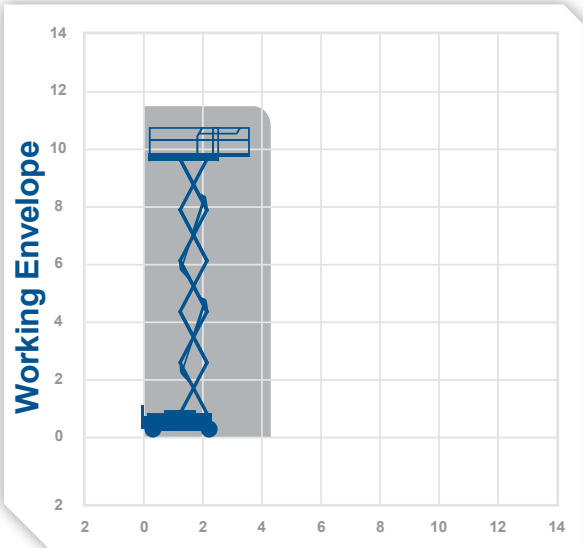

# 4632

# scissors

## Working Height 11.75m

Closed Length	2.31m
Closed Height	2.24m
Stowed Height (guardrails lowered)	1.88m
Closed Width	1.17m
Platform Size	2.11m x 1.07m
Platform Length (deck extended)	3.01m
Max SWL	317kg
Weight	2300kg

### Alternative machines

GS32  
3246

### Manufacturer

SkyJack

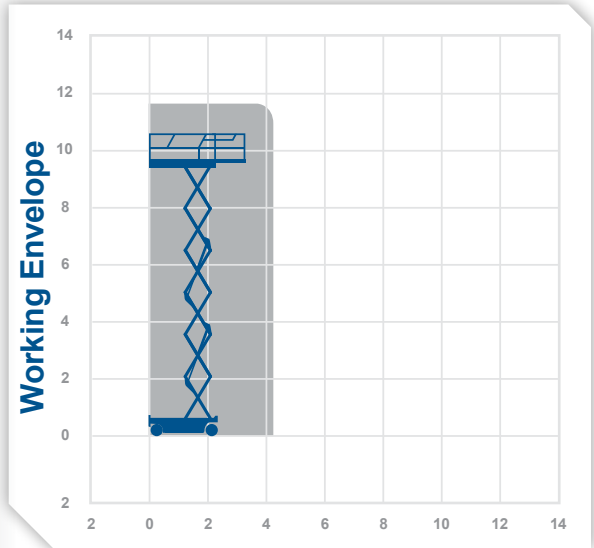

**0345 745 0000**  
[nationwideplatforms.co.uk](http://nationwideplatforms.co.uk)



**Nationwide Platforms**  
 A **LOXAM** Company

## Working Height 11.75m

Closed Length	2.43m
Closed Height	2.3m
Stowed Height (guardrails lowered)	1.8m
Closed Width	1.17m
Platform Size	2.26m x 1.16m
Platform Length (deck extended)	3.25m
Max SWL	318kg
Weight	2796kg

### Alternative machines

4632  
3246

### Manufacturer

Genie

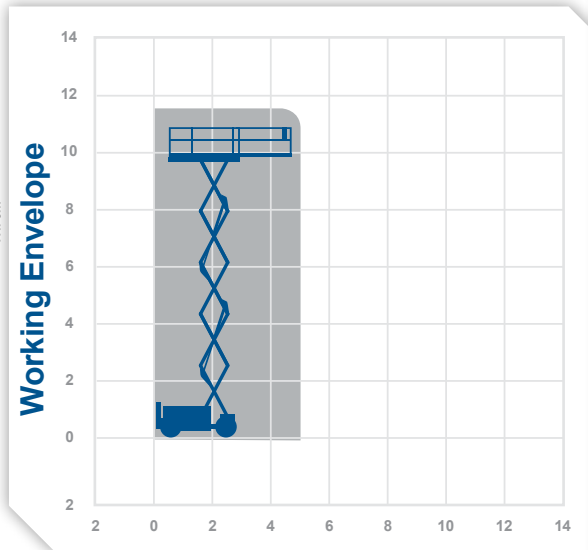

0345 745 0000  
nationwideplatforms.co.uk



## Working Height 11.75m

Closed Length	2.44m
Closed Height	2.44m
Stowed Height (guardrails lowered)	2.03m
Closed Width	0.81m
Platform Size	2.26m x 0.81m
Platform Length (deck extended)	3.33m
Max SWL	227kg
Weight	2352kg

### Alternative machines

GS32

### Manufacturer

Genie

Indoor use only

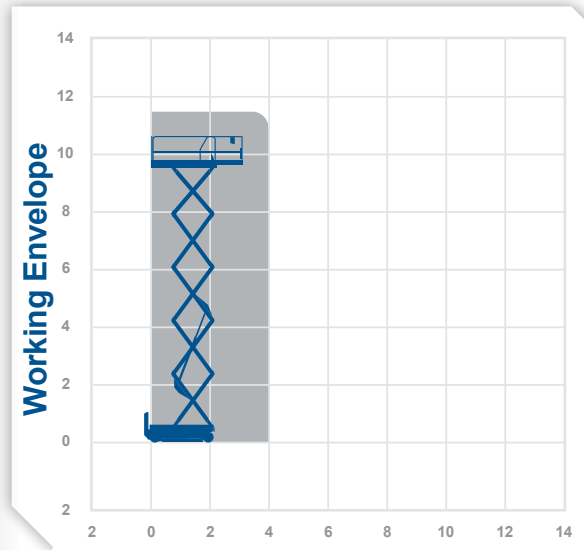

Nationwide Platforms  
A Loxam Company





## Working Height 11.8m

Closed Length	2.67m
Closed Height	2.45m
Stowed Height (guardrails lowered)	1.83m
Closed Width	1.73m
Platform Size	2.51m x 1.55m
Platform Length (deck extended)	3.96m
Max SWL	454kg
Weight	4115kg

Alternative machines  
6832D  
**Manufacturer**  
Genie

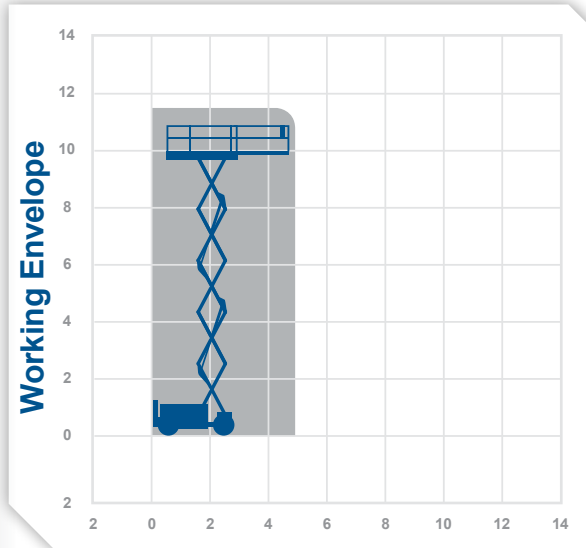

**0345 745 0000**  
nationwideplatforms.co.uk



**Nationwide Platforms**  
A **LOXAM** Company

# GS3369RT

## scissors

### Working Height 11.96m

Closed Length	3.12m
Closed Height	2.59m
Stowed Height (guardrails lowered)	1.92m
Closed Width	1.75m
Platform Size	2.79m x 1.6m
Platform Length (deck extended)	4.5m
Max SWL	454kg
Weight	3949kg

#### Alternative machines

6832D

#### Manufacturer

Genie

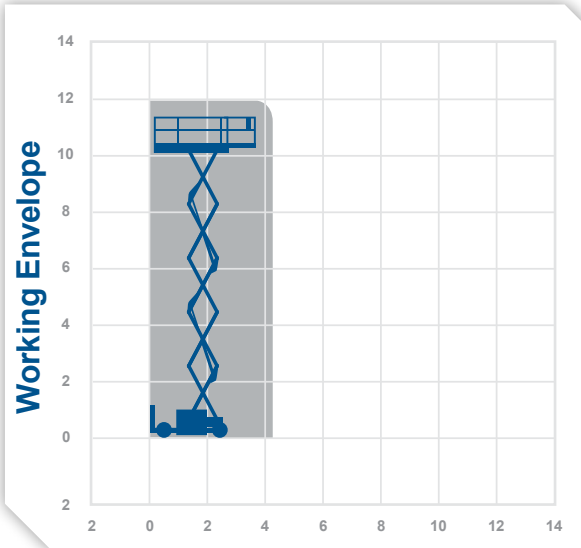

0345 745 0000  
[nationwideplatforms.co.uk](http://nationwideplatforms.co.uk)

# COM12

## scissors

### Working Height 12.0m

Closed Length	2.49m
Closed Height	2.39m
Stowed Height (guardrails lowered)	1.53m
Closed Width	1.2m
Platform Size	1.2m x 2.31m
Platform Length (deck extended)	3.23m
Max SWL	300kg
Weight	2470g

#### Alternative machines

GS32  
4632

#### Manufacturer

Haulotte

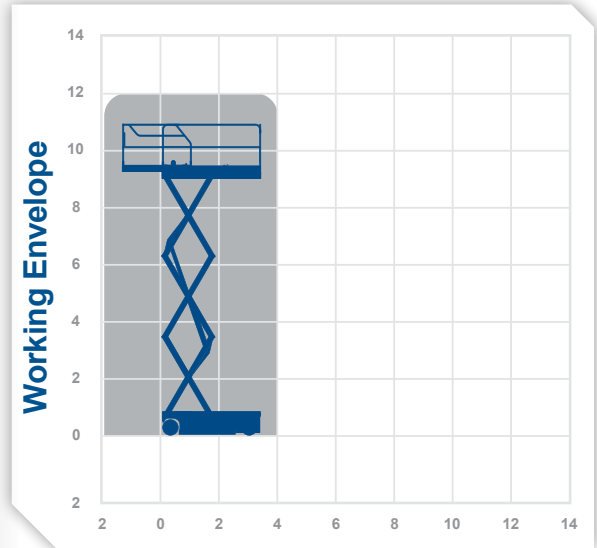

Nationwide Platforms  
 A Loxam Company



# GS33

# scissors

## Working Height 12.06m

Closed Length	4.88m
Closed Height	2.68m
Stowed Height (guardrails lowered)	2.0m
Closed Width	2.13m
Platform Size	3.89m x 1.83m
Platform Length (deck extended)	6.57m
Max SWL	1134kg
Weight	7520kg

### Alternative machines

GS3390RT  
GS43  
6832D  
GS3369RT

### Manufacturer

Genie

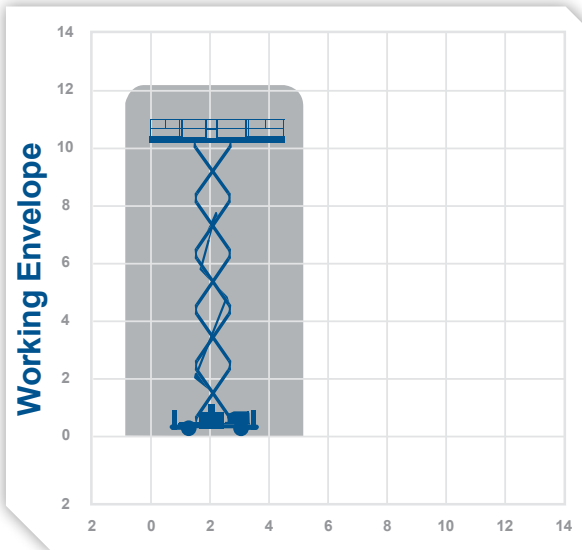

# GS3390RT

# scissors

## Working Height 12.06m

Closed Length	4.88m
Closed Height	2.71m
Stowed Height (guardrails lowered)	2.03m
Closed Width	2.29m
Platform Size	4.81m x 1.83m
Platform Length (deck extended)	7.38m
Max SWL	1134kg
Weight	6890kg

### Alternative machines

GS33  
GS43  
6832D  
GS3369RT

### Manufacturer

Genie

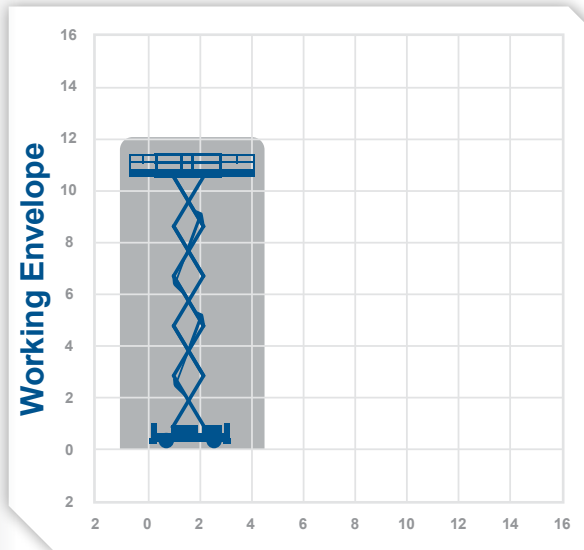

One day of powered access training,  
years of working safely at height.  
Call today and get trained with  
Nationwide Platforms.  
Call: 0345 745 0000



**Nationwide Platforms**  
A **LOXAM** Company

# GS3390G

## scissors

### Working Height 12.06m

Closed Length	4.88m
Closed Height	2.71m
Stowed Height (guardrails lowered)	2.03m
Closed Width	2.29m
Platform Size	4.81m x 1.83m
Platform Length (deck extended)	7.38m
Max SWL	1134kg
Weight	6826kg

#### Alternative machines

GS43G  
GS53G

#### Manufacturer

Genie

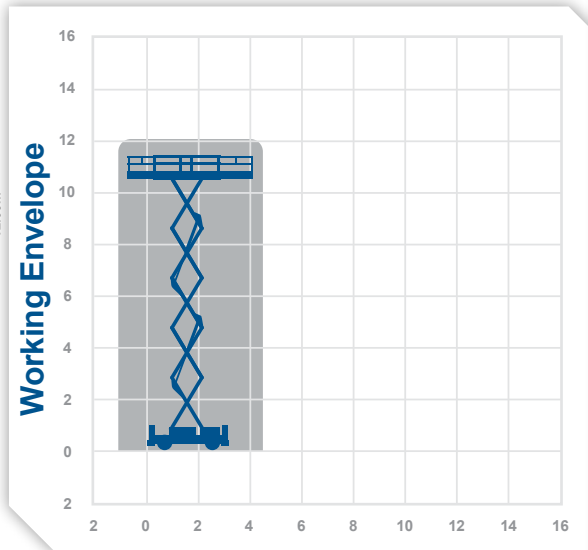

# COM12DX

## scissors

### Working Height 12.06m

Closed Length	3.17m
Closed Height	2.56m
Stowed Height (guardrails lowered)	1.7m
Closed Width	1.78m
Platform Size	1.78m x 2.45m
Platform Length (deck extended)	3.7m
Max SWL	450kg
Weight	4110kg

#### Alternative machines

GS3369RT  
GS32D-O

#### Manufacturer

Haulotte

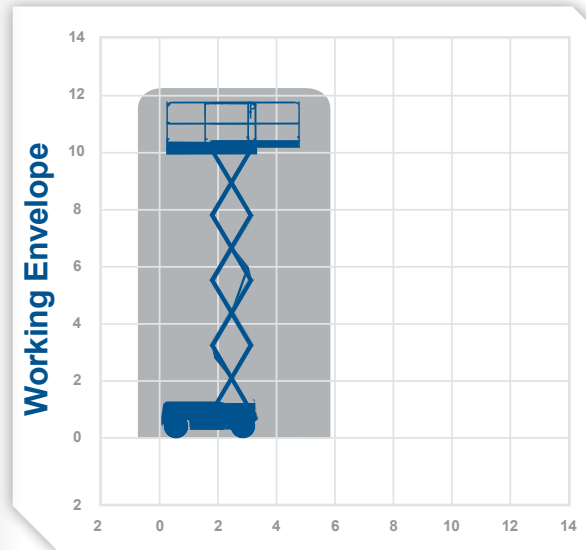

0345 745 0000  
nationwideplatforms.co.uk



**Nationwide Platforms**  
A **LOXAM** Company

# GS4047

## scissors

### Working Height 13.7m

Closed Length	2.44m
Closed Height	2.54m
Stowed Height (guardrails lowered)	1.88m
Closed Width	1.19m
Platform Size	2.26m x 1.15m
Platform Length (deck extended)	3.36m
Max SWL	350kg
Weight	3221kg

#### Alternative machines

COM14  
S142-12  
S152-12

#### Manufacturer

Genie

Indoor use only

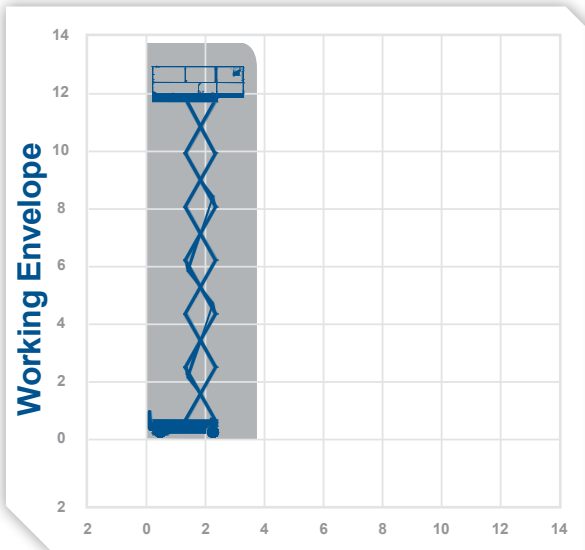

# COM14

## scissors

### Working Height 13.8m

Closed Length	2.74m
Closed Height	2.5m
Stowed Height (guardrails lowered)	2.08m
Closed Width	1.2m
Platform Size	2.3m x 1.2m
Platform Length (deck extended)	3.22m
Max SWL	350kg
Weight	3175kg

#### Alternative machines

LL15N  
S142-12  
S152-12

#### Manufacturer

Haulotte

Indoor use only

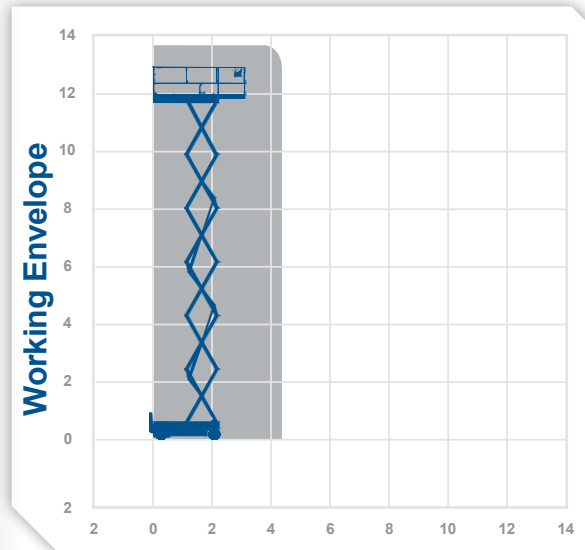

0345 745 0000  
nationwideplatforms.co.uk



**Nationwide Platforms**  
A Loxam Company

# M4069

## scissors

### Working Height 14.19m

Closed Length	3.1m
Closed Height	2.83m
Stowed Height (guardrails lowered)	2.01m
Closed Width	1.75m
Platform Size	2.92m x 1.65m
Platform Length (deck extended)	3.83m
Max SWL	360kg
Weight	5700kg

#### Alternative machines

4069  
4069-O

#### Manufacturer

JLG

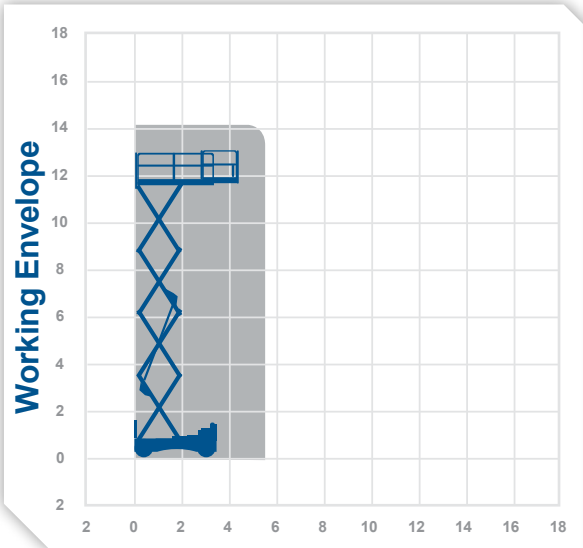

0345 745 0000  
nationwideplatforms.co.uk



# S142-12

## scissors

### Working Height 14.2m

Closed Length	2.71m
Closed Height	2.76m
Stowed Height (guardrails lowered)	1.98m
Closed Width	1.2m
Platform Size	2.5m x 1.2m
Platform Length (deck extended)	3.7m
Max SWL	350kg
Weight	3400kg

#### Alternative machines

S152-12  
COM14  
GS4047

#### Manufacturer

HAB

Indoor use only

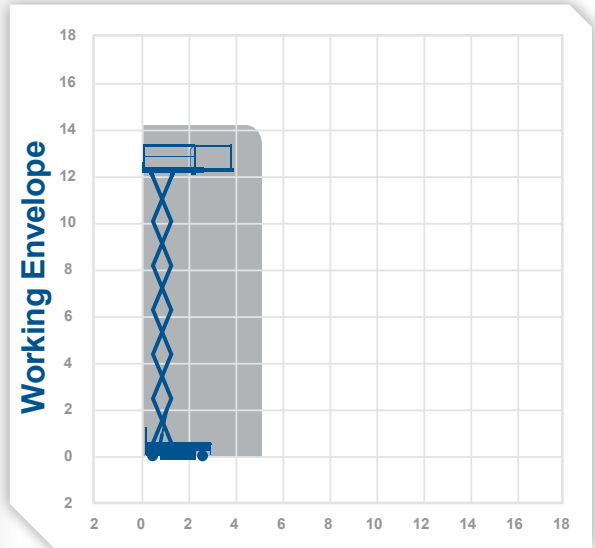

Nationwide Platforms  
A Loxam Company

# 9241

# scissors

## Working Height 14.5m

Closed Length	4.5m
Closed Height	2.8m
Stowed Height (guardrails lowered)	2.0m
Closed Width	2.3m
Platform Size	4.30m x 1.90m
Platform Length (deck extended)	7.2m
Max SWL	681kg
Weight	6715kg

### Alternative machines

8841  
GS43

### Manufacturer

SkyJack

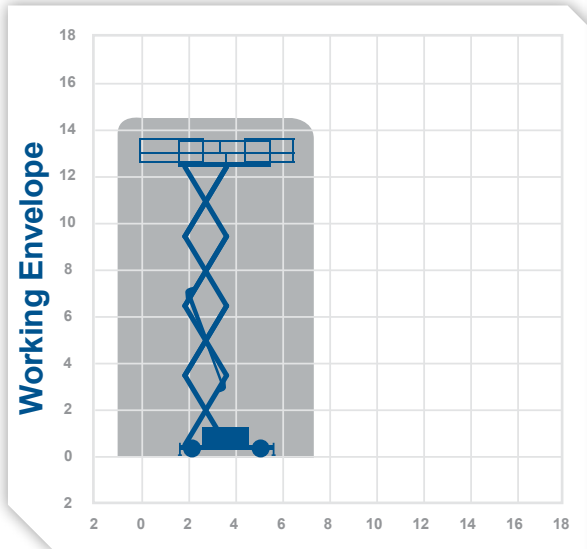

**0345 745 0000**  
[nationwideplatforms.co.uk](http://nationwideplatforms.co.uk)



# 8841

# scissors

## Working Height 14.5m

Closed Length	3.49m
Closed Height	2.9m
Stowed Height (guardrails lowered)	2.22m
Closed Width	2.21m
Platform Size	3.51m x 1.76m
Platform Length (deck extended)	4.71m
Max SWL	680kg
Weight	5289kg

### Alternative machines

9241  
GS43

### Manufacturer

SkyJack

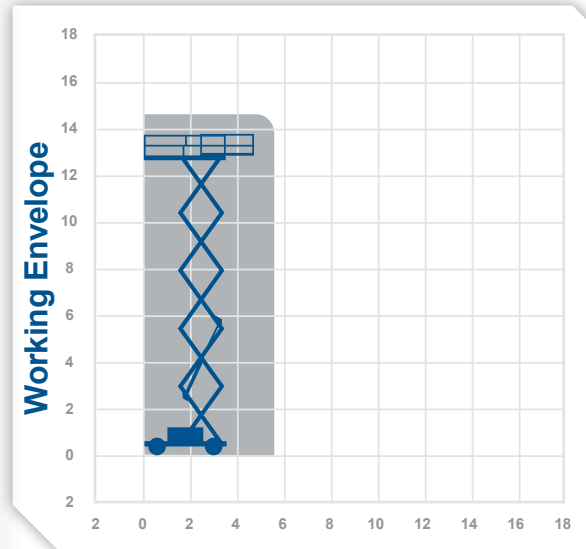

**Nationwide Platforms**  
 A **LOXAM** Company

## Working Height 15.1m

Closed Length	4.88m
Closed Height	2.93m
Stowed Height (guardrails lowered)	2.25m
Closed Width	2.29m
Platform Size	4.81m x 1.83m
Platform Length (deck extended)	7.38m
Max SWL	680kg
Weight	7323kg

### Alternative machines

8841  
9241  
GS53

### Manufacturer

Genie

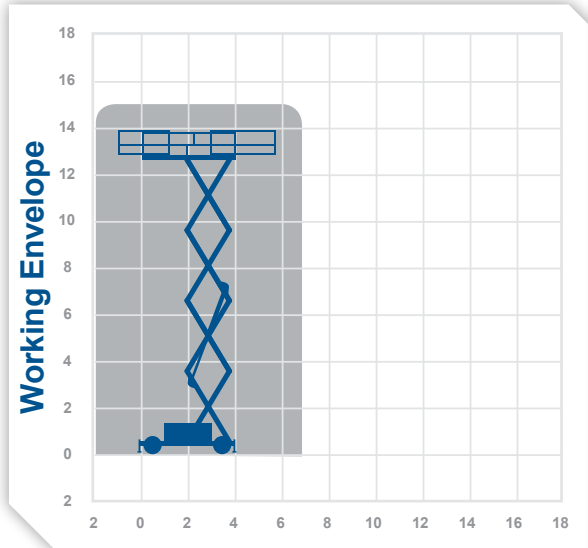

## Working Height 15.1m

Closed Length	4.88m
Closed Height	2.93m
Stowed Height (guardrails lowered)	2.25m
Closed Width	2.29m
Platform Size	4.81m x 1.83m
Platform Length (deck extended)	7.38m
Max SWL	680kg
Weight	7323kg

### Alternative machines

GS53G

### Manufacturer

Genie

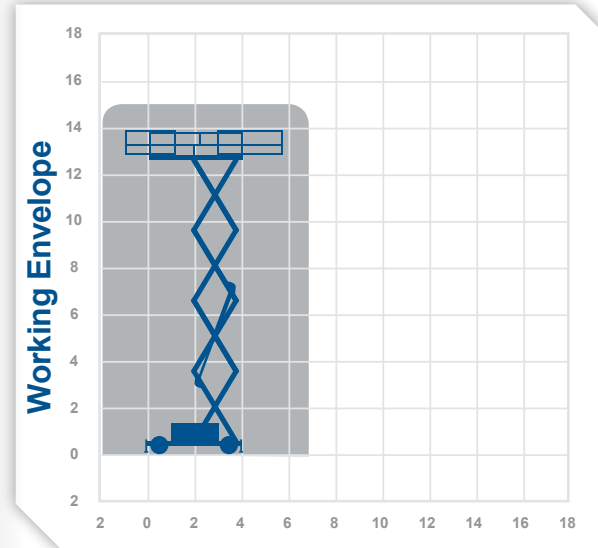

0345 745 0000  
nationwideplatforms.co.uk



**Nationwide Platforms**  
A **LOXAM** Company



# S152-12

# scissors

## Working Height 15.2m

Closed Length	3.35m
Closed Height	3.0m
Stowed Height (guardrails lowered)	2.25m
Closed Width	1.19m
Platform Size	3.04m x 1.18m
Platform Length (deck extended)	4.24m
Max SWL	500kg
Weight	4700kg

### Alternative machines

LL15N  
GS4047  
COM14  
S142-12

### Manufacturer

HAB

Indoor use only

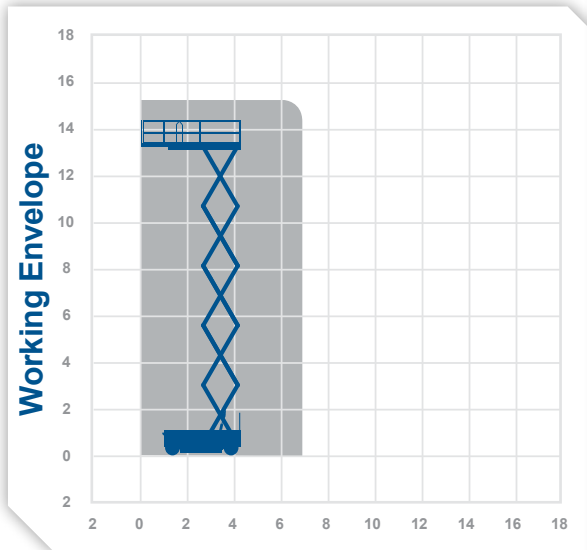

# 9250X

# scissors

## Working Height 17.2m

Closed Length	4.47m
Closed Height	3.16m
Stowed Height (guardrails lowered)	2.29m
Closed Width	2.34m
Platform Size	4.27m x 1.88m
Platform Length (deck extended)	7.2m
Max SWL	681kg
Weight	7395kg

### Alternative machines

9250X-O  
GS53

### Manufacturer

SkyJack

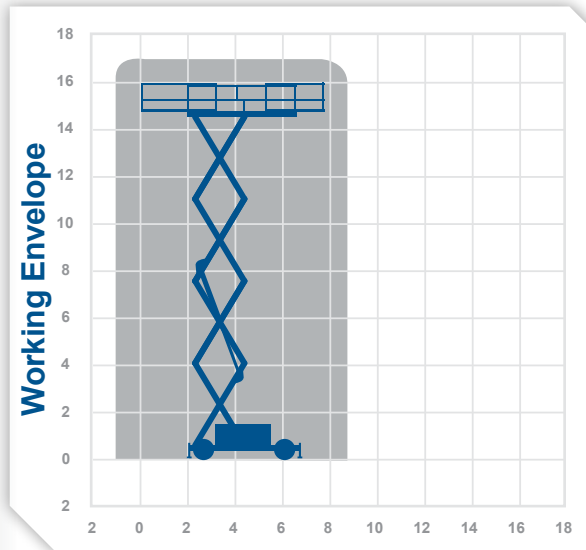

0345 745 0000  
nationwideplatforms.co.uk



**Nationwide Platforms**  
A **LOXAM** Company

# LL15N

## scissors

### Working Height 17.3m

Closed Length	4.12m
Closed Height	3.3m
Stowed Height (guardrails lowered)	2.55m
Closed Width	1.22m
Platform Size	3.9m x 1.2m
Platform Length (deck extended)	5.4m
Max SWL	500kg
Weight	7600kg

#### Alternative machines

S152-12  
S175-12  
165-12  
LL17E

#### Manufacturer

Liftlux

Indoor use only

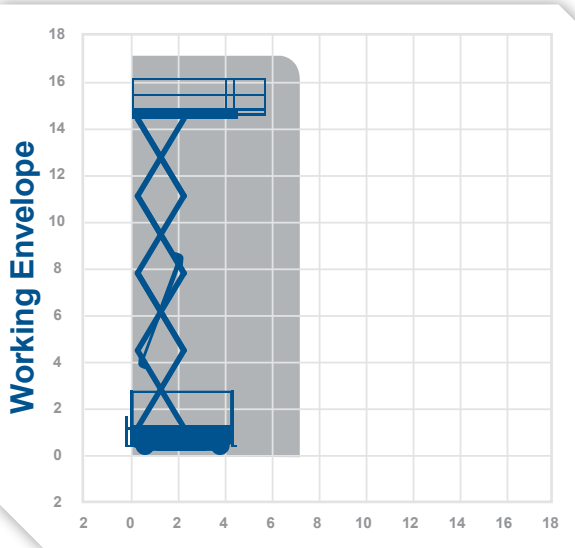

# S175-12

## scissors

### Working Height 17.5m

Closed Length	3.34m
Closed Height	3.15m
Stowed Height (guardrails lowered)	2.38m
Closed Width	1.19m
Platform Size	3.04m x 1.18m
Platform Length (deck extended)	4.25m
Max SWL	500kg
Weight	5350kg

#### Alternative machines

LL15N  
S175-12  
165-12

#### Manufacturer

HAB

Indoor use only

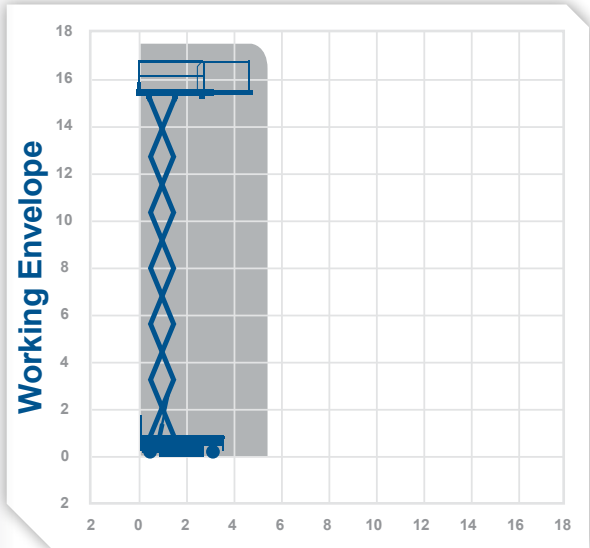

0345 745 0000  
nationwideplatforms.co.uk



**Nationwide Platforms**  
A Loxam Company

### Working Height 18.0m

Closed Length	5.3m
Closed Height	2.99m
Stowed Height (guardrails lowered)	2.11m
Closed Width	2.25m
Platform Size	1.89m x 5.3m
Platform Length (deck extended)	7.3m
Max SWL	500kg
Weight	7360g

#### Alternative machines

GS53

#### Manufacturer

Haulotte

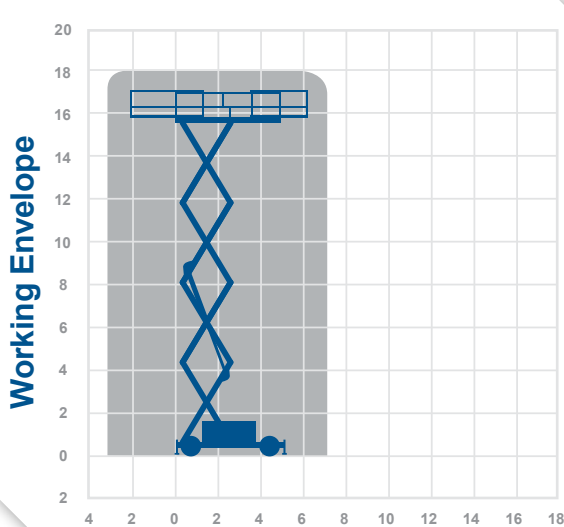

0345 745 0000  
nationwideplatforms.co.uk



### Working Height 18.15m

Closed Length	4.88m
Closed Height	3.15m
Stowed Height (guardrails lowered)	2.47m
Closed Width	2.29m
Platform Size	4.81m x 1.83m
Platform Length (deck extended)	7.38m
Max SWL	680kg
Weight	8050kg

#### Alternative machines

LL20X  
9250X  
9250

#### Manufacturer

Genie

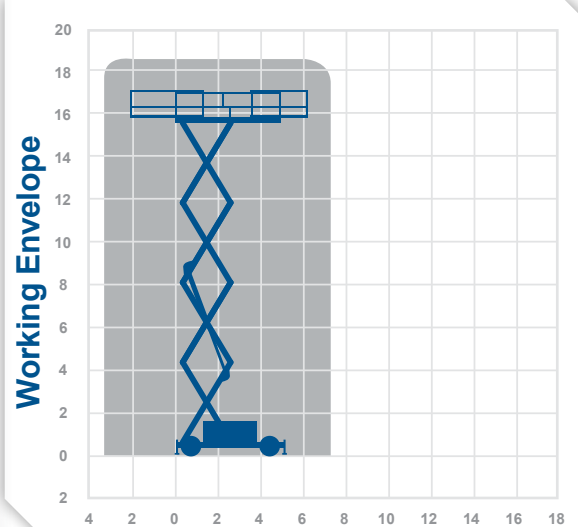

Nationwide Platforms  
A Loxam Company

## Working Height 18.2m

Closed Length	3.98m
Closed Height	3.15m
Stowed Height (guardrails lowered)	2.47m
Closed Width	2.29m
Platform Size	4.81m x 1.83m
Platform Length (deck extended)	7.38m
Max SWL	680kg
Weight	9541kg

### Alternative machines

GS43G

### Manufacturer

Genie

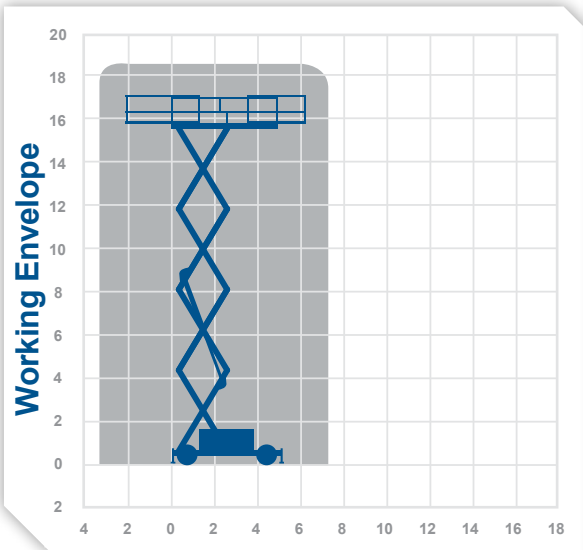

0345 745 0000  
nationwideplatforms.co.uk



## Working Height 18.5m

Closed Length	3.74m
Closed Height	3.4m
Stowed Height (guardrails lowered)	2.65m
Closed Width	1.2m
Platform Size	3.38m x 1.16m
Platform Length (deck extended)	4.88m
Max SWL	500kg
Weight	7985kg

### Alternative machines

LL15N  
S175-12  
180-12  
LL15N

### Manufacturer

Holland Lift

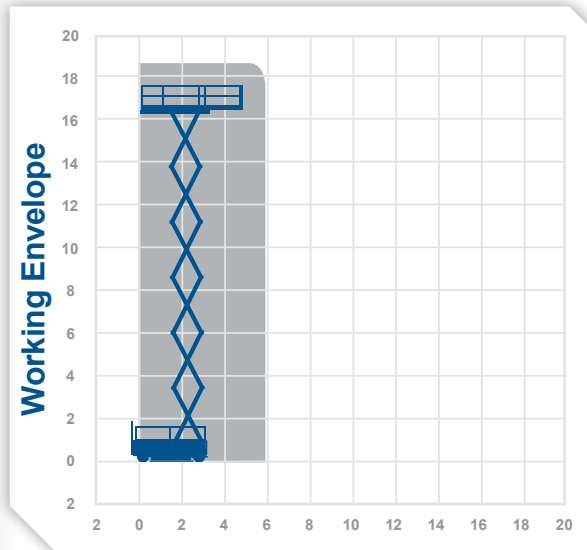

Indoor use only

**Nationwide Platforms**  
A Loxam Company



## Working Height 21.4m

Closed Length	3.74m
Closed Height	3.74m
Stowed Height (guardrails lowered)	3.01m
Closed Width	1.20m
Platform Size	3.38m x 1.16m
Platform Length (deck extended)	4.88m
Max SWL	500kg
Weight	9120kg

### Alternative machines

SL180N

### Manufacturer

Holland Lift

Indoor use only



Working Envelope

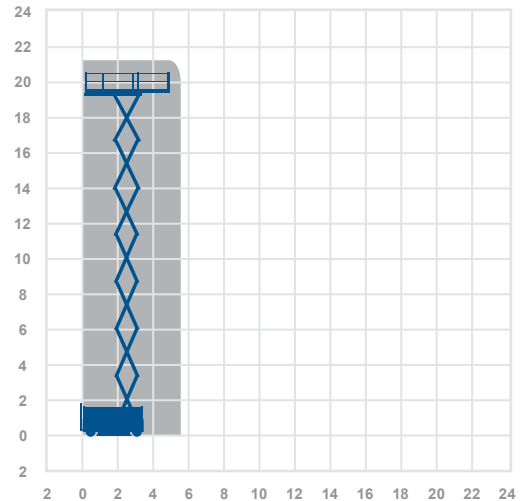

0345 745 0000  
nationwideplatforms.co.uk



**Nationwide Platforms**  
A **LOXAM** Company

# HL220H

## scissors

### Working Height 21.7m

Closed Length	4.84m
Closed Height	3.65m
Stowed Height (guardrails lowered)	2.88m
Closed Width	2.44m
Platform Size	2.30m x 4.50m
Platform Length (deck extended)	7.0m
Max SWL	750kg
Weight	13900g

#### Alternative machines

HL220D  
HL235D  
S225  
LL20X  
SL210  
SL245

#### Manufacturer

Holland Lift

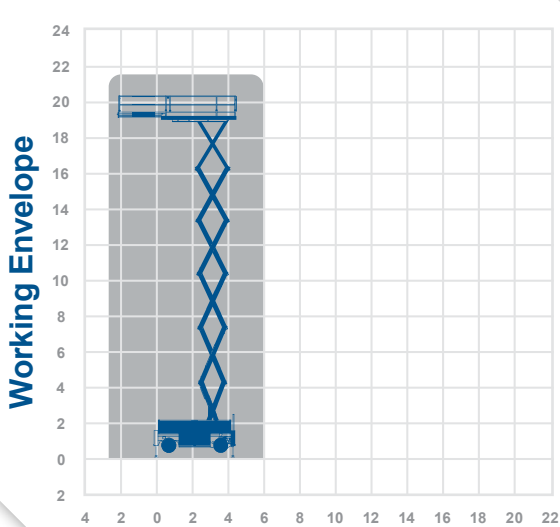

0345 745 0000  
nationwideplatforms.co.uk



# HL220D

## scissors

### Working Height 21.9m

Closed Length	4.84m
Closed Height	3.65m
Stowed Height (guardrails lowered)	2.88m
Closed Width	2.44m
Platform Size	4.50m X 2.30m
Platform Length (deck extended)	7.0m
Max SWL	750kg
Weight	12140kg

#### Alternative machines

LL20X  
LL26X  
HL235D  
SL210

#### Manufacturer

Holland Lift

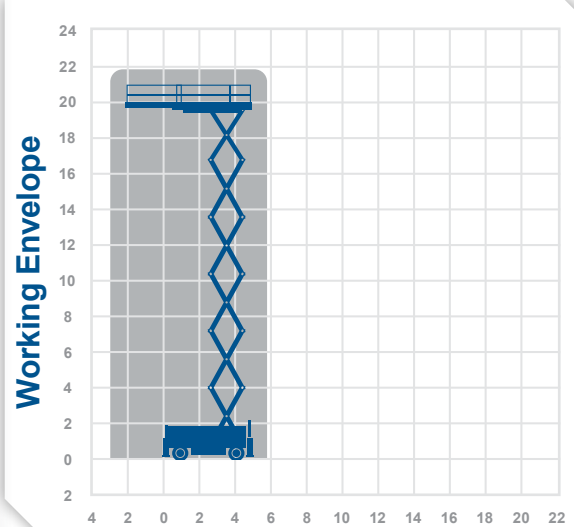

 Nationwide Platforms  
A Loxam Company

# S225-24

# scissors

## Working Height 22.5m

Closed Length	4.84m
Closed Height	3.72m
Stowed Height (guardrails lowered)	2.88m
Closed Width	2.39m
Platform Size	4.5m x 2.36m
Platform Length (deck extended)	7.2m
Max SWL	750kg
Weight	11000kg

### Alternative machines

LL20X  
LL26X  
HL220D  
HL235D

### Manufacturer

HAB

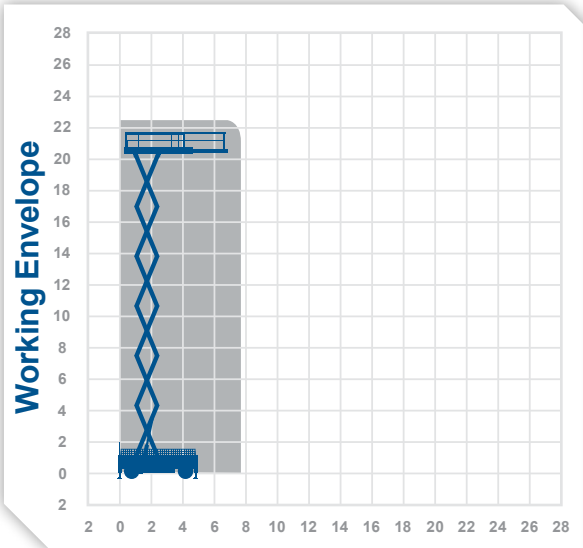

# SL210

# scissors

## Working Height 23.0m

Closed Length	5.75m
Closed Height	4.1m
Stowed Height (guardrails lowered)	3.2m
Closed Width	2.5m
Platform Size	5.35m x 2.50m
Platform Length (deck extended)	7.55m
Max SWL	1000kg
Weight	15000kg

### Alternative machines

LL20X  
HL220D  
HL235D  
S225-24

### Manufacturer

Liftlux

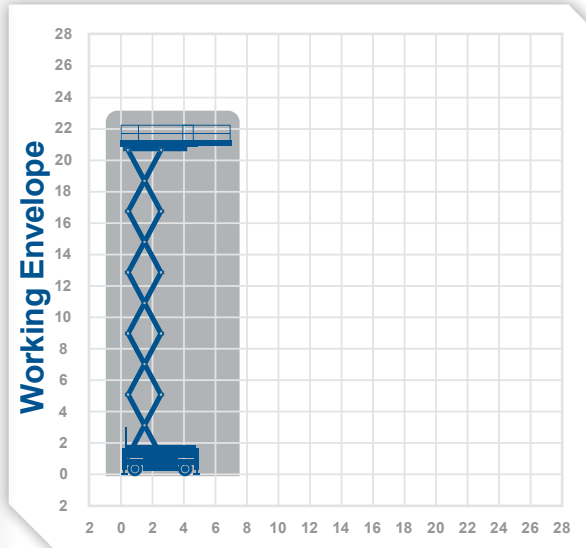

0345 745 0000  
nationwideplatforms.co.uk



**Nationwide Platforms**  
A Loxam Company

# HL235D

## scissors

### Working Height 23.2m

Closed Length	5.75m
Closed Height	4.01m
Stowed Height (guardrails lowered)	3.1m
Closed Width	2.49m
Platform Size	5.22m x 2.40m
Platform Length (deck extended)	7.32m
Max SWL	1000kg
Weight	18100kg

#### Alternative machines

LL20X  
S225-24  
SL210  
HL220D

#### Manufacturer

Holland Lift

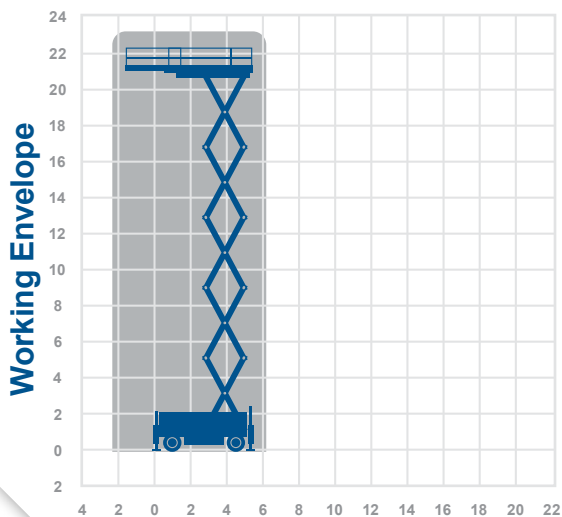

# M250

## scissors

### Working Height 27.0m

Closed Length	6.57m
Closed Height	3.89m
Stowed Height (guardrails lowered)	3.13m
Closed Width	2.65m
Platform Size	6.15m x 2.5m
Platform Length (deck extended)	8.25m
Max SWL	1000kg
Weight	21910kg

#### Alternative machines

LL26X  
SL245

#### Manufacturer

Holland Lift

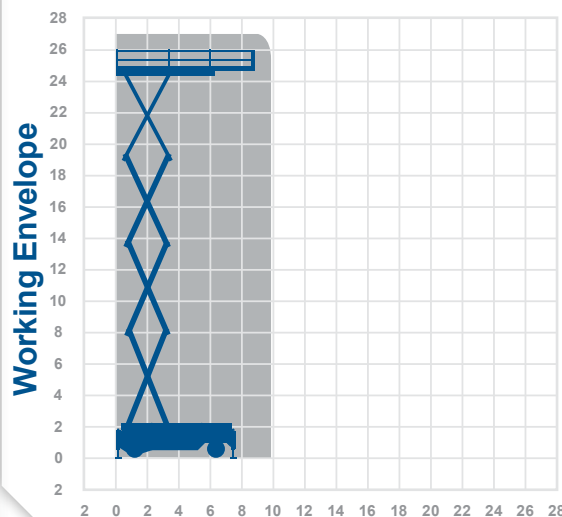

0345 745 0000  
nationwideplatforms.co.uk



**Nationwide Platforms**  
A **LOXAM** Company



# HL275H

## scissors

### Working Height 27.2m

Closed Length	6.57m
Closed Height	3.89m
Stowed Height (guardrails lowered)	3.13m
Closed Width	2.5m
Platform Size	2.35m x 6.15m
Platform Length (deck extended)	8.25m
Max SWL	1000kg
Weight	25100kg

#### Alternative machines

M250  
LL26X  
S280

#### Manufacturer

Holland Lift

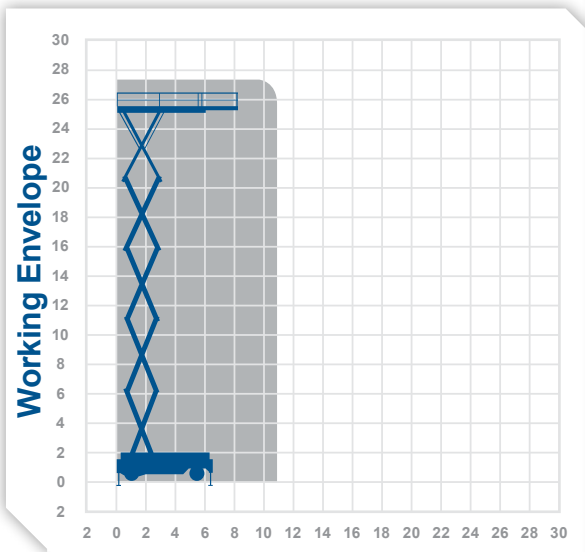

# S280-25

## scissors

### Working Height 28.0m

Closed Length	5.96m
Closed Height	4.1m
Stowed Height (guardrails lowered)	3.4m
Closed Width	2.5m
Platform Size	5.48m x 2.44m
Platform Length (deck extended)	7.57m
Max SWL	750kg
Weight	18000kg

#### Alternative machines

LL26X

#### Manufacturer

HAB

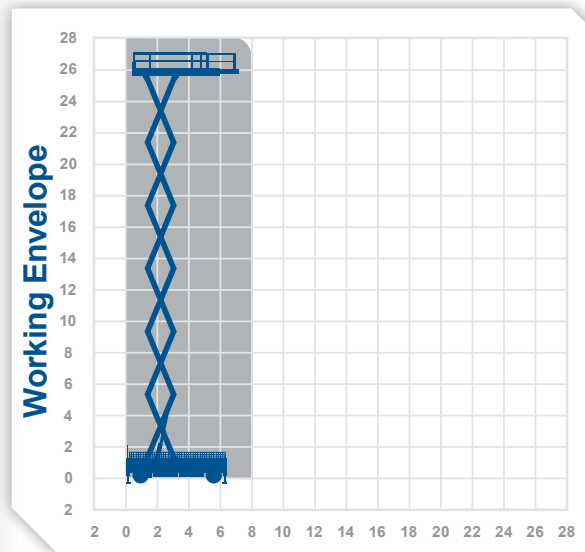

0345 745 0000  
nationwideplatforms.co.uk



**Nationwide Platforms**  
A **LOXAM** Company

# LL26X

## scissors

### Working Height 28.3m

Closed Length	7.15m
Closed Height	4.2m
Stowed Height (guardrails lowered)	3.1m
Closed Width	2.5m
Platform Size	6.7m x 2.5m
Platform Length (deck extended)	9.8m
Max SWL	1000kg
Weight	25000kg

#### Alternative machines

M250  
SL245  
S280-25

#### Manufacturer

Liftlux

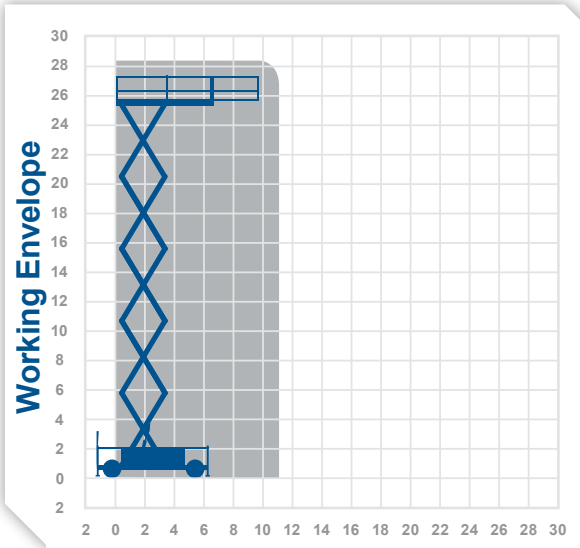

0345 745 0000  
nationwideplatforms.co.uk

# HL340D

## scissors

### Working Height 33.5m

Closed Length	7.02m
Closed Height	3.63m
Stowed Height (guardrails lowered)	2.87m
Closed Width	2.98m
Platform Size	6.66m x 2.80m
Platform Length (deck extended)	9.66m
Max SWL	1000kg
Weight	31350kg

#### Alternative machines

S280-25  
LL26X

#### Manufacturer

Holland Lift

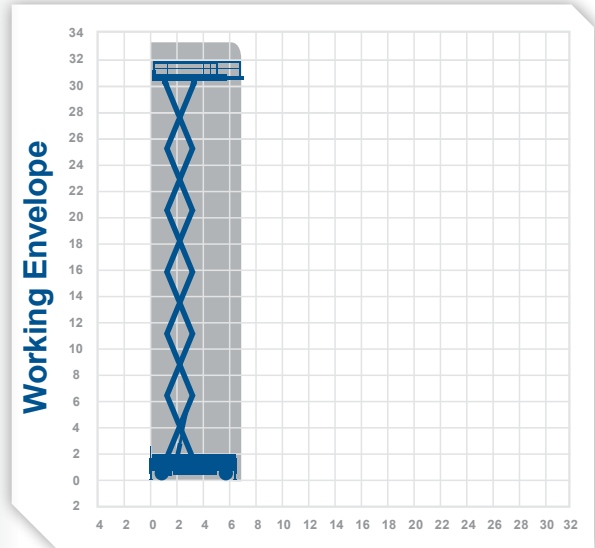

Nationwide Platforms  
A Loxam Company



# Boom Lifts



- More than 6,100 units available to hire across the UK
- Working heights from 10m to 56m
- Variety of power options
- Narrow aisle machines
- Telescopic or articulating action
- Rough terrain tyre option
- Non-marking tyres for use on finished floors

## Machine type by product code

Star10	Z45BJ	Z80
Star10A	Z45EJ	HA260PX
Z30N	HA16PX	80JX
G30N	HA16RTJ	G85X
30JP	Z4525DJX	S85
HA12CJ	SJ46AJ	HR28H
Z33E	HR17H	860SJ
HR12NBS	TITAN60	HA32PX
G34N	Z60FE	1200SJP
G34DX	60AJX	1250AJP
40NJ	G60X	S125
HA15IP	HA20RTJPRO	HA41RTJPRO
HR15NBS	HA20PX	Z135
HR15NH	HR21H	ZX135
Z45DJX	HR21D	SX135HC
45MJ	Z62	1350SJP
S45X	S65X	SX150
45JSX	66JX	1500AJP
Z45DJXC	HT23RTJ	SX180

**0345 745 0000**  
**nationwideplatforms.co.uk**



**Nationwide Platforms**  
 A **LOXAM** Company

# Star10

booms

**Working Height 10.0m**  
**Horizontal Outreach 3.0m**

Closed Length 2.62m  
Closed Height 1.99m  
Closed Width 1.0m  
Platform Size 0.9m x 0.7m  
Rotation 360°  
Max SWL 200kg  
Weight 2760kg

Alternative machines

Star10 A

Manufacturer

Haulotte

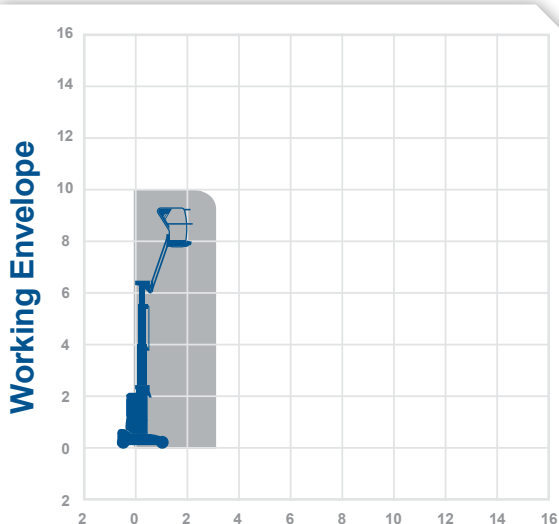

# Star10 A

booms

**Working Height 10.0m**  
**Horizontal Outreach 3.0m**

Closed Length 2.7m  
Closed Height 1.99m  
Closed Width 1.0m  
Platform Size 0.98m x 0.78  
Rotation 345°  
Max SWL 200kg  
Weight 2677kg

Alternative machines

Star10

Manufacturer

Haulotte

fitted with  
manufacturers  
secondary guarding  
as standard

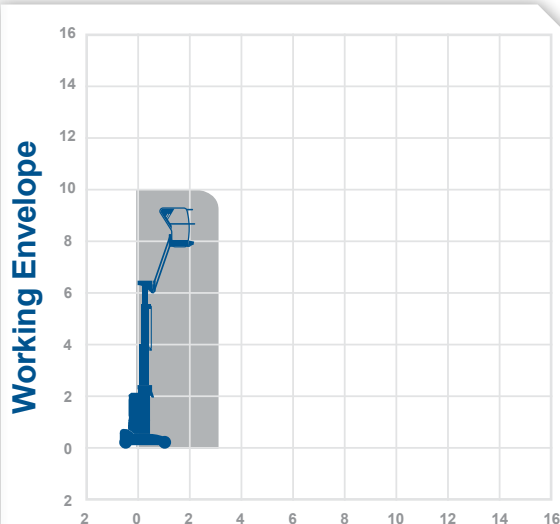

0345 745 0000  
nationwideplatforms.co.uk



**Nationwide Platforms**  
A **LOXAM** Company



**Working Height 10.89m**  
**Horizontal Outreach 6.25m**

Closed Length	5.31m
Closed Height	2.0m
Closed Width	1.19m
Platform Size	1.17m x 0.76m
Rotation	355°
Max SWL	227kg
Weight	6450kg

**Alternative machines**

30JP  
 30J  
 40NJ  
 G30N

**Manufacturer**

Genie

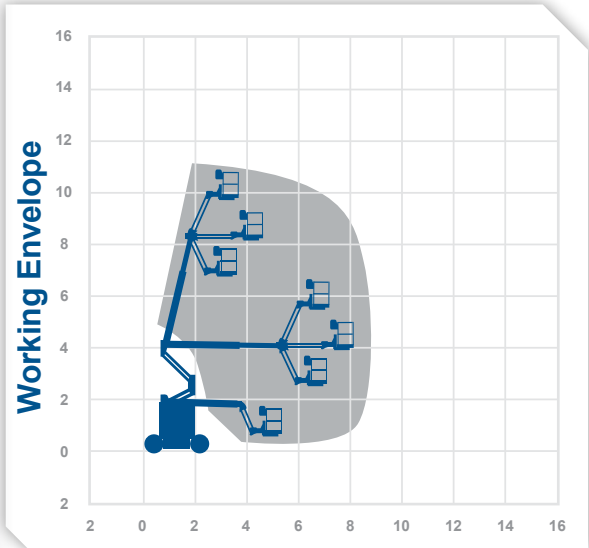

**0345 745 0000**  
 nationwideplatforms.co.uk



**Nationwide Platforms**  
 A **LOXAM** Company

## Working Height 11.0m Horizontal Outreach 6.4m

Closed Length	5.2m
Closed Height	2.0m
Closed Width	1.2m
Platform Size	1.17m x 0.76m
Rotation	355°
Max SWL	227kg
Weight	6577kg

### Alternative machines

30JP  
Z30N

### Manufacturer

Genie

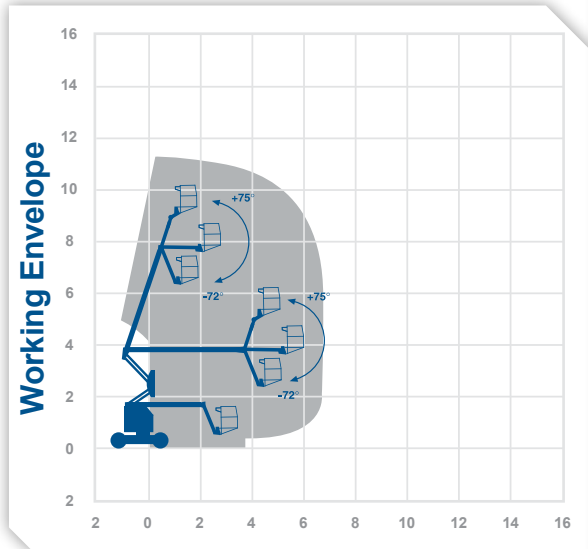

0345 745 0000  
nationwideplatforms.co.uk

## Working Height 11.14m Horizontal Outreach 6.25m

Closed Length	5.59m
Closed Height	2.0m
Closed Width	1.22m
Platform Size	1.22m x 0.76m
Rotation	140°
Max SWL	227kg
Weight	6849kg

### Alternative machines

G30N  
Z30N  
30J

### Manufacturer

JLG

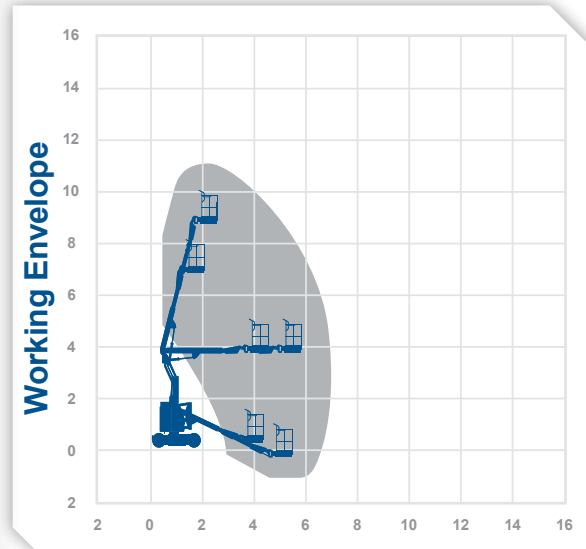

Nationwide Platforms  
A Loxam Company



**Working Height 11.68m**  
**Horizontal Outreach 6.94m**

Closed Length	5.36m
Closed Height	1.99m
Closed Width	1.2m
Platform Size	1.14m x 0.80m
Rotation	355°
Max SWL	250kg
Weight	7065kg

**Alternative machines**

G30N  
Z30N  
30JP

**Manufacturer**

Haulotte

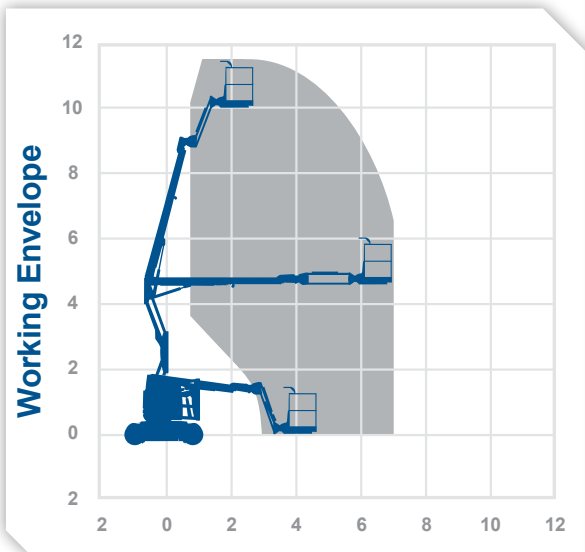

**0345 745 0000**  
**nationwideplatforms.co.uk**



**Working Height 12.0m**  
**Horizontal Outreach 5.57m**

Closed Length	4.17m
Closed Height	1.98m
Closed Width	1.5m
Platform Size	1.16m x 0.76m
Rotation	400°
Max SWL	200kg
Weight	3665kg

**Alternative machines**

HR12NB  
HR12NBS

**Manufacturer**

Genie

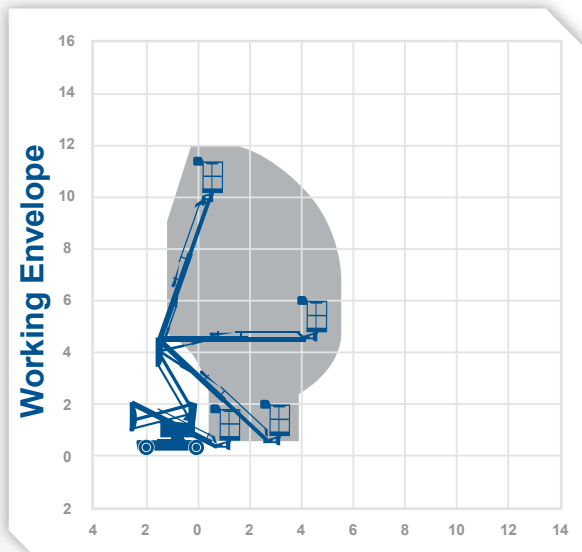

**Nationwide Platforms**  
 A **LOXAM** Company

**Working Height** 12.2m

**Horizontal Outreach** 6.1m

Closed Length	4.1m
Closed Height	1.9m
Closed Width	1.5m
Platform Size	1.10m x 0.65m
Rotation	360°
Max SWL	200kg
Weight	3435kg

**Alternative machines**

40NJ  
HR15NB  
HR12NB

**Manufacturer**

Niftylift

fitted with manufacturers secondary guarding as standard

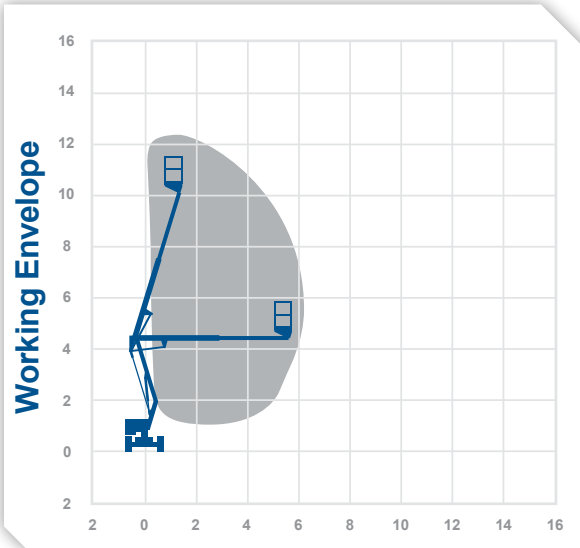

**0345 745 0000**  
[nationwideplatforms.co.uk](http://nationwideplatforms.co.uk)

**Working Height** 12.52m

**Horizontal Outreach** 6.78m

Closed Length	5.72m
Closed Height	2.0m
Closed Width	1.47m
Platform Size	1.42m x 0.76m
Rotation	355°
Max SWL	227kg
Weight	5171kg

**Alternative machines**

HR12NB  
Z33  
G34E  
HR12NB

**Manufacturer**

Genie

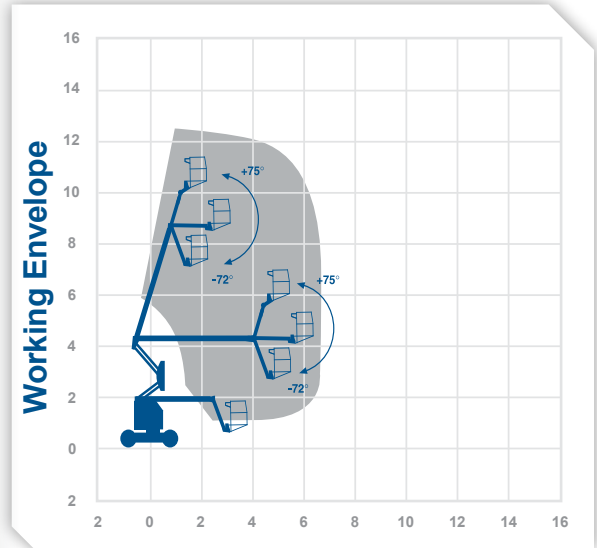

**Nationwide Platforms**  
A **LOXAM** Company





# G34DX

## booms

**Working Height** 12.62m  
**Horizontal Outreach** 6.78m

Closed Length 5.66m  
Closed Height 2.06m  
Closed Width 1.85m  
Platform Size 1.42m x 0.76m  
Rotation 355°  
Max SWL 227kg  
Weight 4929kg

Alternative machines

G34D

Manufacturer

Genie

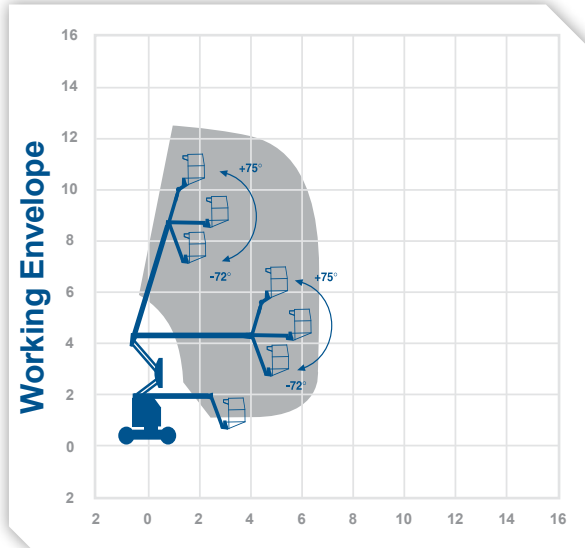

**0345 745 0000**  
[nationwideplatforms.co.uk](http://nationwideplatforms.co.uk)

# 40NJ

## booms

**Working Height** 14.19m  
**Horizontal Outreach** 6.83m

Closed Length 6.71m  
Closed Height 1.97m  
Closed Width 1.5m  
Platform Size 1.22m x 0.76m  
Rotation 360°  
Max SWL 230kg  
Weight 6759kg

Alternative machines

HR15NB  
Z45BJ

Manufacturer

JLG

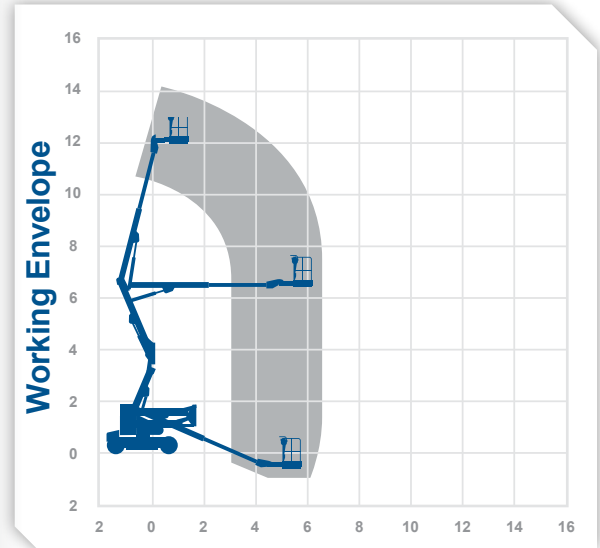

**Nationwide Platforms**  
A **LOXAM** Company



# HA15IP

## booms

**Working Height** 14.87m  
**Horizontal Outreach** 8.65m

Closed Length 6.65m  
 Closed Height 2.1m  
 Closed Width 1.52m  
 Platform Size 1.15m x 0.80m  
 Rotation 355°  
 Max SWL 230kg  
 Weight 7230kg

### Alternative machines

HR15NBS  
 HR15NH

### Manufacturer

Haulotte

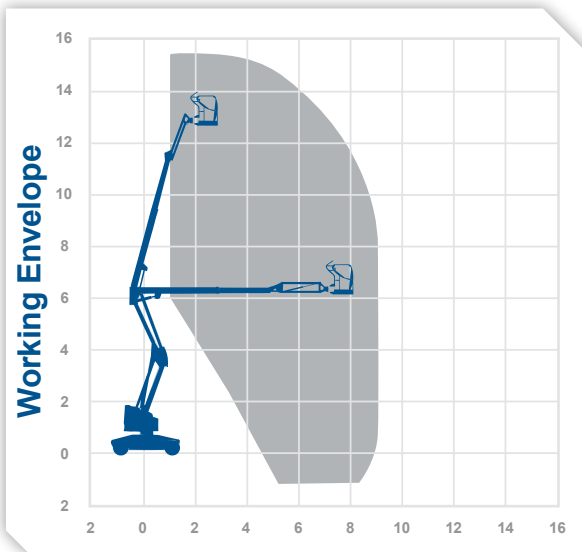

**0345 745 0000**  
[nationwideplatforms.co.uk](http://nationwideplatforms.co.uk)

# HR15NBS

## booms

**Working Height** 15.4m  
**Horizontal Outreach** 9.6m

Closed Length 6.3m  
 Closed Height 2.1m  
 Closed Width 1.5m  
 Platform Size 1.5m x 0.7m  
 Rotation 360°  
 Max SWL 225kg  
 Weight 6680kg

### Alternative machines

40NJ  
 Z45BJ  
 HR15NB

### Manufacturer

Niftylift

fitted with manufacturers secondary guarding as standard

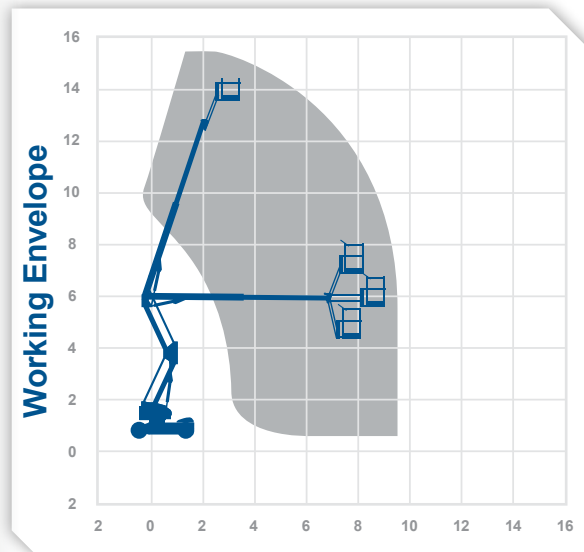

**Nationwide Platforms**  
 A **LOXAM** Company



# HR15NH

booms

**Working Height 15.5m**  
**Horizontal Outreach 9.7m**

Closed Length 6.4m  
Closed Height 1.99m  
Closed Width 1.5m  
Platform Size 1.5m x 0.8m  
Rotation 360°  
Max SWL 225kg  
Weight 7250kg

**Alternative machines**

HR15NBS

**Manufacturer**

Niftylift

fitted with manufacturers secondary guarding as standard

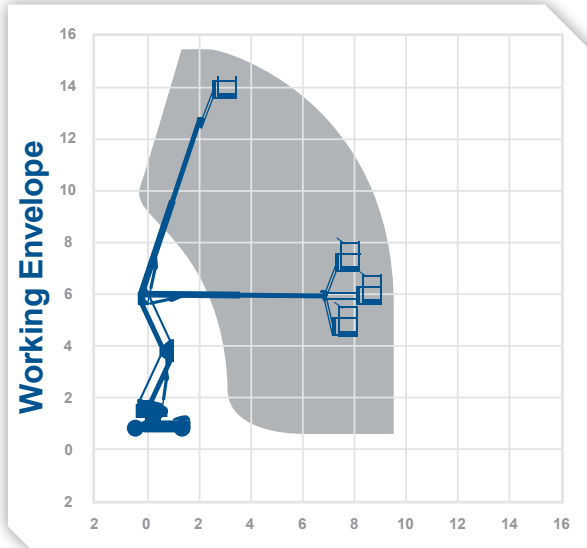

**0345 745 0000**  
**nationwideplatforms.co.uk**

# Z45DJX

booms

**Working Height 15.69m**  
**Horizontal Outreach 7.6m**

Closed Length 6.78m  
Closed Height 2.08m  
Closed Width 2.23m  
Platform Size 1.82m x 0.76m  
Rotation 359°  
Max SWL 227kg  
Weight 6542kg (Air)  
6892kg (Foam Filled)

**Alternative machines**

Z45D  
Z45D-R  
Z4525DJX

**Manufacturer**

Genie

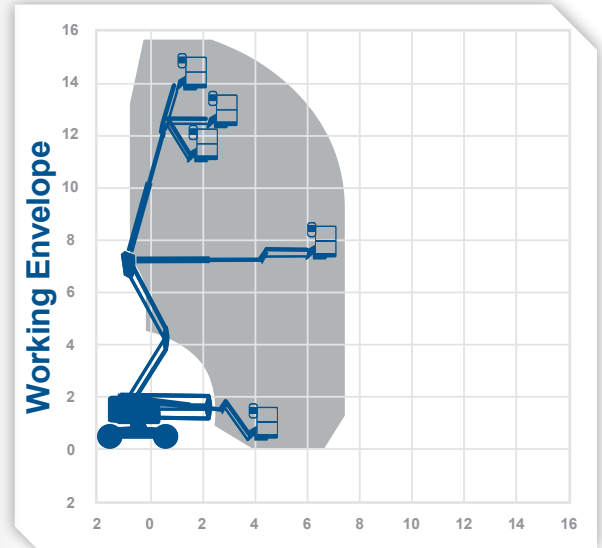

**Nationwide Platforms**  
A **LOXAM** Company



# 45MJ

# booms

## Working Height 15.72m Horizontal Outreach 7.24m

Closed Length	6.5m
Closed Height	2.01m
Closed Width	1.75m
Platform Size	1.52m x 0.76m
Rotation	360°
Max SWL	230kg
Weight	6532kg

### Alternative machines

HR15NBS  
Z45BJ  
45MJP

### Manufacturer

JLG

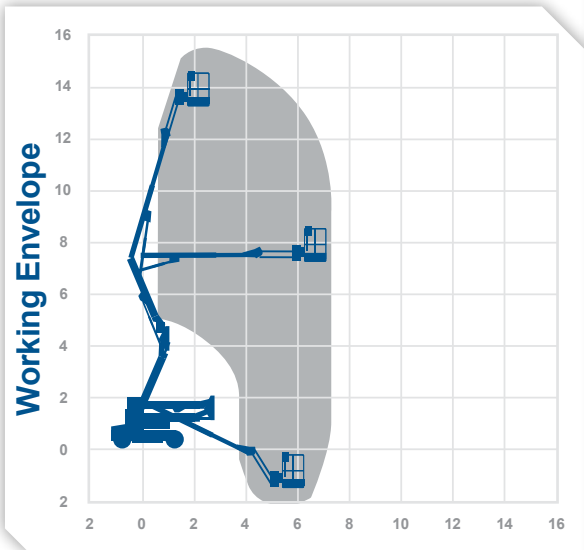

# S45X

# booms

## Working Height 15.72m Horizontal Outreach 11.18m

Closed Length	8.48m
Closed Height	2.49m
Closed Width	2.3m
Platform Size	1.83m x 0.76m
Rotation	Continuous
Max SWL	227kg
Weight	6709kg
Reach Below Ground	1.5m

### Manufacturer

Genie

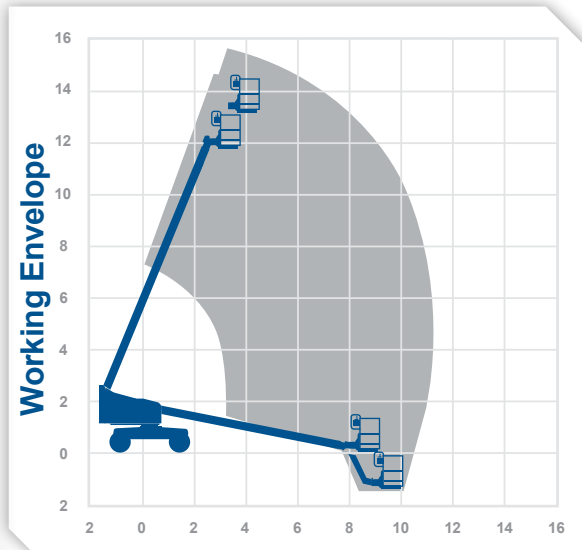

0345 745 0000  
nationwideplatforms.co.uk



**Nationwide Platforms**  
A **LOXAM** Company

# 45JSX

## booms

**Working Height** 15.72m  
**Horizontal Outreach** 7.47m

Closed Length 6.58m  
 Closed Height 2.27m  
 Closed Width 2.35m  
 Platform Size 1.83m x 0.76m  
 Rotation 355°  
 Max SWL 230kg  
 Weight 7484kg

### Alternative machines

HA16SPX  
 Z45DJX

### Manufacturer

JLG

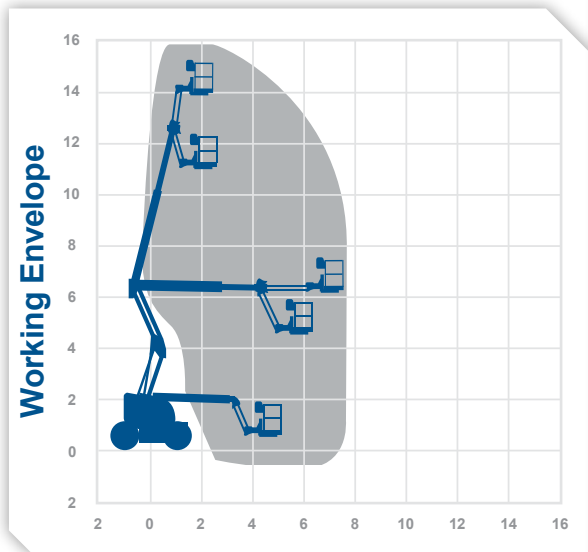

0345 745 0000  
 nationwideplatforms.co.uk



# Z45DJXC

## booms

**Working Height** 15.86m  
**Horizontal Outreach** 7.55m

Closed Length 6.66m  
 Closed Height 2.25m  
 Closed Width 2.29m  
 Platform Size 1.83m x 0.76m  
 Rotation 355°  
 Max SWL 454kg  
 Weight 6984kg

### Alternative machines

Z45DJX  
 45JSX  
 HA16SPX

### Manufacturer

Genie

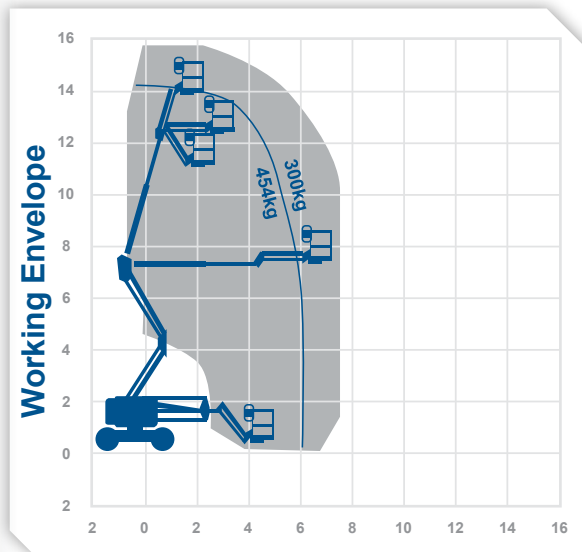

**Nationwide Platforms**  
 A Loxam Company

# Z45BJ

## booms

**Working Height 15.94m**  
**Horizontal Outreach 7.65m**

Closed Length 6.83m  
 Closed Height 2.0m  
 Closed Width 1.79m  
 Platform Size 1.83m x 0.76m  
 Rotation 355°  
 Max SWL 227kg  
 Weight 7620kg

Alternative machines

Z45EJ

Manufacturer

Genie

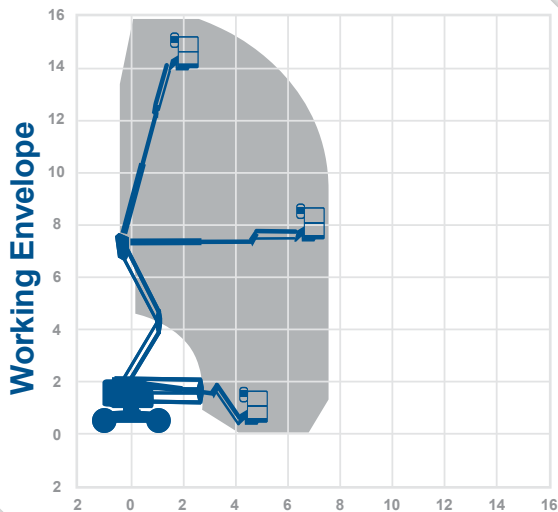

**0345 745 0000**  
**nationwideplatforms.co.uk**

# Z45EJ

## booms

**Working Height 15.94m**  
**Horizontal Outreach 7.65m**

Closed Length 6.83m  
 Closed Height 2.0m  
 Closed Width 1.79m  
 Platform Size 1.83m x 0.76m  
 Rotation 355°  
 Max SWL 227kg  
 Weight 7394kg

Alternative machines

45EJ  
 Z45E  
 45EJ

Manufacturer

Genie

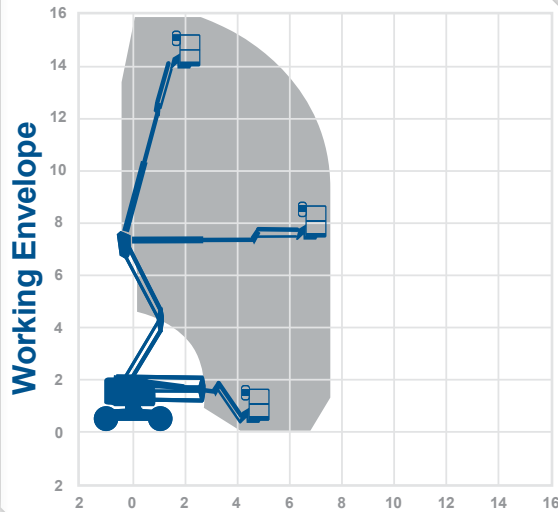

**Nationwide Platforms**  
 A **LOXAM** Company



# HA16PX

booms

**Working Height 16.0m**

**Horizontal Outreach 9.15m**

Closed Length 6.95m  
 Closed Height 2.3m  
 Closed Width 2.3m  
 Platform Size 1.8m x 0.8m  
 Rotation 360°  
 Max SWL 230kg  
 Weight 6950kg

**Alternative machines**

Z4525DJX  
45JSX  
SJ46AJ

**Manufacturer**  
Haulotte

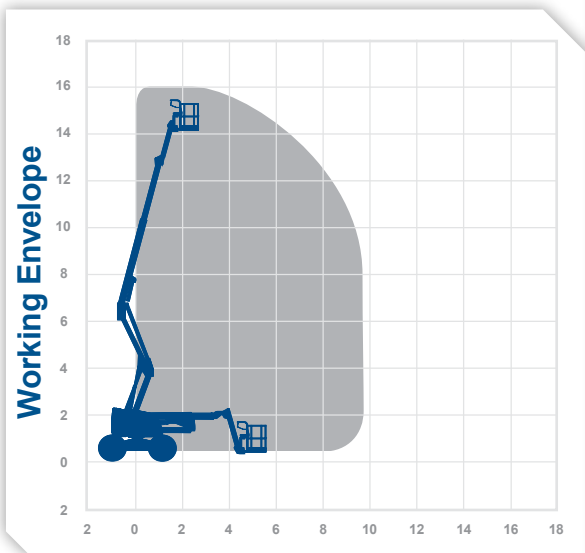

**0345 745 0000**  
[nationwideplatforms.co.uk](http://nationwideplatforms.co.uk)

# HA16RTJ

booms

**Working Height 16.0m**

**Horizontal Outreach 8.3m**

Closed Length 6.75m  
 Closed Height 2.3m  
 Closed Width 2.3m  
 Platform Size 1.83m x 0.8m  
 Rotation 355°  
 Max SWL 230kg  
 Weight 6200kg

**Alternative machines**

Z4525DJX  
45JSX  
SJ46AJ

**Manufacturer**  
Haulotte

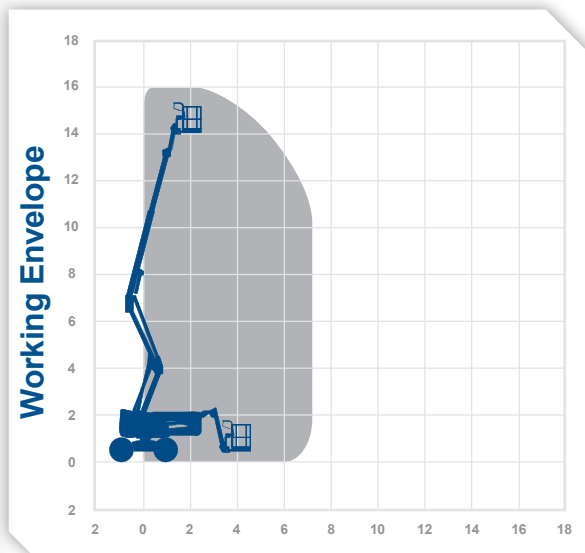

**Nationwide Platforms**  
 A **LOXAM** Company



# Z4525DJX

booms

**Working Height 16.05m**  
**Horizontal Outreach 7.52m**

Closed Length 6.65m  
Closed Height 2.13m  
Closed Width 2.29m  
Platform Size 1.83m x 0.76m  
Rotation 355°  
Max SWL 227kg  
Weight 6574kg

**Alternative machines**

Z45DJX  
45JSX

**Manufacturer**

Genie

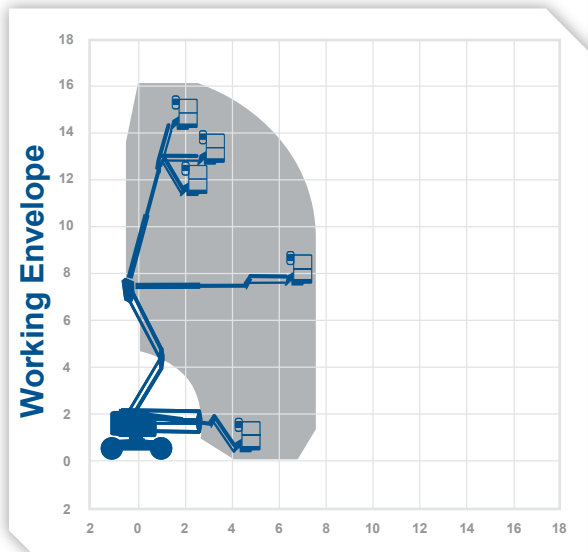

**0345 745 0000**  
**nationwideplatforms.co.uk**

# SJ46AJ

booms

**Working Height 16.1m**  
**Horizontal Outreach 7.54m**

Closed Length 6.5m  
Closed Height 2.07m  
Closed Width 2.29m  
Platform Size 1.83m x 0.76m  
Rotation 360°  
Max SWL 227kg  
Weight 6500kg

**Alternative machines**

Z4525DJX  
Z45DJX  
45JSX  
160ATJ

**Manufacturer**

Skyjack

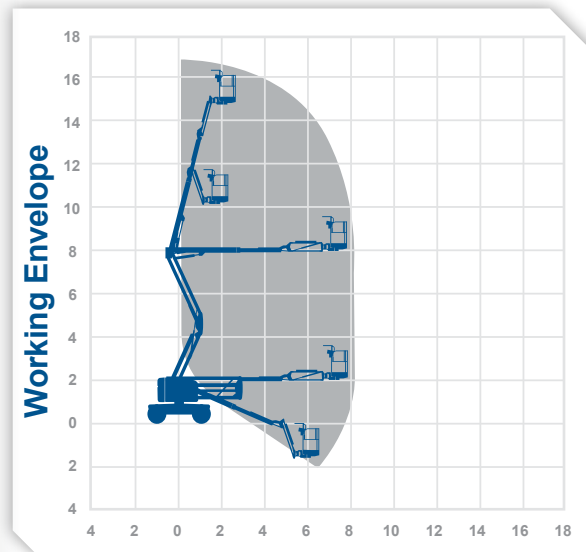

**Nationwide Platforms**  
A **LOXAM** Company





# HR17H

booms

**Working Height 17.2m**  
**Horizontal Outreach 9.4m**

Closed Length 6.35m  
Closed Height 2.1m  
Closed Width 2.0m  
Platform Size 1.8m x 0.85m  
Rotation 360°  
Max SWL 225kg  
Weight 5000kg

Alternative machines

HR21H

Manufacturer

Niftylift

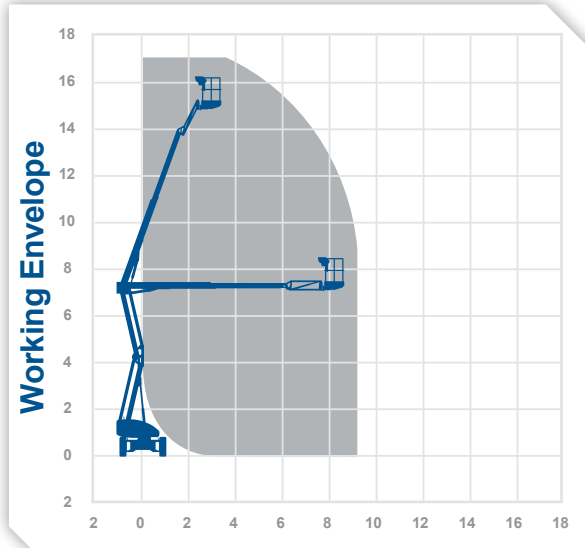

**0345 745 0000**  
**nationwideplatforms.co.uk**

# TITAN60

booms

**Working Height 20.0m**  
**Horizontal Outreach 14.6m**

Closed Length 7.0m  
Closed Height 3.4m  
Closed Width 2.6m  
Width (stabilisers down) 3.7m  
Platform Size 6.7m x 2.28m  
Rotation 180°  
Max SWL 1350kg  
Weight 18000kg

Alternative machines

TITAN40

Manufacturer

MEC

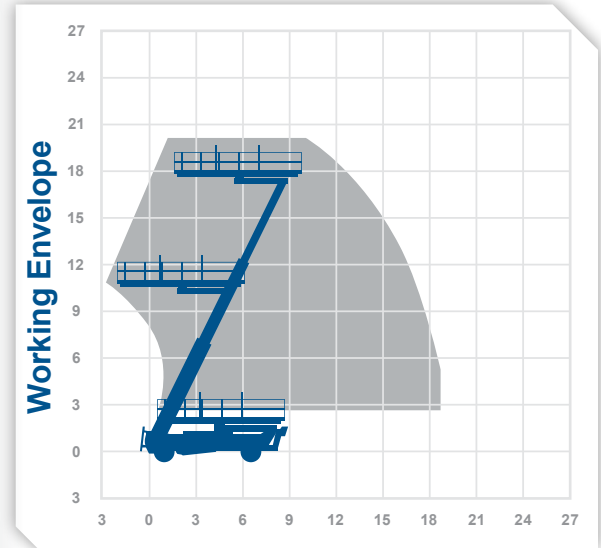

**Nationwide Platforms**  
A **LOXAM** Company



# Z60FE

## booms

**Working Height** 20.16m  
**Horizontal Outreach** 11.15m

Closed Length 8.15m  
 Closed Height 2.54m  
 Closed Width 2.49m  
 Platform Size 1.83m x 0.76m  
 Rotation 355°  
 Max SWL 227kg  
 Weight 7756kg

### Alternative machines

HR21H

### Manufacturer

Genie

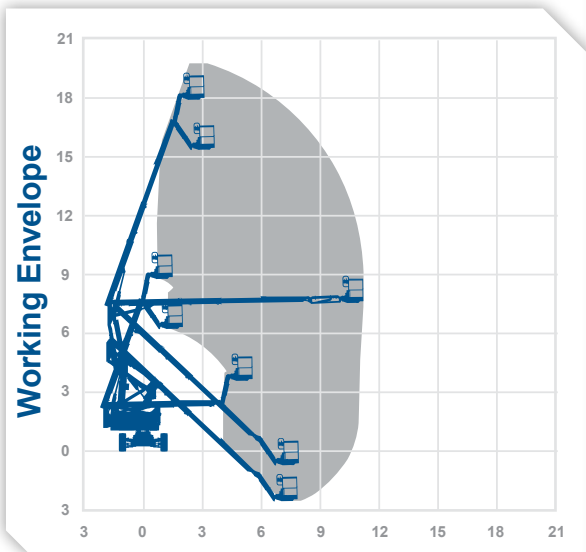

# 60AJX

## booms

**Working Height** 20.29m  
**Horizontal Outreach** 12.12m

Closed Length 8.82m  
 Closed Height 2.56m  
 Closed Width 2.44m  
 Platform Size 1.83m x 0.91m  
 Rotation 180°  
 Max SWL 227kg  
 Weight 10650kg

### Alternative machines

Z62  
 G60X  
 HR21D  
 60AJ  
 60AJX-P

### Manufacturer

JLG

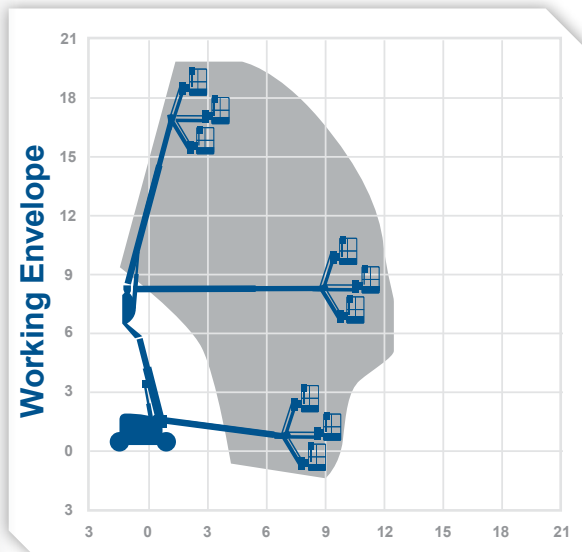

0345 745 0000  
 nationwideplatforms.co.uk



**Nationwide Platforms**  
 A Loxam Company

### Working Height **20.39m** Horizontal Outreach **11.05m**

Closed Length	8.15m
Closed Height	2.69m
Closed Width	2.46m
Platform Size	1.83m x 0.76m
Rotation	Continuous
Max SWL	227kg
Weight	10,025kg (Air) 10,765kg (Foam Filled)

#### Alternative machines

G60-R  
HR21D  
60HJX  
Z62

#### Manufacturer

Genie

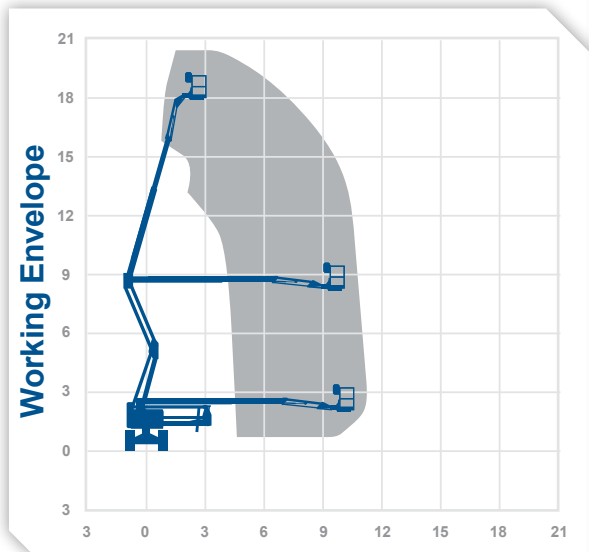

### Working Height **20.6m** Horizontal Outreach **12.2m**

Closed Length	8.8m
Closed Height	2.51m
Closed Width	2.42m
Platform Size	1.83m x 0.80m
Rotation	Continuous
Max SWL	230kg
Weight	9600kg

#### Alternative machines

G60X  
HA260PX  
HR21D

#### Manufacturer

Haulotte

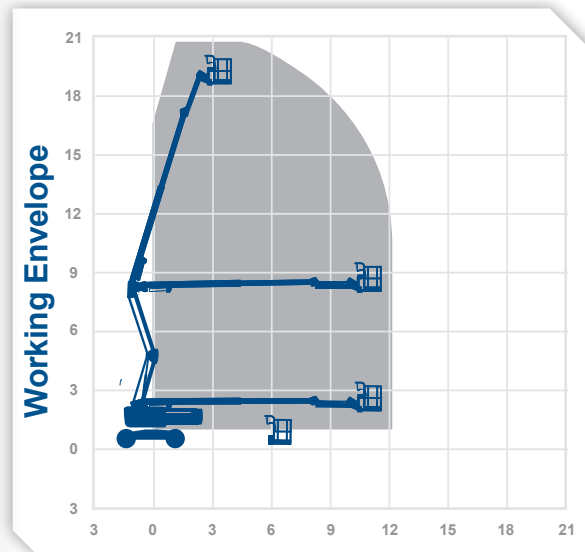

**0345 745 0000**  
[nationwideplatforms.co.uk](http://nationwideplatforms.co.uk)



**Nationwide Platforms**  
A **LOXAM** Company

**Working Height 20.65m**  
**Horizontal Outreach 13.5m**  
**Outreach**

Closed Length 8.93m  
 Closed Height 2.67m  
 Closed Width 2.38m  
 Platform Size 1.8m x 0.8m  
 Rotation 360°  
 Max SWL 230kg  
 Weight 11710kg

Alternative machines

G60X

Manufacturer

Haulotte

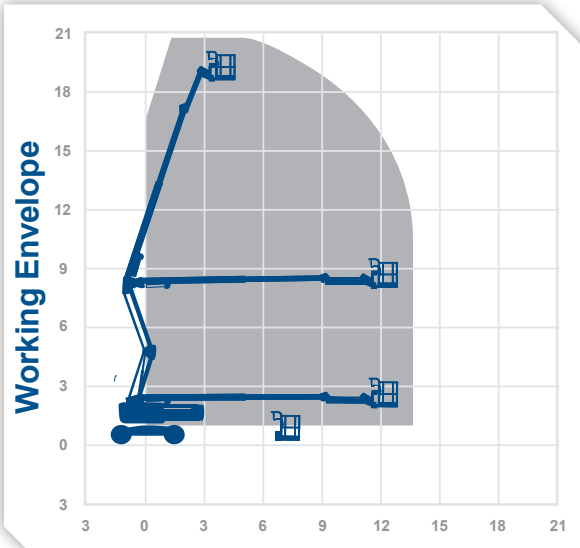

**0345 745 0000**  
**nationwideplatforms.co.uk**



**Nationwide Platforms**  
 A **LOXAM** Company

# HR21H

booms

**Working Height** 20.8m  
**Horizontal Outreach** 12.5m

Closed Length 5.3m  
Closed Height 2.15m  
Closed Width 2.27m  
Platform Size 1.80m x 0.85m  
Rotation 360°  
Max SWL 225kg  
Weight 6500kg

Alternative machines

M60J  
HR21B

Manufacturer

Niftylift

fitted with manufacturers secondary guarding as standard

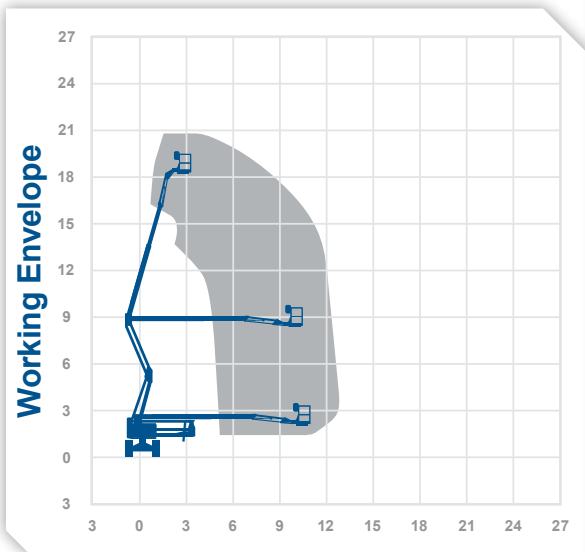

# HR21D

booms

**Working Height** 20.8m  
**Horizontal Outreach** 12.5m

Closed Length 5.3m  
Closed Height 2.15m  
Closed Width 2.27m  
Platform Size 1.8m x 0.85m  
Rotation 360°  
Max SWL 225kg  
Weight 6220kg

Alternative machines

HA20PX  
G60X

Manufacturer

Niftylift

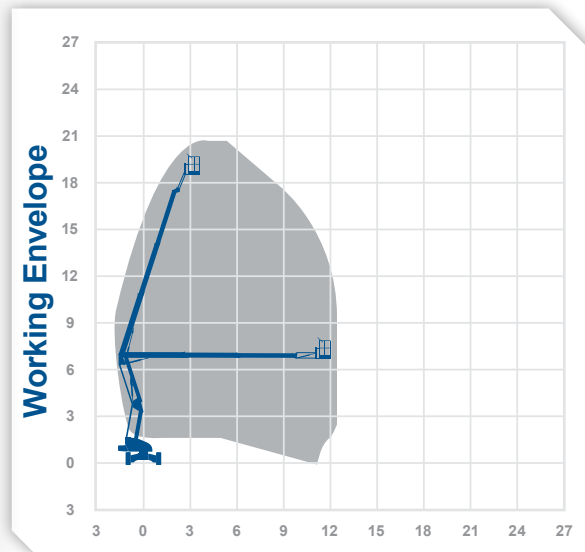

0345 745 0000  
nationwideplatforms.co.uk



**Nationwide Platforms**  
A Loxam Company

## Working Height 20.87m

## Horizontal Outreach 12.47m

Closed Length	9.25m
Closed Height	2.4m
Closed Width	2.49m
Platform Size	1.83m x 0.76m
Rotation	Continuous
Max SWL	227kg
Weight	10766kg

### Alternative machines

G60X  
60AJX

### Manufacturer

Genie

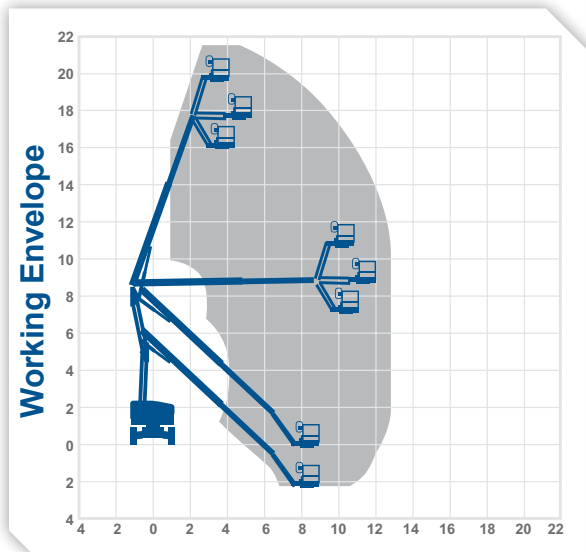

0345 745 0000  
nationwideplatforms.co.uk



## Working Height 21.8m

## Horizontal Outreach 17.1m

Closed Length	9.5m
Closed Height	2.72m
Closed Width	2.5m
Platform Size	1.83m x 0.76m
Rotation	Continuous
Max SWL	227kg
Weight	10102kg
Reach Below Ground	2.71m

### Alternative machines

G65X  
66JX

### Manufacturer

Genie

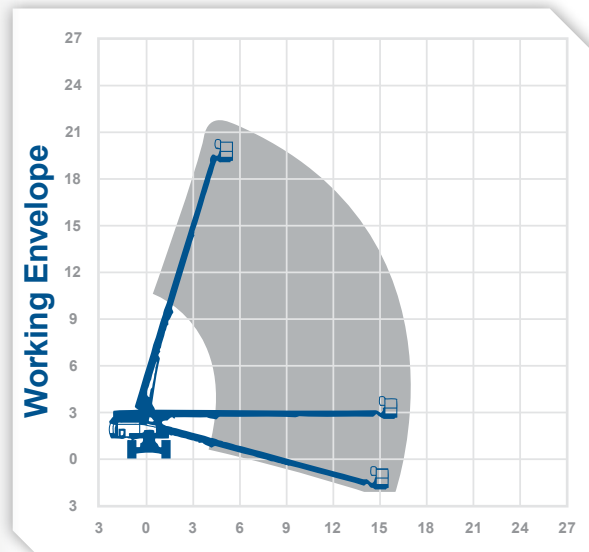

 **Nationwide Platforms**  
A **LOXAM** Company

## Working Height 22.12m

## Horizontal Outreach 17.3m

Closed Length	10.21m
Closed Height	2.56m
Closed Width	2.43m
Platform Size	1.83m x 0.91m
Rotation	180°
Max SWL	227kg
Weight	13500kg

### Alternative machines

S65X  
G65  
G65X

### Manufacturer

JLG

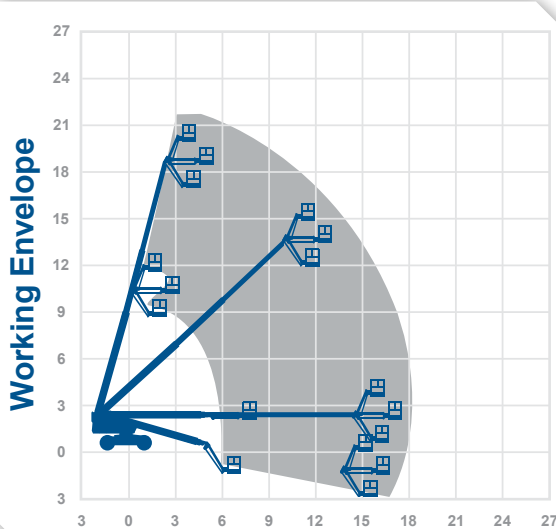

0345 745 0000  
nationwideplatforms.co.uk



## Working Height 22.5m

## Horizontal Outreach 18.3m

Closed Length	10.4m
Closed Height	2.7m
Closed Width	2.47m
Platform Size	2.44m x 0.91m
Rotation	Continuous
Max SWL	230kg
Weight	13400kg
Reach Below Ground	4.0m

### Alternative machines

S65X  
66JX

### Manufacturer

Haulotte

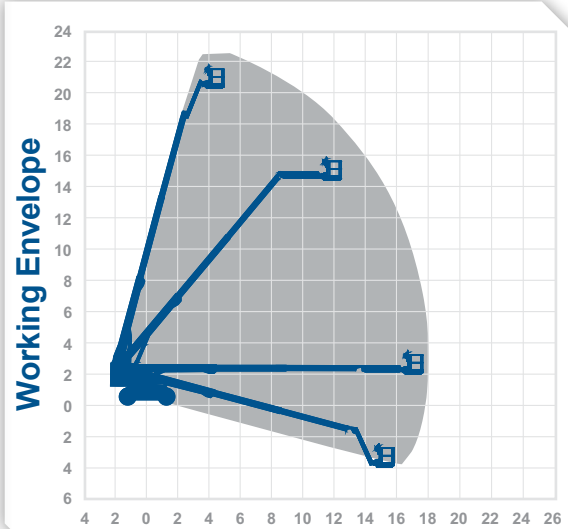

 Nationwide Platforms  
A Loxam Company

## Working Height 25.6m

## Horizontal Outreach 18.29m

Closed Length	11.27m
Closed Height	3.0m
Closed Width	2.49m
Platform Size	2.44m x 0.91m
Rotation	Continuous
Max SWL	227kg
Weight	17010kg

### Alternative machines

80JX

### Manufacturer

Genie

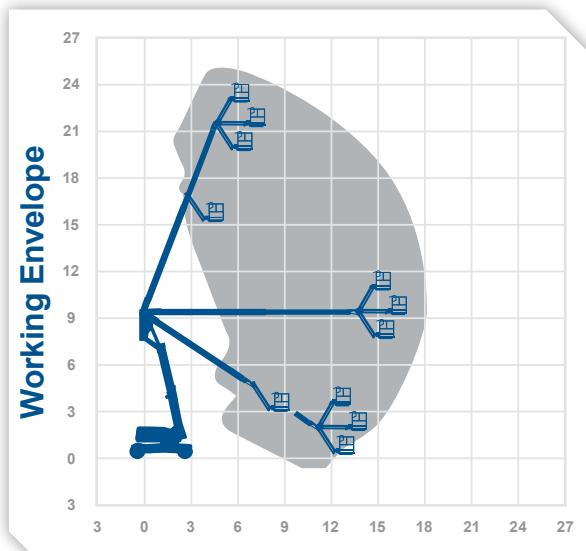

0345 745 0000  
nationwideplatforms.co.uk



## Working Height 25.6m

## Horizontal Outreach 16.2m

Closed Length	12.0m
Closed Height	2.71m
Closed Width	2.4m
Platform Size	1.8m x 0.8m
Rotation	360°
Max SWL	230kg
Weight	15890kg

### Alternative machines

80JX  
Z80

### Manufacturer

Haulotte

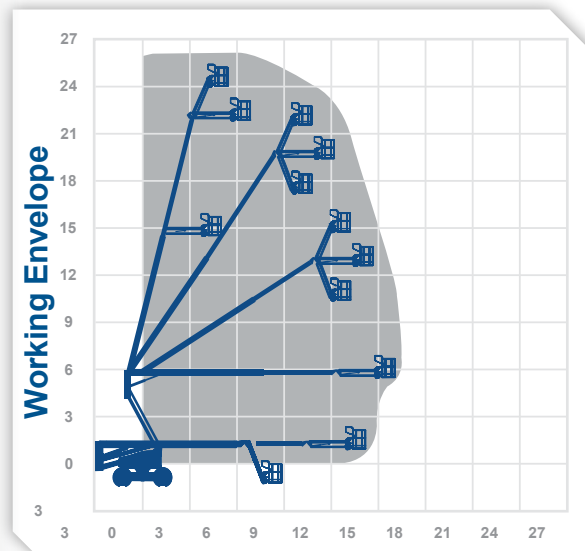

 Nationwide Platforms  
A Loxam Company



## Working Height 26.38m

## Horizontal Outreach 15.74m

Closed Length	11.12m
Closed Height	3.0m
Closed Width	2.44m
Platform Size	1.83m x 0.91m
Rotation	360°
Max SWL	230kg
Weight	15600kg

### Alternative machines

Z80

### Manufacturer

JLG

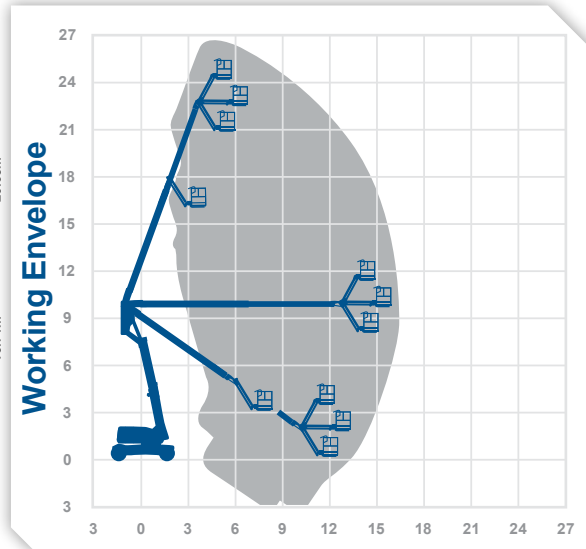

**0345 745 0000**  
[nationwideplatforms.co.uk](http://nationwideplatforms.co.uk)



**Nationwide Platforms**  
 A **LOXAM** Company

**Working Height** 27.7m  
**Horizontal Outreach** 23.4m

Closed Length	12.4m
Closed Height	2.8m
Closed Width	2.4m
Platform Size	1.8m x 0.76m
Rotation	Continuous
Max SWL	227kg
Weight	16500kg
Reach Below Ground	2.89m
Operational Full Width	3.07m

**Alternative machines**

G85  
860SJ

**Manufacturer**

Genie

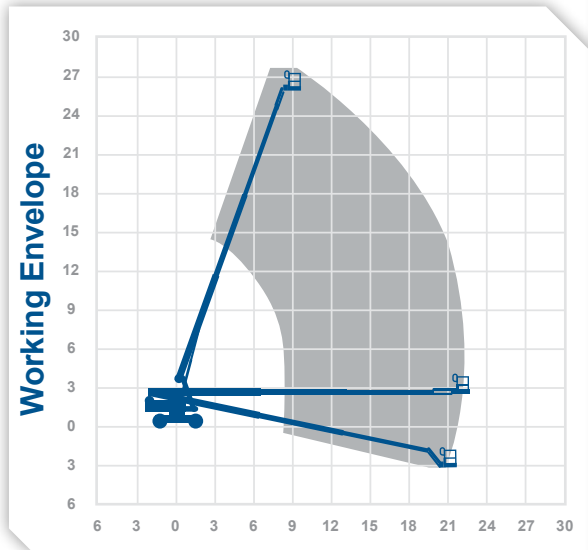

**Working Height** 27.9m  
**Horizontal Outreach** 23.32m

Closed Length	12.4m
Closed Height	2.8m
Closed Width	2.5m
Platform Size	1.83m x 0.76m
Rotation	Continuous
Max SWL	227kg
Weight	17236kg
Reach Below Ground	2.89m

**Alternative machines**

860SJ  
G85X

**Manufacturer**

Genie

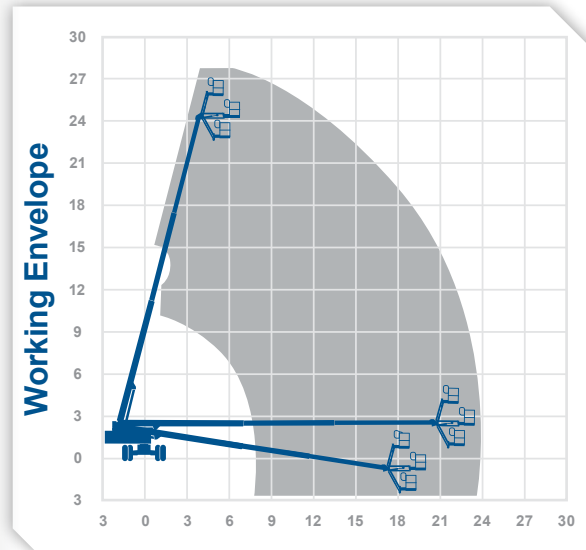

**0345 745 0000**  
[nationwideplatforms.co.uk](http://nationwideplatforms.co.uk)



**Nationwide Platforms**  
 A **LOXAM** Company

# HR28H

booms

**Working Height** 28.0m  
**Horizontal Outreach** 19.0m

Closed Length 9.28m  
Closed Height 2.7m  
Closed Width 2.49m  
Platform Size 2.4m x 0.9m  
Rotation 360°  
Max SWL 280kg  
Weight 14700kg

**Alternative machines**

Z80  
80J

**Manufacturer**

Niftylift

fitted with manufacturers secondary guarding as standard

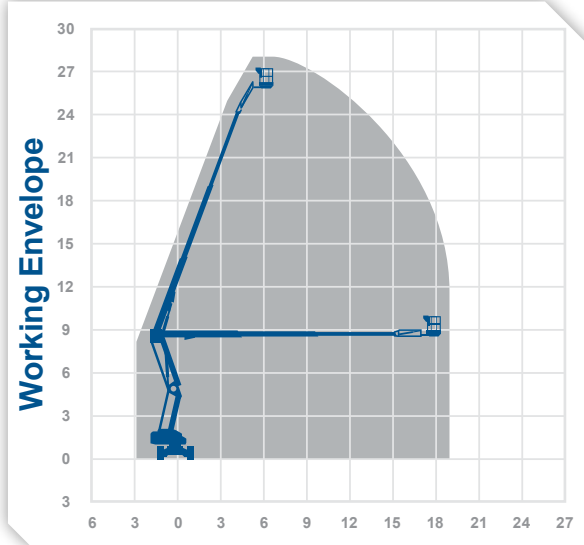

# 860SJ

booms

**Working Height** 28.21m  
**Horizontal Outreach** 22.86m

Closed Length 12.19m  
Closed Height 3.05m  
Closed Width 2.49m  
Platform Size 2.44m x 0.91m  
Rotation 360°  
Max SWL 227kg  
Weight 16511kg  
Reach Below Ground 3.0m

**Alternative machines**

G85X

**Manufacturer**

JLG

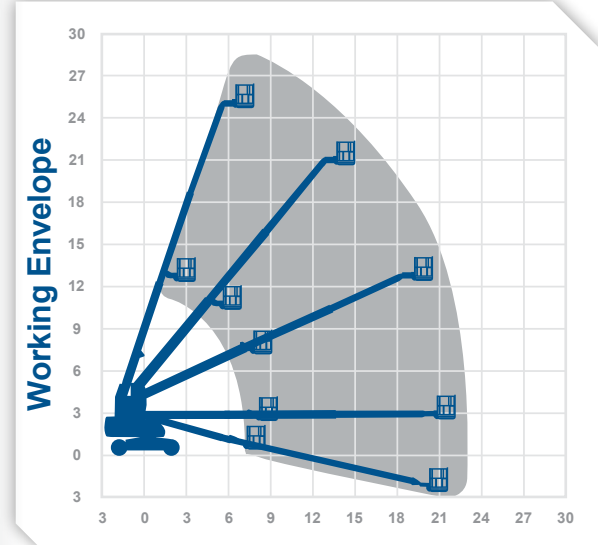

0345 745 0000  
nationwideplatforms.co.uk



**Nationwide Platforms**  
A **LOXAM** Company

**Working Height** 31.8m  
**Horizontal Outreach** 21.3m

Closed Length 11.16m  
 Closed Height 2.7m  
 Closed Width 2.5m  
 Platform Size (extended) 2.44(3.33)m 0.80m  
 Continuous  
 Rotation 250kg  
 Max SWL 20800kg  
 Weight 4.0m  
 Reach Below Ground

Alternative machines

1250AJP

Manufacturer

Haulotte

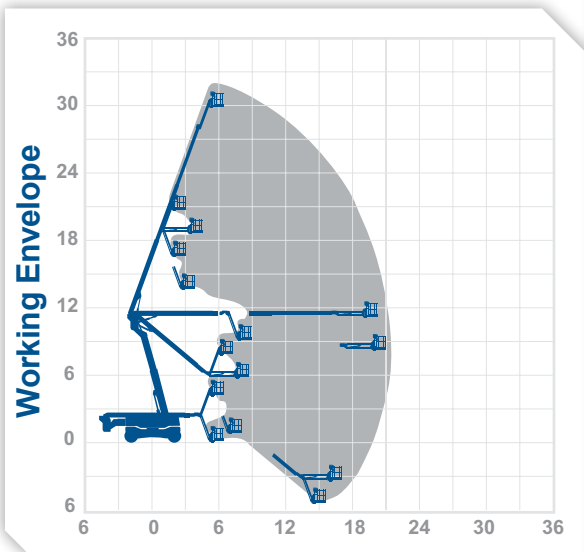

**0345 745 0000**  
[nationwideplatforms.co.uk](http://nationwideplatforms.co.uk)

**Working Height** 38.73m  
**Horizontal Outreach** 22.86m

Closed Length 10.64m  
 Closed Height 3.05m  
 Closed Width 2.49m  
 Platform Size 2.44m x 0.91m  
 Rotation Continuous  
 Max SWL 230kg  
 Weight 18500kg  
 Operational Full Width 3.81m

Alternative machines

S125

Manufacturer

JLG

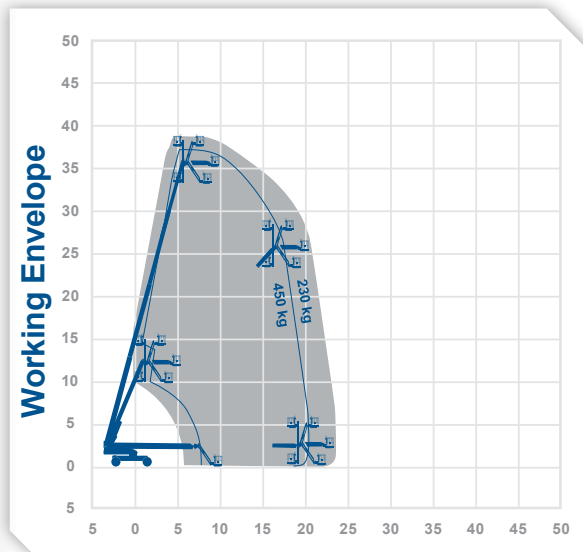

**Nationwide Platforms**  
 A **LOXAM** Company



**Working Height** 40.1m  
**Horizontal Outreach** 19.25m

Closed Length	11.45m
Closed Height	3.05m
Closed Width	2.49m
Platform Size	2.44m x 0.91m
Rotation	Continuous
Max SWL	227kg
Weight	19958kg
Operational Full Width	3.81m

**Alternative machines**

1350SJP  
Z135

**Manufacturer**

JLG

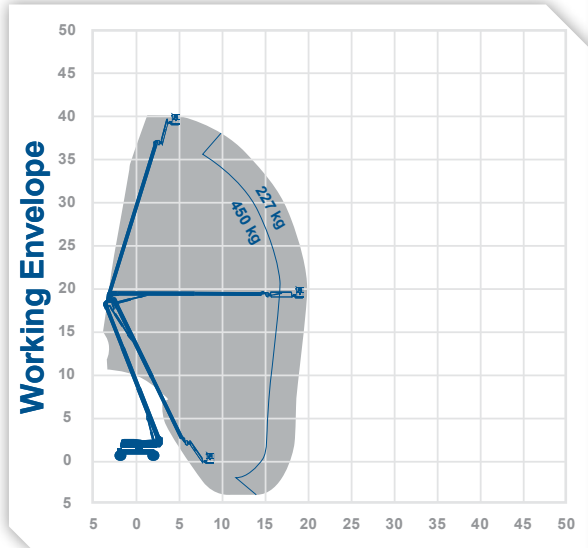

**0345 745 0000**  
[nationwideplatforms.co.uk](http://nationwideplatforms.co.uk)



**Working Height** 40.15m  
**Horizontal Outreach** 24.38m

Closed Length	14.25m
Closed Height	3.07m
Closed Width	2.49m
Platform Size	2.44m x 0.91m
Rotation	Continuous
Max SWL	227kg
Weight	20248kg
Operational Full Width	3.35m

**Alternative machines**

1200SJP  
1350SJP

**Manufacturer**

Genie

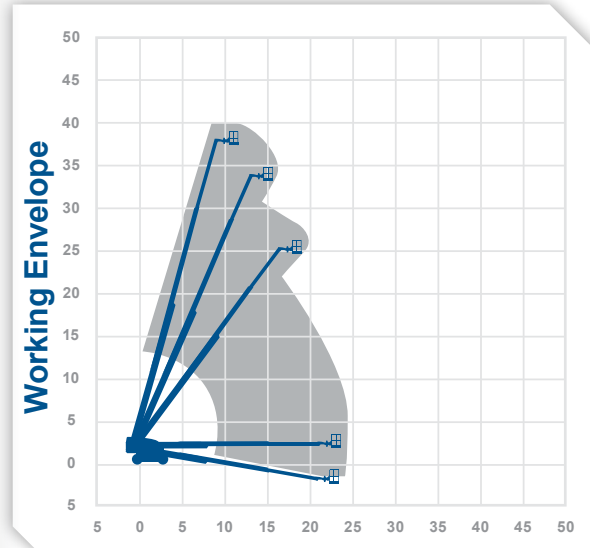

**Nationwide Platforms**  
 A **LOXAM** Company

**Working Height 41.5m**

**Horizontal Outreach 20.1m**

Closed Length	13.1m
Closed Height	3.0m
Closed Width	2.53m
Platform Size	2.44m x 0.91m
Rotation	360°
Max SWL	230kg
Weight	23900kg
Reach Below Ground	1.5m
Operational Full Width	3.3m

**Alternative machines**

Z135  
1250AJP

**Manufacturer**

Haulotte

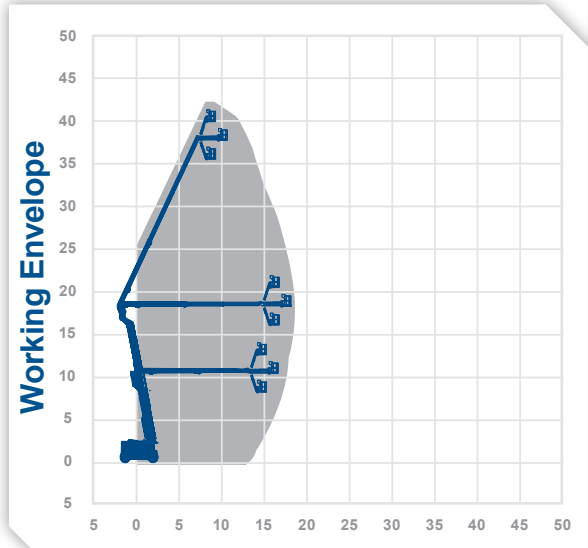

**0345 745 0000**  
[nationwideplatforms.co.uk](http://nationwideplatforms.co.uk)



**Working Height 43.15m**

**Horizontal Outreach 21.26m**

Closed Length	12.93m
Closed Height	3.07m
Closed Width	2.46m
Platform Size	2.44m x 0.91m
Rotation	Continuous
Max SWL	272kg
Weight	20366kg
Reach Below Ground	5.87m
Operational Full Width	3.94m

**Alternative machines**

1350SJP  
1250AJP  
ZX135  
150HAX

**Manufacturer**

Genie

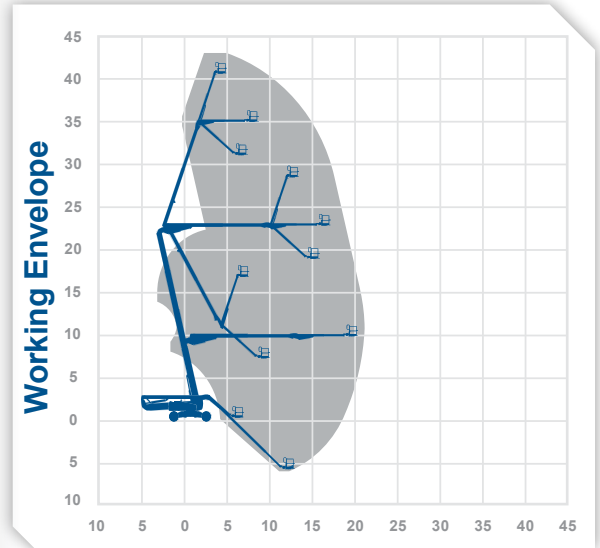

**Nationwide Platforms**  
A **LOXAM** Company

**Working Height 43.15m**  
**Horizontal Outreach 21.26m**

Closed Length	12.93m
Closed Height	3.09m
Closed Width	2.49m
Platform Size	2.44m x 0.91m
Rotation	Continuous
Max SWL	272kg
Weight	20502kg
Reach Below Ground	5.87m
Operational Full Width	5.03m

**Alternative machines**

Z135  
 1350SJP  
 1250AJP  
 150HAX

**Manufacturer**

Genie

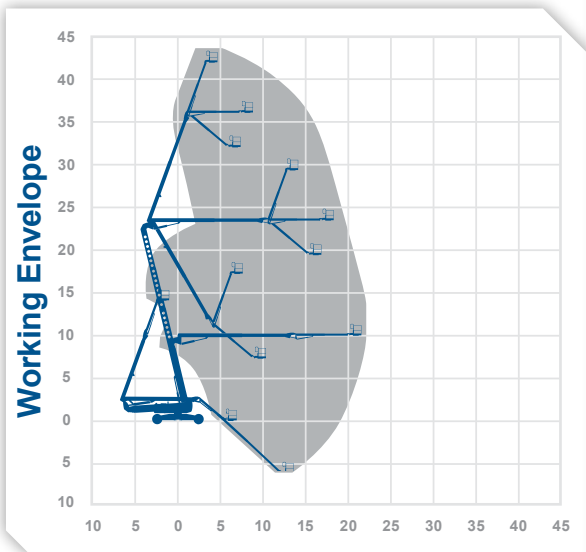

**Working Height 43.15m**  
**Horizontal Outreach 27.43m**

Closed Length	19.76m
Closed Height	3.05m
Closed Width	2.49m
Platform Size	2.44m x 0.91m
Rotation	Continuous
Max SWL	454kg
Weight	21747kg
Reach Below Ground	6.0m
Operational Full Width	3.94m

**Alternative machines**  
 1350SJP

**Manufacturer**

Genie

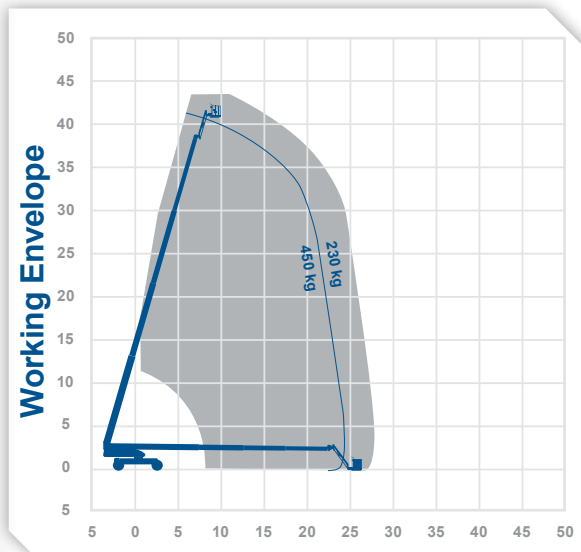

**0345 745 0000**  
**nationwideplatforms.co.uk**



**Nationwide Platforms**  
 A **LOXAM** Company

**Working Height** 43.3m  
**Horizontal Outreach** 24.38m

Closed Length 11.86m  
 Closed Height 3.05m  
 Closed Width 2.49m  
 Platform Size 2.44m x 0.91m  
 Rotation Continuous  
 Max SWL 230kg  
 Weight 20400kg  
 Operational Full Width 3.81m

**Alternative machines**

Z135  
 1200SJP  
 S125

**Manufacturer**

JLG

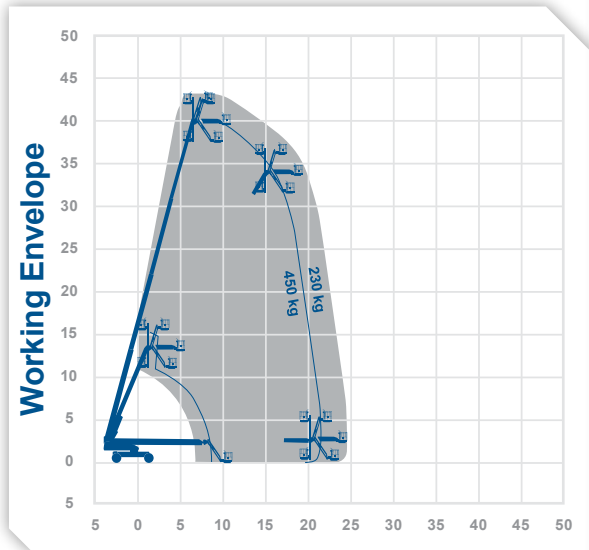

**0345 745 0000**  
[nationwideplatforms.co.uk](http://nationwideplatforms.co.uk)

**Working Height** 48.02m  
**Horizontal Outreach** 24.38m

Closed Length 16.18m  
 Closed Height 3.05m  
 Closed Width 2.49m  
 Platform Size 2.44m x 0.91m  
 Rotation Continuous  
 Max SWL 340kg  
 Weight 23236kg  
 Reach Below Ground 0.91m  
 Operational Full Width 5.03m

**Alternative machines**

SX180

**Manufacturer**

Genie

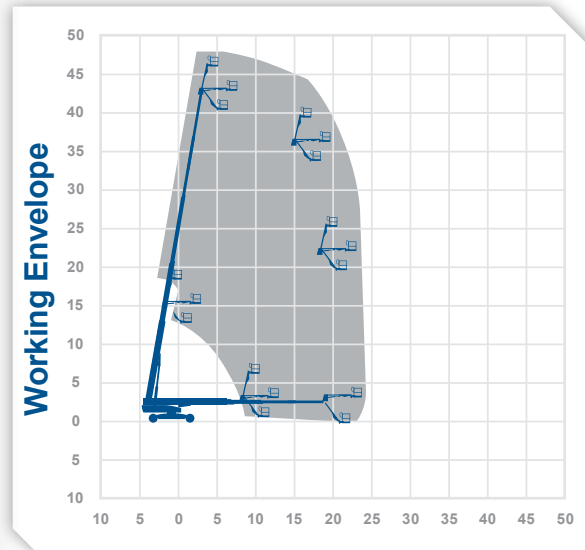

**Nationwide Platforms**  
 A **LOXAM** Company





### Working Height **48.15m** Horizontal Outreach **23.55m**

Closed Length	15.1m
Closed Height	3.1m
Closed Width	2.5m
Platform Size (extended)	2.44(5)m x 0.91m
Rotation	Continuous
Max SWL (extended)	450(270)kg
Weight	26127kg
Reach Below Ground	6.1m
Operational Full Width	5m

Manufacturer  
JLG

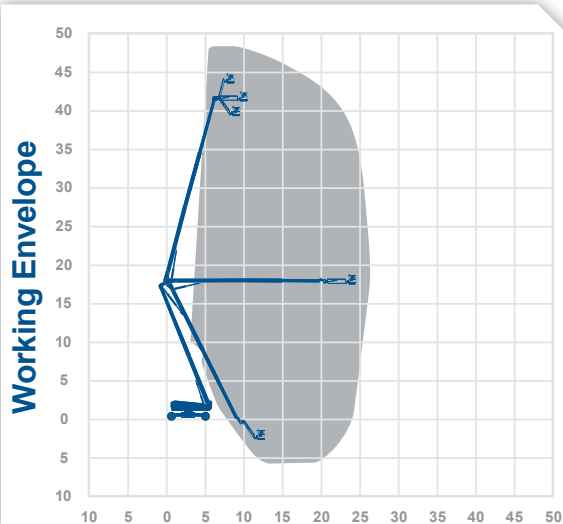

**0345 745 0000**  
[nationwideplatforms.co.uk](http://nationwideplatforms.co.uk)

### Working Height **56.86m** Horizontal Outreach **24.38m**

Closed Length	14.33m
Closed Height	3.05m
Closed Width	2.49m
Platform Size	2.44m x 0.91m
Rotation	Continuous
Max SWL	340kg
Weight	25095kg
Operational Full Width	5.03m

Manufacturer  
Genie

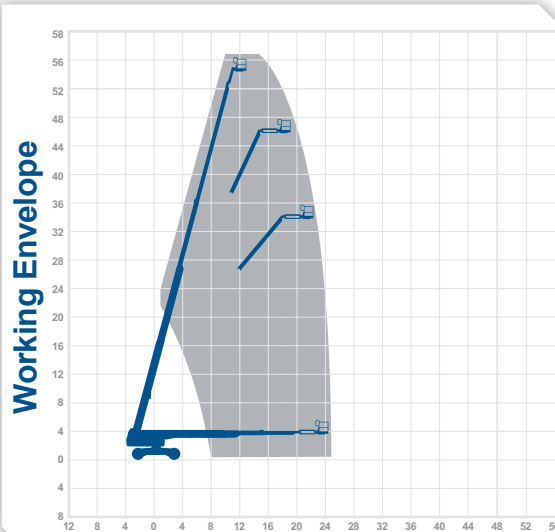

**Nationwide Platforms**  
A **LOXAM** Company



# Van Mounted



- More than 290 units available to hire across the UK
- Versalift boom assemblies on most models
- All vehicles comply to EN280:2001 and are CE certified
- Dual roof mounted beacons/working lights
- Reverse alarms and night switches
- Steel bulkheads
- Internal racking, ply lining and hot and cold hand wash unit option available
- Tracker devices available as options on long term hires
- Operated or self-drive options available

## Machine type by product code

VT125K

V14E

VT12E

V16E



0345 745 0000  
nationwideplatforms.co.uk



**Nationwide Platforms**  
A **LOXAM** Company

# VT125K

van  
mounts

## Working Height 12.0m Horizontal Outreach 7.0m

Max Horiz. Outreach (full SWL)	7.0m
Overall travel Length	6.8m
Overall travel Height	3.3m
Overall travel Width	2.2m
Platform/cage size	1.0m x 0.60m
Max SWL	200kg
Gross vehicle weight class	3500kg
Operational Full Width	2.45m
Minimum Operational width (straight down jacking)	As above

### Alternative machines

V12E  
VI125K

### Manufacturer

GSR

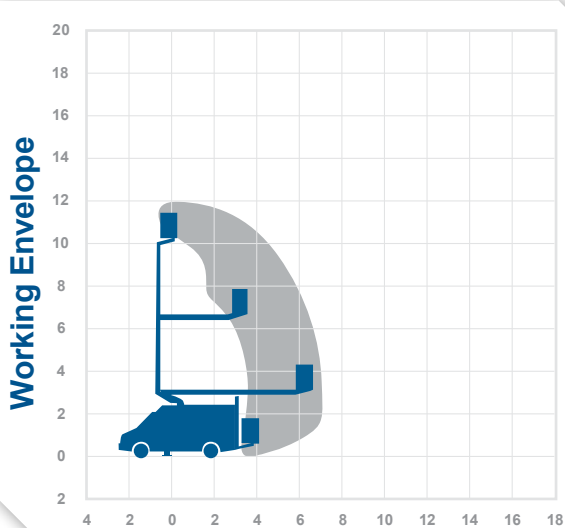

0345 745 0000  
nationwideplatforms.co.uk



# VT12E

van  
mounts

## Working Height 13.0m Horizontal Outreach 7.0m

Max Horiz. Outreach (full SWL)	7.0m
Overall travel Length	6.74m
Overall travel Height	3.15m
Overall travel Width	2.2m
Platform/cage size	1.0m x 0.60m
Max SWL	200kg
Gross vehicle weight class	3500kg
Operational Full Width	2.45m
Minimum Operational width (straight down jacking)	As above

### Alternative machines

V14E

### Manufacturer

Versalift

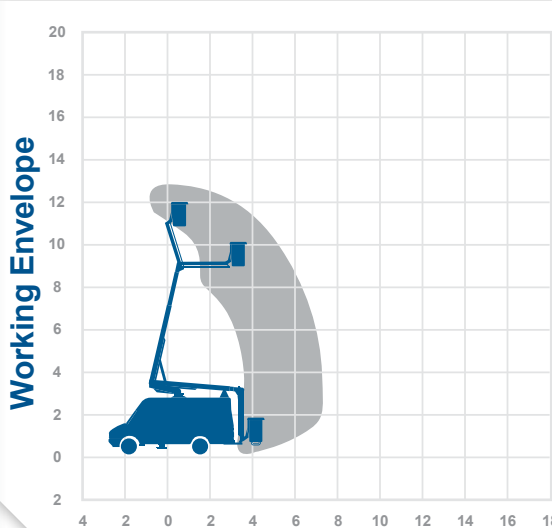

Nationwide Platforms  
A Loxam Company

# V14E

van  
mounts

## Working Height 14.2m Horizontal Outreach 7.3m

Max Horiz. Outreach (full SWL)	7.3m
Overall travel Length	7.34m
Overall travel Height	3.8m
Overall travel Width	2.2m
Platform/cage size	1.0m x 0.6m
Max SWL	200kg
Gross vehicle weight class	5200kg
Operational Full Width	2.25m
Minimum Operational width (straight down jacking)	As above

### Alternative machines

V16E

### Manufacturer

Versalift

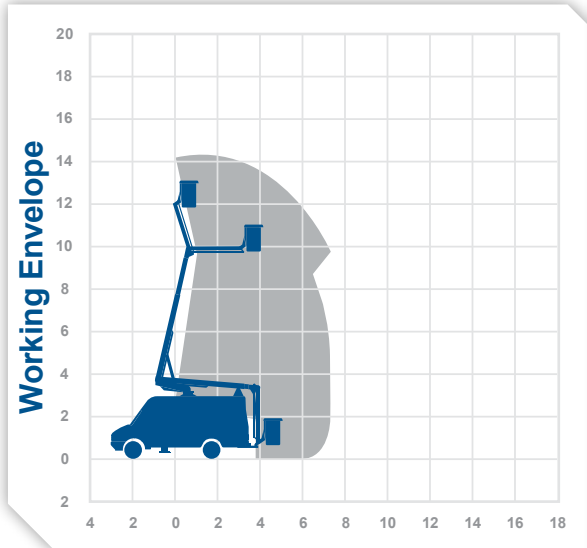

0345 745 0000  
nationwideplatforms.co.uk

# V16E

van  
mounts

## Working Height 16.5m Horizontal Outreach 7.3m

Max Horiz. Outreach (full SWL)	7.3m
Overall travel Length	8.22m
Overall travel Height	4.0m
Overall travel Width	2.2m
Platform/cage size	1.0m x 0.6m
Max SWL	200kg
Gross vehicle weight class	6500kg
Operational Full Width	2.45m
Minimum Operational width (straight down jacking)	As above

### Alternative machines

T16N  
T17GS

### Manufacturer

Versalift

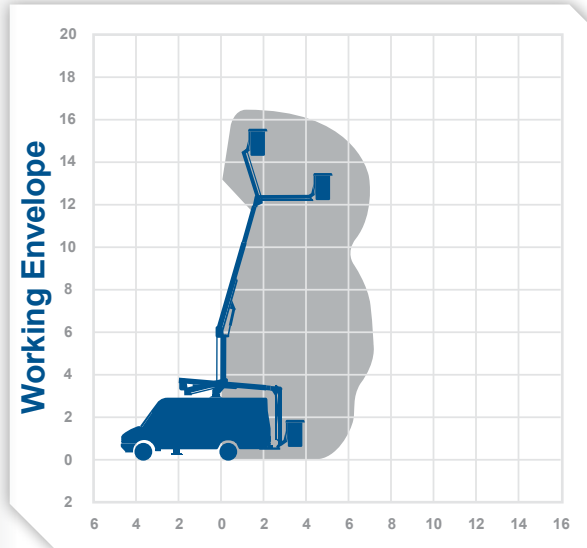

Nationwide Platforms  
A Loxam Company



# Truck Mounted



- More than 300 units available to hire across the UK
- Working heights from 13m to 90m
- Self drive options up to 26m (3.5T and 7.5T chassis)
- All vehicles available with experienced IPAF trained operators
- Most cost effective method of access for short term hires
- Large fleet of 4 wheel drive machines – ideal for off road application
- Narrow jacking and zero tail swing models available
- Models with SWL of up to 700kg

## Machine type by product code

T1135EX	T22AS	T38B
T14GS	T22GS	T44B
T17BE	T22GSH	T46B
T17GS	T26CX	T48P
T18AS	T26GS	T50JB
T18ASH	T27R	T56B-XR
T20HC	T28RX	T58R
T20GS	T33R	T70B
T20M	T33RH	T70B-XR
T21JC	T37R	T90B

**0345 745 0000**  
**nationwideplatforms.co.uk**



**Nationwide Platforms**  
A **LOXAM** Company

# T1135EX

truck  
mounts

## Working Height 13.3m Outreach 6.1m

Max Reach Below 0m	n/a
Overall Travel Length	4.7m
Overall Travel Height	2.6m
Overall Travel Width	2.0m
Platform Cage Size	1.0m X 0.6m
Max SWL	230kg
Gross Vehicle Weight	3500kg
Operational Full Width	2.4m
Minimum Operational Width	2.4m
Point Load Front / Rear	20kN / 20kN

Manufacturer  
Versalift

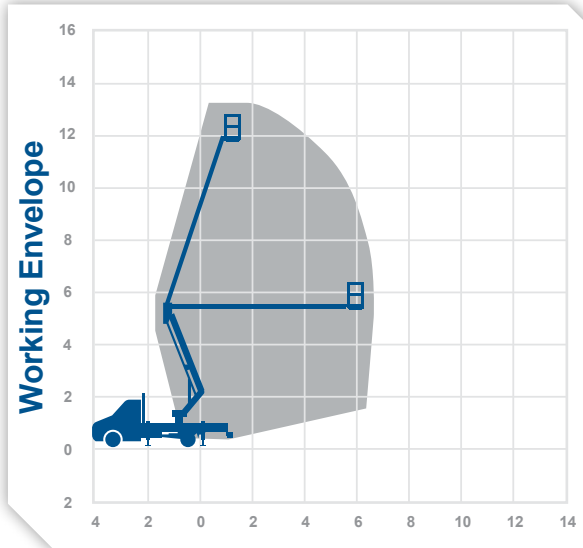

0345 745 0000  
nationwideplatforms.co.uk

# T14GS

truck  
mounts

## Working Height 14.0m Outreach 8.0m

Overall Travel Length	7.2m
Overall Travel Height	2.95m
Overall Travel Width	2.1m
Platform Cage Size	1.4m x 0.7m
Max SWL	200kg
Gross Vehicle Weight	3500kg
Operational Full Width	2.4m
Minimum Operational Width	2.4m
Point Load Front / Rear	28kN / 28kN

Manufacturer  
GSR

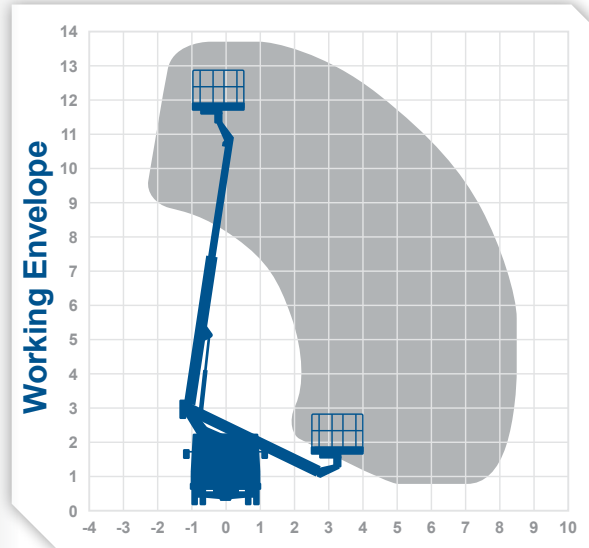

Nationwide Platforms  
A Loxam Company



# T17BE

truck  
mounts

**Working Height** 17.2m  
**Outreach** 10.0m

Max Horiz. Outreach (full SWL)	8.0m
Overall Travel Length	7.2m
Overall Travel Height	3.7m
Overall Travel Width	2.5m
Platform Cage Size	1.0m x 0.6m
Max SWL	265kg
Gross Vehicle Weight	6500kg
Operational Full Width	2.4m
Minimum Operational Width	2.4m
Point Load Front / Rear	60kN / 60kN

Alternative machines

T18AS

Manufacturer

Versalift

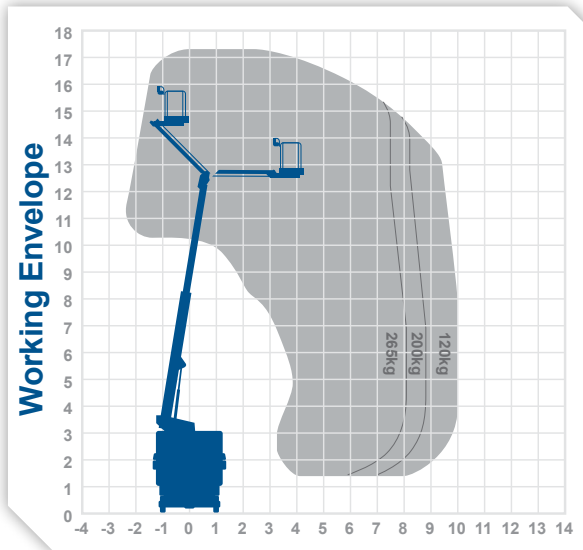

# T17GS

truck  
mounts

**Working Height** 17.1m  
**Outreach** 9.5m

Max Horiz. Outreach (full SWL)	6.7m
Overall Travel Length	7.1m
Overall Travel Height	2.95m
Overall Travel Width	2.2m
Platform Cage Size	1.4m x 0.7m
Max SWL	250kg
Gross Vehicle Weight	3500kg
Operational Full Width	2.4m
Minimum Operational Width	2.4m
Point Load Front / Rear	28kN / 28kN

Alternative machines

T18AS

Manufacturer

GSR

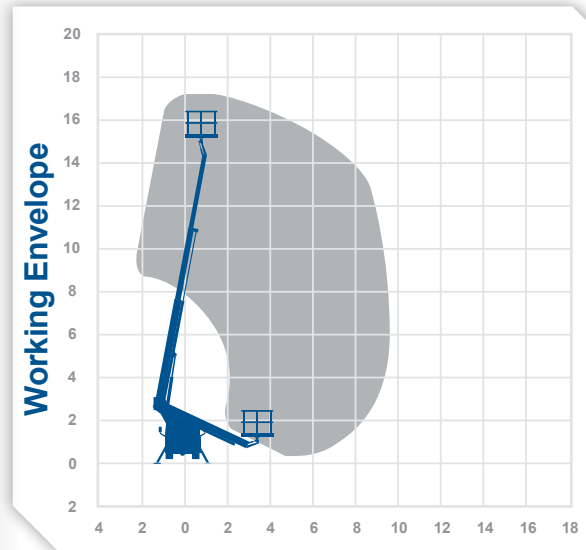

0345 745 0000  
nationwideplatforms.co.uk



**Nationwide Platforms**  
A **LOXAM** Company

# T18AS

truck  
mounts

**Working Height** 18.0m  
**Outreach** 13.0m

Overall Travel Length	7.0m
Overall Travel Height	3.0m
Overall Travel Width	2.3m
Platform Cage Size	1.4m x 0.73m
Max SWL	230kg
Gross Vehicle Weight	3500kg
Operational Full Width	3.6m
Minimum Operational Width	2.3m
Point Load Front / Rear	28kN / 28kN

**Alternative machines**

T18ASH  
T20M  
T20HC  
T20GS

**Manufacturer**

Ascendant

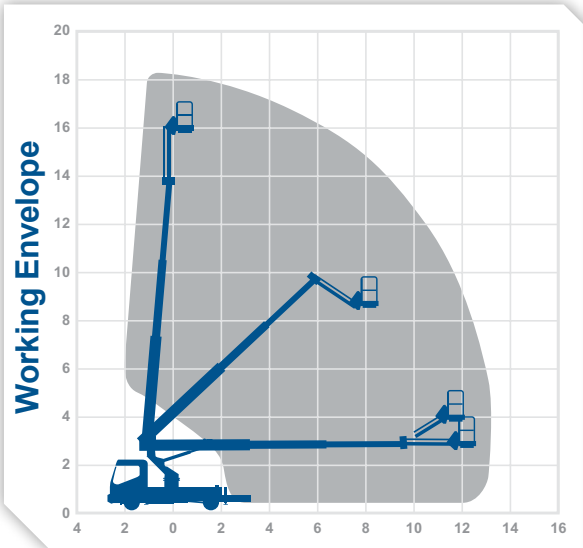

0345 745 0000  
nationwideplatforms.co.uk

# T18ASH

truck  
mounts

**Working Height** 18.0m  
**Outreach** 13.0m

Max Horiz. Outreach (full SWL)	13.0m
Overall Travel Length	7.0m
Overall Travel Height	3.0m
Overall Travel Width	2.1m
Platform Cage Size	1.4m x 0.73m
Max SWL	230kg
Gross Vehicle Weight	5000kg
Operational Full Width	3.8m
Minimum Operational Width	2.3m
Point Load Front / Rear	50kN / 50kN

**Alternative machines**

T18AS

**Manufacturer**

Ascendant

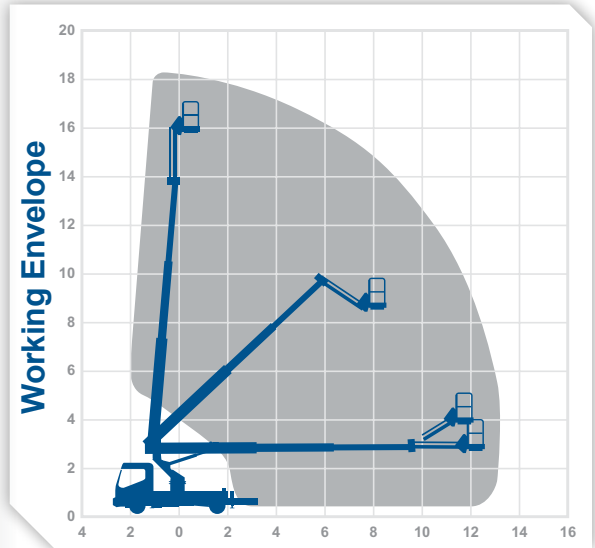

**Nationwide Platforms**  
A **LOXAM** Company





# T20HC



**Working Height** 20.0m  
**Outreach** 9.0m

Overall Travel Length	6.76m
Overall Travel Height	2.5m
Overall Travel Width	2.1m
Platform Cage Size	1.4m x 0.7m
Max SWL	300kg
Gross Vehicle Weight	3500kg
Operational Full Width	2.93m
Minimum Operational Width	2.93m
Point Load Front / Rear	28kN / 28kN

Alternative machines  
T20M  
  
Manufacturer  
CTE

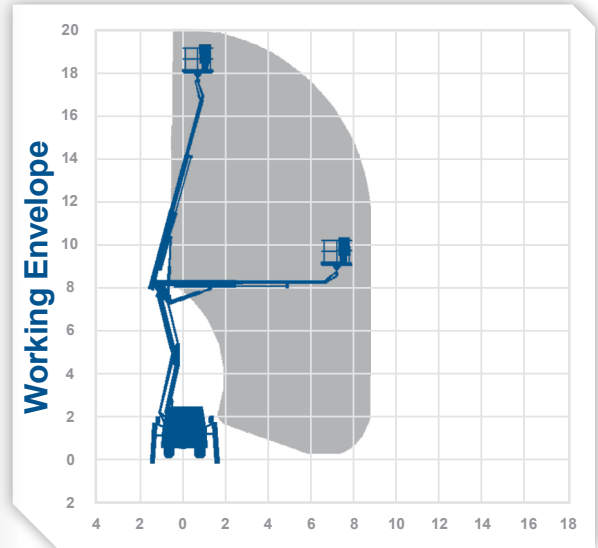

0345 745 0000  
nationwideplatforms.co.uk



**Nationwide Platforms**  
A **LOXAM** Company

# T20GS

truck  
mounts

## Working Height 20.0m Outreach 8.2m

Overall Travel Length	7.46m
Overall Travel Height	2.77m
Overall Travel Width	2.1m
Platform Cage Size	1.4m x 0.7m
Max SWL	280kg
Gross Vehicle Weight	3500kg
Operational Full Width	2.3m
Minimum Operational Width	2.3m
Point Load Front / Rear	25kN / 18kN

Alternative machines

Manufacturer

GSR

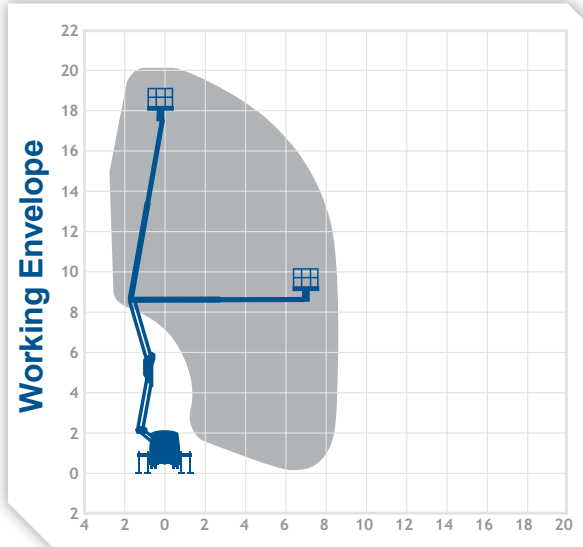

0345 745 0000  
nationwideplatforms.co.uk



# T20M

truck  
mounts

## Working Height 20.0m Outreach 11.0m (80kg)

Max Horiz. Outreach (full SWL)	8.6m
Max Reach Below 0m	2.0m
Overall Travel Length	7.65m
Overall Travel Height	3.0m
Overall Travel Width	2.1m
Platform Cage Size	1.4m x 0.7m
Max SWL	250kg
Gross Vehicle Weight	3500kg
Operational Full Width	3.4m
Minimum Operational Width	2.5m
Point Load Front / Rear	30kN / 19kN

Alternative machines

T20C

T21JC

Manufacturer

Multitel

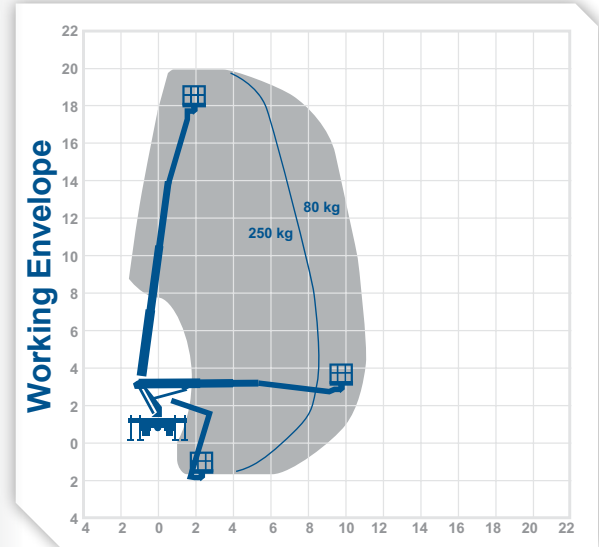

Nationwide Platforms  
A Loxam Company

# T21JC

truck  
mounts

## Working Height 21.0m Outreach 10.0m

Max Reach Below 0m	n/a
Overall Travel Length	6.8m
Overall Travel Height	2.6m
Overall Travel Width	2.1m
Platform Cage Size	1.4m x 0.7m
Max SWL	280kg
Gross Vehicle Weight	3500kg
Operational Full Width	2.9m
Minimum Operational Width	2.9m
Point Load Front / Rear	28kN / 28kN

### Alternative machines

T20C  
T20M

### Manufacturer

CTE

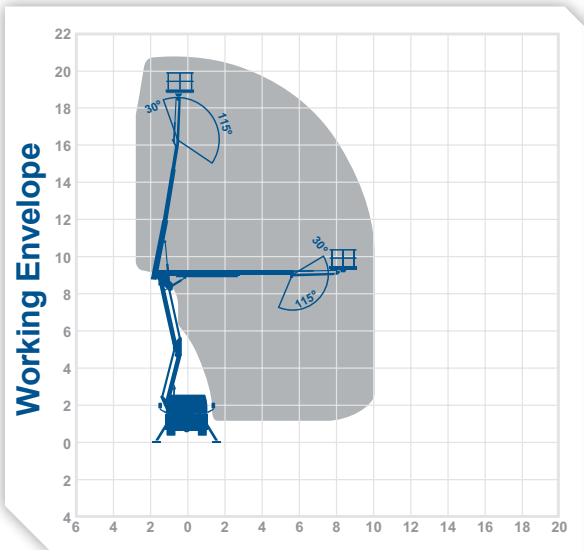

# T22AS

truck  
mounts

## Working Height 22.0m Outreach 17.5m

Max Reach Below 0m	n/a
Overall Travel Length	9.2m
Overall Travel Height	3.5m
Overall Travel Width	2.4m
Platform Cage Size	1.8m x 1.1m
Max SWL*	280kg
Gross Vehicle Weight	7500kg
Operational Full Width	4.5m
Minimum Operational Width	2.5m
Point Load Front / Rear	60kN / 60kN

### Alternative machines

T22GS

### Manufacturer

Ascendant

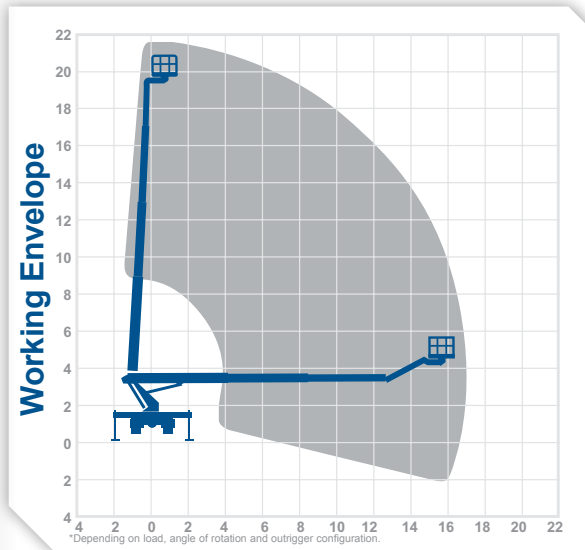

0345 745 0000  
nationwideplatforms.co.uk



**Nationwide Platforms**  
A **LOXAM** Company

# T22GS

truck  
mounts

**Working Height** 22.0m  
**Outreach** 17.7m

Max Reach Below 0m	n/a
Overall Travel Length	8.7m
Overall Travel Height	3.55m
Overall Travel Width	2.5m
Platform Cage Size	1.8m x 0.8m
Max SWL*	280kg
Gross Vehicle Weight	7500kg
Operational Full Width	4.5m
Minimum Operational Width	2.5m
Point Load Front / Rear	60kN / 60kN

Alternative machines

T22AS

Manufacturer

GSR

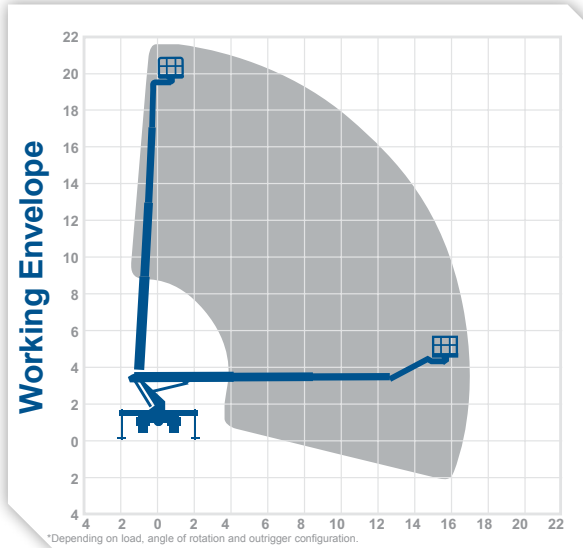

# T22GSH

truck  
mounts

**Working Height** 22.0m  
**Outreach** 17.7m

Max Reach Below 0m	n/a
Overall Travel Length	8.7m
Overall Travel Height	3.55m
Overall Travel Width	2.5m
Platform Cage Size	1.8m x 0.8m
Max SWL	280kg
Gross Vehicle Weight	8200kg
Operational Full Width	4.5m
Minimum Operational Width	2.5m
Point Load Front / Rear	60kN / 60kN

Alternative machines

T22GS

Manufacturer

GSR

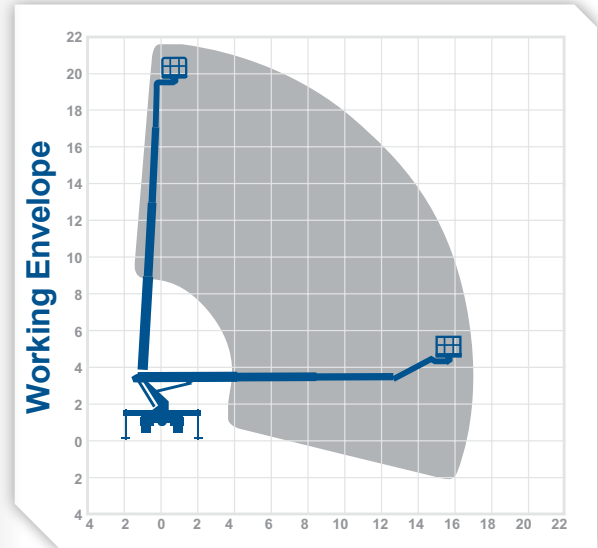

0345 745 0000  
nationwideplatforms.co.uk



**Nationwide Platforms**  
A Loxam Company

# T26CX

truck  
mounts

## Working Height 26.0m Outreach 12.5m

Overall Travel Length	7.45m
Overall Travel Height	3.9m
Overall Travel Width	2.6m
Platform Cage Size	1.4m x 0.7m
Max SWL	230kg
Gross Vehicle Weight	14000kg
Operational Full Width	3.12m
Minimum Operational Width	3.12m
Point Load Front / Rear	140kN / 140kN

### Alternative machines

T26WX  
T26KX

### Manufacturer

CTE

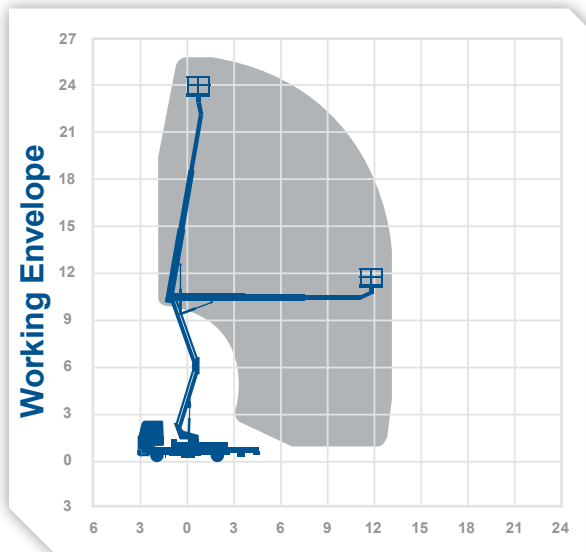

# T26GS

truck  
mounts

## Working Height 26.0m Outreach 14.0m (280kg)

Max Horiz. Outreach (full SWL)	14.0m
Overall Travel Length	7.8m
Overall Travel Height	3.6m
Overall Travel Width	2.5m
Platform Cage Size	1.4m x 0.7m
Max SWL	280kg
Gross Vehicle Weight	7500kg
Operational Full Width	3.5m
Minimum Operational Width	3.5m
Point Load Front / Rear	60kN / 60kN

### Alternative machines

T26C

### Manufacturer

GSR

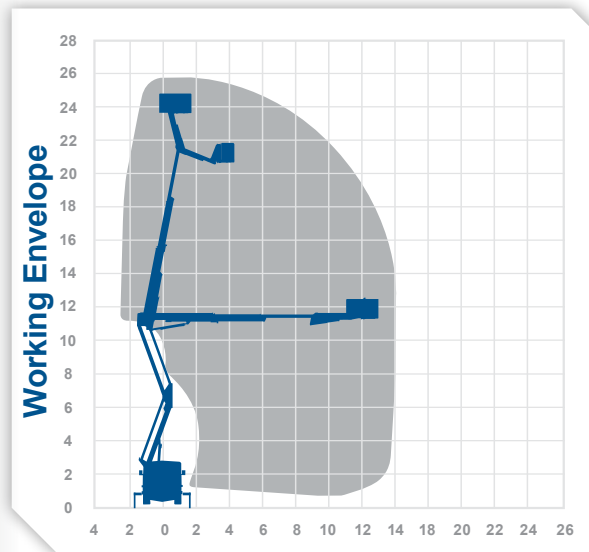

0345 745 0000  
nationwideplatforms.co.uk



**Nationwide Platforms**  
A **LOXAM** Company

# T27R

truck  
mounts

**Working Height** 27.0m  
**Outreach\*\*** 21.0m (100kg)

Max Horiz. Outreach (full SWL) 16.0m  
Max Reach Below 0m n/a  
Overall Travel Length 7.87m  
Overall Travel Height 3.3m  
Overall Travel Width 2.54m  
Platform Cage Size 1.85m x 1.0m  
Max SWL 320kg  
Gross Vehicle Weight 7500kg  
Operational Full Width 5.1m  
Minimum Operational Width 2.5m  
Point Load Front / Rear 72kN / 55kN

Alternative machines

T26C

**Manufacturer**  
Ruthman

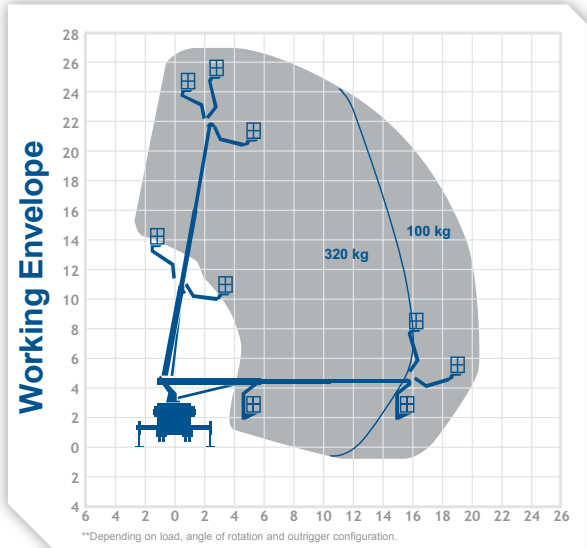

\*\*Depending on load, angle of rotation and outrigger configuration.

# T28RX

truck  
mounts

**Working Height** 28.0m  
**Outreach\*\*** 21.3m (100kg)

Max Horiz. Outreach (full SWL) 16.0m  
Max Reach Below 0m n/a  
Overall Travel Length 8.12m  
Overall Travel Height 3.8m  
Overall Travel Width 2.5m  
Platform Cage Size 1.7m x 0.86m  
Max SWL 320kg  
Gross Vehicle Weight 11000kg  
Operational Full Width 3.8m  
Minimum Operational Width 2.5m  
Point Load Front / Rear 110kN / 50kN

Alternative machines

T26CX

**Manufacturer**  
Ruthman

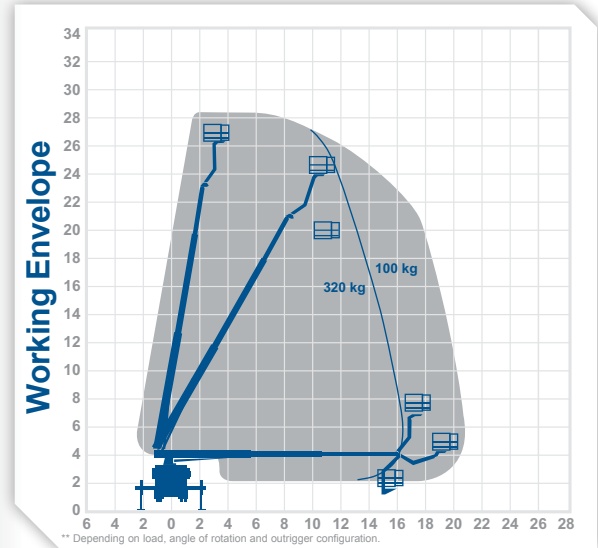

\*\*Depending on load, angle of rotation and outrigger configuration.

0345 745 0000  
nationwideplatforms.co.uk



**Nationwide Platforms**  
A **LOXAM** Company

# T33R

truck  
mounts

**Working Height** 33.0m  
**Outreach\*\*** 21.2m (100kg)

Max Horiz. Outreach (full SWL)	16.5m
Overall Travel Length	8.7m
Overall Travel Height	3.56m
Overall Travel Width	2.5m
Platform Cage Size	1.7m x 0.86m
Max SWL	320kg
Gross Vehicle Weight	7490kg
Operational Full Width	5.32m
Minimum Operational Width	2.53m
Point Load Front / Rear	56kN / 42kN

Alternative machines

T33RH

**Manufacturer**

Ruthman

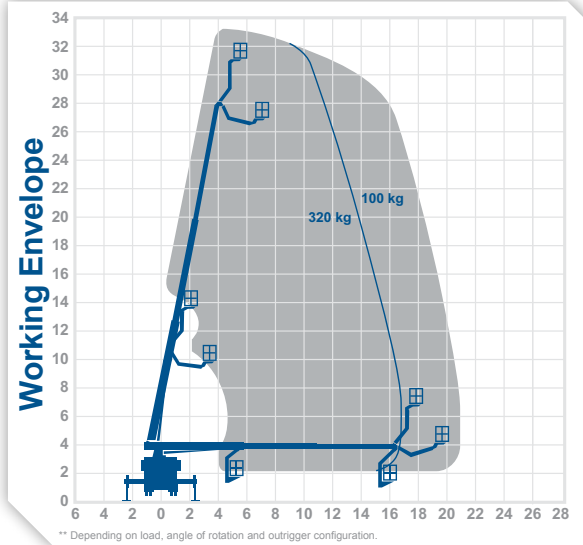

# T33RH

truck  
mounts

**Working Height** 33.0m  
**Outreach\*\*** 21.2m (100kg)

Max Horiz. Outreach (full SWL)	16.5m
Max Reach Below 0m	n/a
Overall Travel Length	8.7m
Overall Travel Height	3.56m
Overall Travel Width	2.5m
Platform Cage Size	1.7m x 0.86m
Max SWL	320kg
Gross Vehicle Weight	8600kg
Operational Full Width	5.32m
Minimum Operational Width	2.53m
Point Load Front / Rear	56kN / 42kN

Alternative machines

T37R

T38B

**Manufacturer**

Ruthman

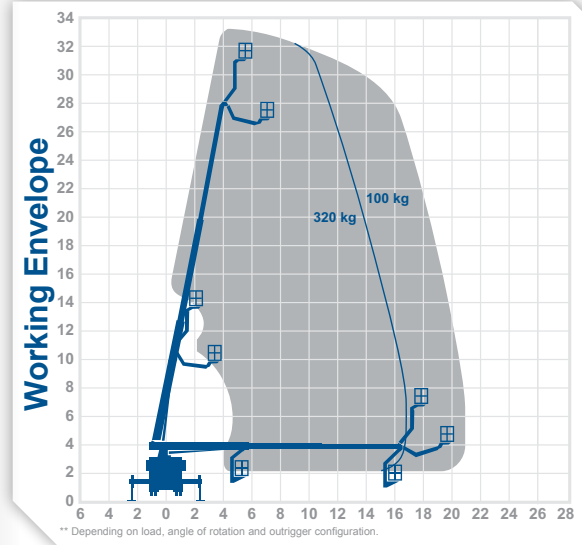

0345 745 0000  
nationwideplatforms.co.uk



**Nationwide Platforms**  
A Loxam Company





**Working Height** 37.0m  
**Outreach\*\*** 30.0m (100kg)

Max Horiz. Outreach (full SWL)	21.0m
Max Reach Below 0m	6.0m
Overall Travel Length	8.9m
Overall Travel Height	3.9m
Overall Travel Width	2.55m
Platform Cage Size (extended)	2.3(3.6)m x 0.9m
Max SWL	500kg
Gross Vehicle Weight	18000kg
Operational Full Width	6.4m
Minimum Operational Width	2.6m
Point Load Front / Rear	170kN / 140kN

Alternative machines

T38B

Manufacturer

Ruthman

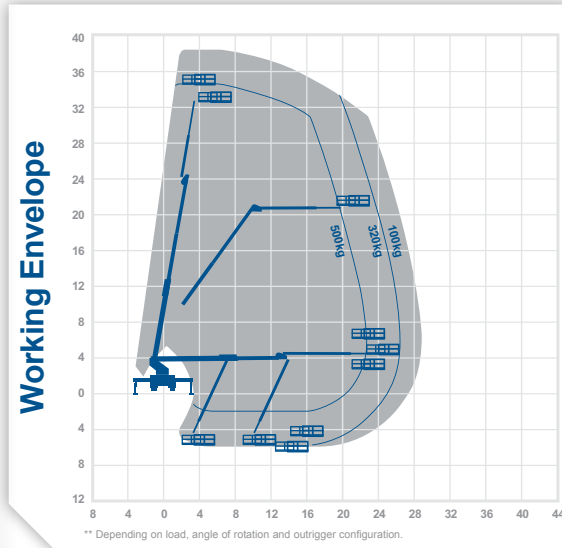

\*\* Depending on load, angle of rotation and outrigger configuration.

0345 745 0000  
[nationwideplatforms.co.uk](http://nationwideplatforms.co.uk)



**Nationwide Platforms**  
 A **LOXAM** Company

37.0m  
 30.0m



# T38B

## truck mounts

**Working Height** 38.0m  
**Outreach\*\*** 25.3m (120kg)

Max Horiz. Outreach (full SWL)	21.0m
Max Reach Below 0m	6.5m
Overall Travel Length	10.0m
Overall Travel Height	3.7m
Overall Travel Width	2.5m
Platform Cage Size (extended)	2.3(3.7)m x 1.05m
Max SWL	600kg
Gross Vehicle Weight	18000kg
Operational Full Width	6.2m
Minimum Operational Width	2.8m
Point Load Front / Rear	150kN / 150kN

### Alternative machines

T37B  
T37R

### Manufacturer

Bronto

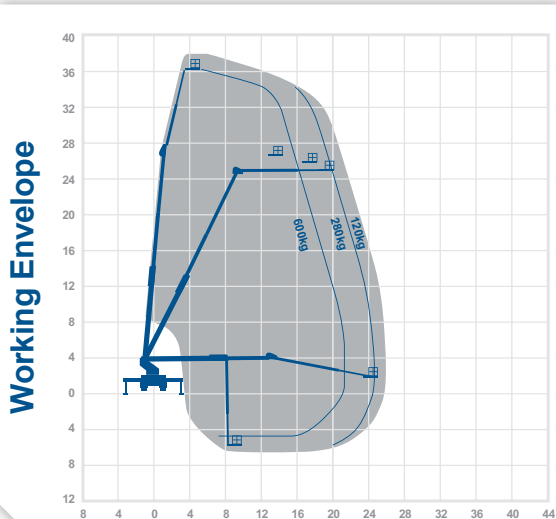

\*\* Depending on load, angle of rotation and outrigger configuration.

# T44B

## truck mounts

**Working Height** 44.0m  
**Outreach\*\*** 24.0m (120kg)

Max Horiz. Outreach (full SWL)	21.0m
Max Reach Below 0m	5.0m
Overall Travel Length	10.0m
Overall Travel Height	3.8m
Overall Travel Width	2.5m
Platform Cage Size	2.4(3.7)m x 1.0m
Max SWL	600kg
Gross Vehicle Weight	18000kg
Operational Full Width	6.2m
Minimum Operational Width	2.8m
Point Load Front / Rear	150kN / 150kN

### Alternative machines

T46B

### Manufacturer

Bronto

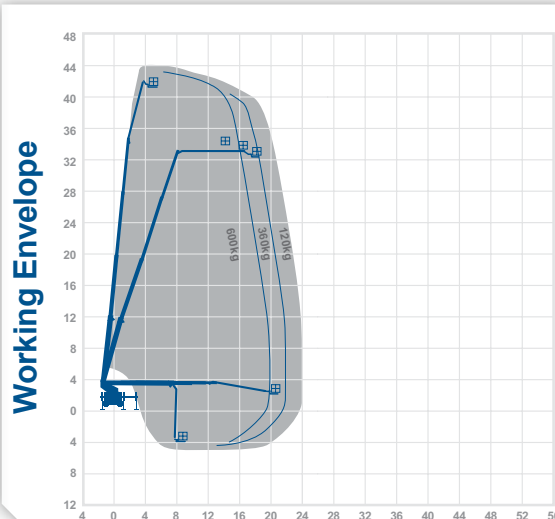

\*\* Depending on load, angle of rotation and outrigger configuration.

0345 745 0000  
nationwideplatforms.co.uk



**Nationwide Platforms**  
A **LOXAM** Company

# T46B

## truck mounts

**Working Height** 46.0m  
**Outreach\*\*** 24.5m (120kg)

Max Horiz. Outreach (full SWL)	20.0m
Max Reach Below 0m	6.5m
Overall Travel Length	10.5m
Overall Travel Height	3.7m
Overall Travel Width	2.5m
Platform Cage Size	2.47m x 1.05m
Max SWL	600kg
Gross Vehicle Weight	18000kg
Operational Full Width	6.2m
Minimum Operational Width	2.8m
Point Load Front / Rear	150kN / 150kN

**Alternative machines**

T48P  
T50JB

**Manufacturer**

Bronto



Working Envelope

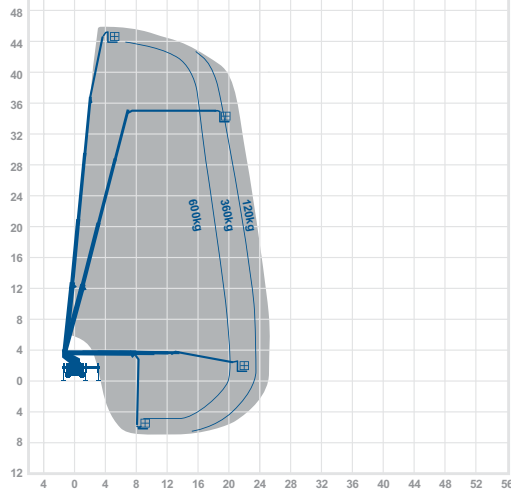

\*\* Depending on load, angle of rotation and outrigger configuration.

# T48P

## truck mounts

**Working Height** 48.0m  
**Outreach\*\*** 28.0m (100kg)

Max Horiz. Outreach (full SWL)	22.0m
Max Reach Below 0m	13.5m
Overall Travel Length	10.4m
Overall Travel Height	4.0m
Overall Travel Width	2.55m
Platform Cage Size (extended)	2.15(3.8)m x 1.05m
Max SWL	600kg
Gross Vehicle Weight	17600kg
Operational Full Width	6.3m
Minimum Operational Width	2.55m
Point Load Front / Rear	160kN / 160kN

**Alternative machines**

T50JB

**Manufacturer**

Palfinger



Working Envelope

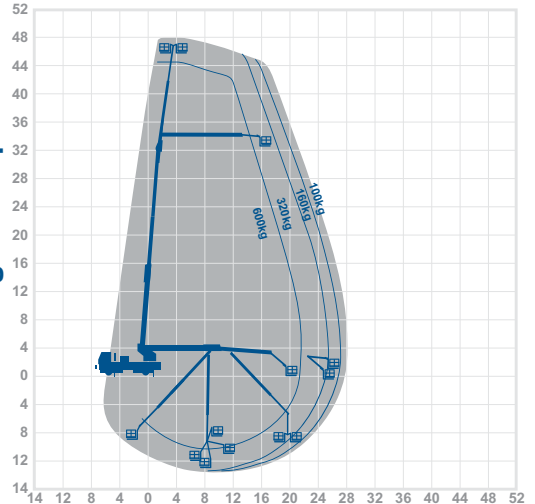

\*\* Depending on load, angle of rotation and outrigger configuration.

**0345 745 0000**  
**nationwideplatforms.co.uk**



**Nationwide Platforms**  
A **LOXAM** Company

# T50JB

truck  
mounts

**Working Height** 50.0m  
**Outreach\*\*** 35.0m (120kg)

Max Horiz. Outreach (full SWL)	25.0m
Max Reach Below 0m	11.0m
Overall Travel Length	12.0m
Overall Travel Height	4.0m
Overall Travel Width	2.5m
Platform Cage Size (extended)	2.2(3.7)m x 0.9m
Max SWL	600kg
Gross Vehicle Weight	26000kg
Operational Full Width	8.0m
Minimum Operational Width	2.8m
Point Load Front / Rear	190kN / 190kN

Alternative machines

T58B  
T48P  
T56B

**Manufacturer**

Bronto

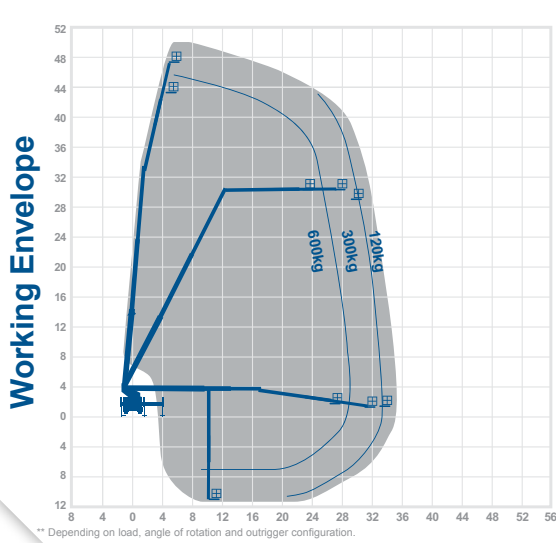

\*\* Depending on load, angle of rotation and outrigger configuration.

# T56B-XR

truck  
mounts

**Working Height** 56.0m  
**Outreach\*\*** 37.3m (200kg)

Max Horiz. Outreach (full SWL)	32.0m
Max Reach Below 0m	9.0m
Overall Travel Length	11.9m
Overall Travel Height	3.7m
Overall Travel Width	2.5m
Platform Cage Size (extended)	2.4(3.7)m x 1.0m
Max SWL	600kg
Gross Vehicle Weight	26000kg
Operational Full Width	9.0m
Minimum Operational Width	3.0m
Point Load Front / Rear	180kN / 180kN

Alternative machines

T50JB

**Manufacturer**

Bronto

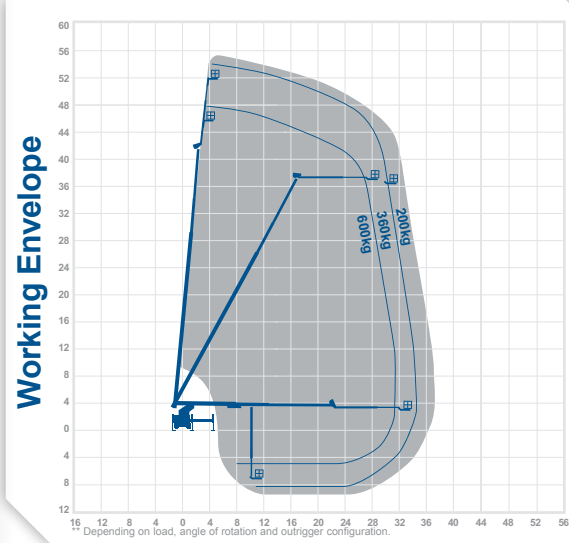

\*\* Depending on load, angle of rotation and outrigger configuration.

0345 745 0000  
nationwideplatforms.co.uk



**Nationwide Platforms**  
A Loxam Company

# T58R

truck  
mounts

**Working Height** 58.0m  
**Outreach\*\*** 38.0m (100kg)

Max Horiz. Outreach (full SWL)	31.0m
Max Reach Below 0m	6.0m
Overall Travel Length	11.7m
Overall Travel Height	3.99m
Overall Travel Width	2.55m
Platform Cage Size (extended)	2.3(3.6)m x 0.9m
Max SWL	500kg
Gross Vehicle Weight	26000kg
Operational Full Width	9.67m
Minimum Operational Width	2.85m
Point Load Front / Rear	220kN / 220kN

Alternative machines

T70B  
T66M-1  
T56B

Manufacturer

Ruthman



Working Envelope

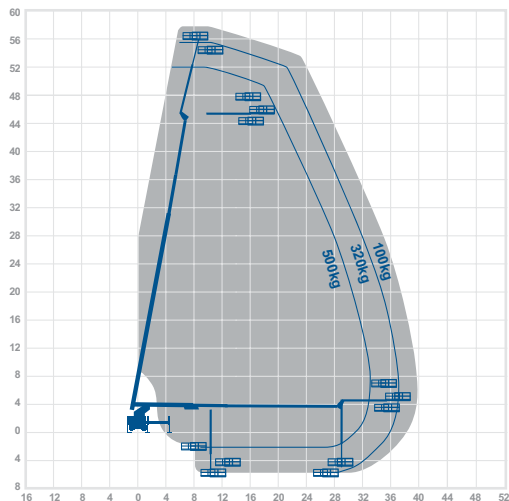

\*\* Depending on load, angle of rotation and outrigger configuration.

# T70B

truck  
mounts

**Working Height** 70.0m  
**Outreach** 34.8m (120kg)

Max Horiz. Outreach (full SWL)	30.0m
Max Reach Below 0m	6.0m
Overall Travel Length	12.5m
Overall Travel Height	4.2m
Overall Travel Width	2.5m
Platform Cage Size (extended)	2.4(3.7)m x 1.0m
Max SWL	600kg
Gross Vehicle Weight	36000kg
Operational Full Width	8.0m
Minimum Operational Width	3.2m
Point Load Front / Rear	255kN / 255kN

Alternative machines

T90B

Manufacturer

Bronto

Cage winch option available  
Extra capacity basket available 2020



Working Envelope

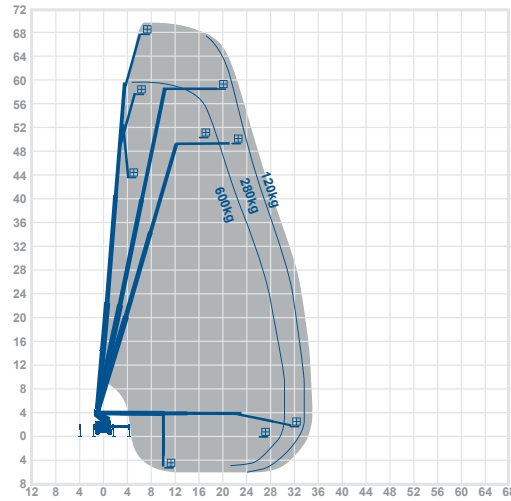

0345 745 0000  
nationwideplatforms.co.uk



**Nationwide Platforms**  
A **LOXAM** Company

# T70B-XR

truck  
mounts

# T90B

truck  
mounts

**Working Height 70.0m**  
**Outreach 34.8m (200kg)**

Max Horiz. Outreach (full SWL)	30.0m
Max Reach Below 0m	11.0m
Overall Travel Length	12.0m
Overall Travel Height	3.9m
Overall Travel Width	2.4m
Platform Cage Size (extended)	2.4m(3.7m) x 1.0m
Max SWL	600kg
Gross Vehicle Weight	36000kg
Operational Full Width	8.0m
Minimum Operational Width	3.2m
One sided jacking	5.6 m
Point Load Front / Rear	230 kN / 230 kN

Alternative machines  
T70B

Manufacturer  
Bronto

Cage winch  
option available



**Working Height 90.0m**  
**Outreach\*\* 31.0m (400kg)**

Max Horiz. Outreach (full SWL)	29.0m
Max Reach Below 0m	12.0m
Overall Travel Length	15.6m
Overall Travel Height	4.0m
Overall Travel Width	2.5m
Platform Cage Size (extended)	2.4(3.7)m x 1.0m
Max SWL	600kg
Gross Vehicle Weight	48000kg
Operational Full Width	7.0m
Minimum Operational Width	n/a
Point Load Front / Rear	270kN / 270kN

Alternative machines  
T70B

Manufacturer  
Bronto

Cage winch  
option available



Working Envelope

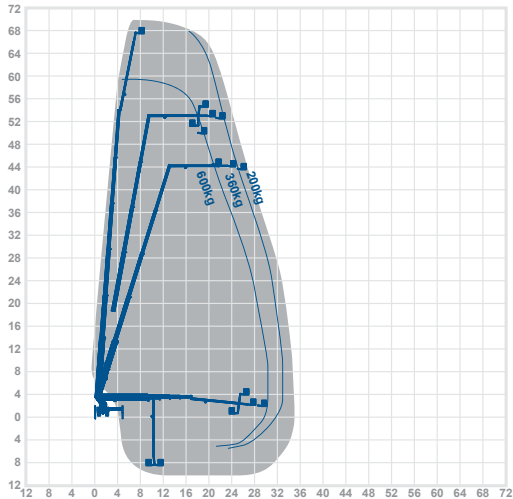

Working Envelope

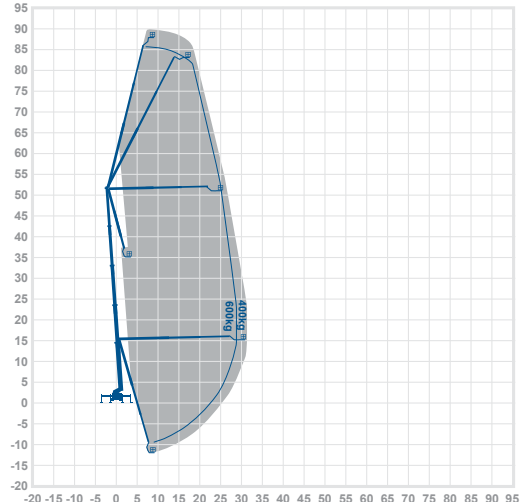

\*\* Depending on load, angle of rotation and outrigger configuration.

0345 745 0000  
nationwideplatforms.co.uk



Nationwide Platforms  
A LOXAM Company

# Tracked Booms



- More than 130 available to hire on either operated or self-operated basis
- Can be operated with IPAF 1b license
- Allows access to restricted areas that traditional booms can't
- Lithium battery models are available
- Reduces the ground bearing pressure on soft ground and delicate flooring
- Allows greater stability for work on uneven surfaces
- Easily transportable
- Can be used for a variety of applications including facilities management and retail
- Working heights up to 31m

## Machine type by product code

TB14HB

TB14HE

TB15HB

TB15HE

TB17HB

TB17HE

TB18PB

TB20HB

TB20HE

TB20JB

TB26HB

TB26HE

TB30MB

TB31TB



0345 745 0000  
nationwideplatforms.co.uk



 **Nationwide Platforms**  
A **LOXAM** Company

# TB14HB

tracked  
booms

**Working Height 14.0m**

**Horizontal Outreach 7.0m**

Closed Length	4.06m
Closed Height	1.99m
Rails Up / Fixed Rails	
Closed Width	0.78m
DeckSize	1.33m x 0.69m
Rotation	360°
SWL	200kg
Weight	1750kg
Outrigger Footprint	2.7m x 2.7m
Min Op Width	2.7m

**Alternative machines**

TB14HE  
TB17HE  
TB17HB

**Manufacturer**

Hinowa

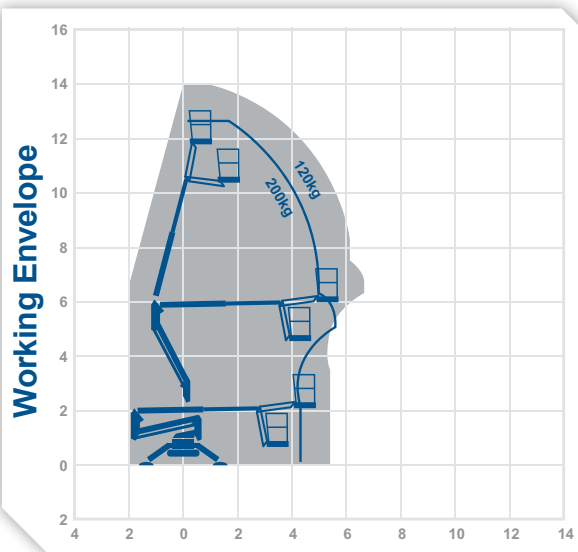

# TB14HE

tracked  
booms

**Working Height 14.0m**

**Horizontal Outreach 7.0m**

Closed Length	4.06m
Closed Height	1.99m
Rails Up / Fixed Rails	
Closed Width	0.78m
DeckSize	1.33m x 0.69m
Rotation	360°
SWL	200kg
Weight	1750kg
Outrigger Footprint	2.7m x 2.7m
Min Op Width	2.7m

**Alternative machines**

TB14HB  
TB17HE  
TB17HB

**Manufacturer**

Hinowa

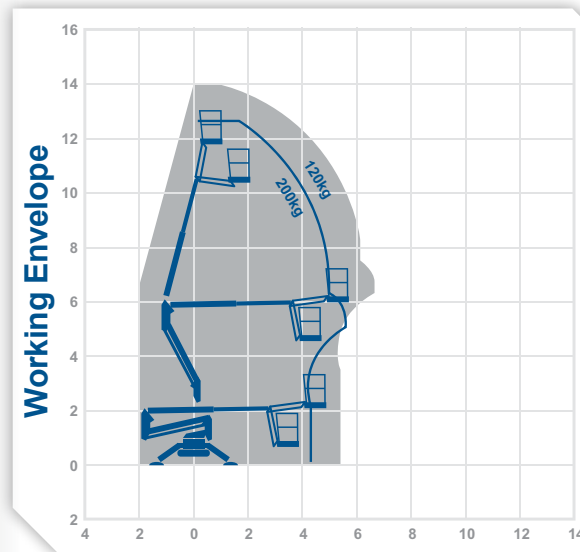

0345 745 0000  
nationwideplatforms.co.uk



**Nationwide Platforms**  
A Loxam Company

# TB15HB

tracked  
booms

**Working Height 15.4m**

**Horizontal Outreach 6.6m**

Closed Length	4.02m
Closed Height	1.99m
Rails Up / Fixed Rails	
Closed Width	0.75m
DeckSize	1.33m x 0.69m
Rotation	360°
SWL	230kg
Weight	1950kg
Outrigger Footprint	2.8m x 2.8m
Min Op Width	2.8m

**Alternative machines**

TB15HE  
TB17HE  
TB17HB

**Manufacturer**

Hinowa

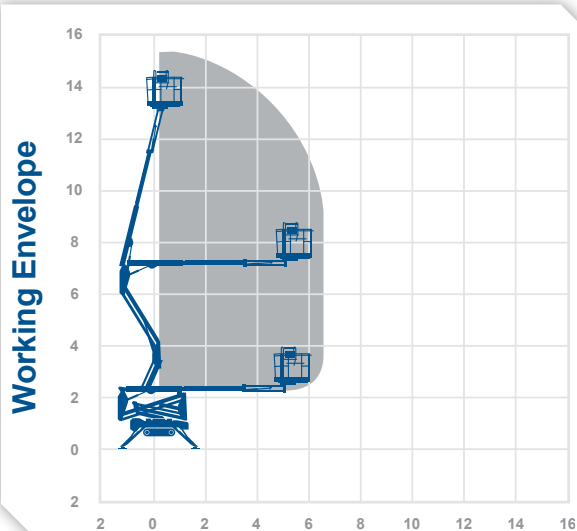

**0345 745 0000**  
[nationwideplatforms.co.uk](http://nationwideplatforms.co.uk)



# TB15HE

tracked  
booms

**Working Height 15.4m**

**Horizontal Outreach 6.6m**

Closed Length	4.02m
Closed Height	1.99m
Rails Up / Fixed Rails	
Closed Width	0.75m
DeckSize	1.33m x 0.69m
Rotation	360°
SWL	230kg
Weight	1950kg
Outrigger Footprint	2.8m x 2.8m
Min Op Width	2.8m

**Alternative machines**

TB15HB  
TB17HE  
TB17HB

**Manufacturer**

Hinowa

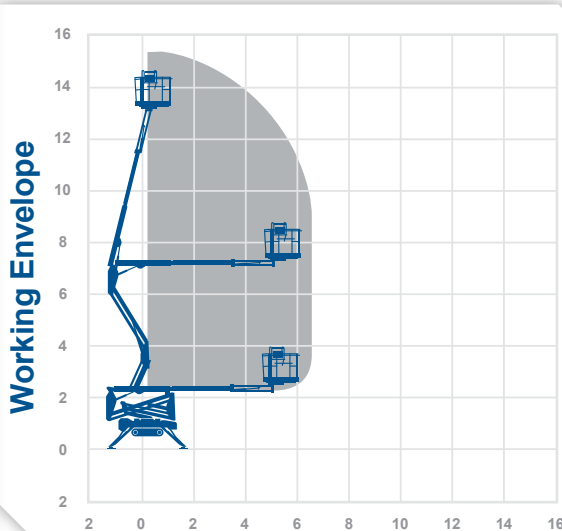

**Nationwide Platforms**  
A **LOXAM** Company



# TB17HB

tracked  
booms

**Working Height 17.06m**

**Horizontal Outreach 7.5m**

Closed Length	4.52m
Closed Height	2.0m
Rails Up / Fixed Rails	
Closed Width	0.79m
DeckSize	1.33m x 0.69m
Rotation	360°
SWL	230kg
Weight	2280kg
Outrigger Footprint	2.88m x 2.89m
Min Op Width	2.88m

**Alternative machines**

TB17HE  
TB20HE  
TB20HB

**Manufacturer**

Hinowa

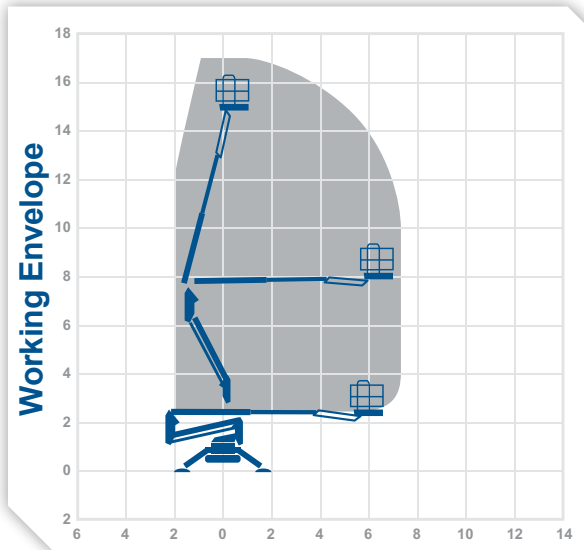

# TB17HE

tracked  
booms

**Working Height 17.06m**

**Horizontal Outreach 7.5m**

Closed Length	4.52m
Closed Height	2.0m
Rails Up / Fixed Rails	
Closed Width	0.79m
DeckSize	1.33m x 0.69m
Rotation	360°
SWL	230kg
Weight	2280kg
Outrigger Footprint	2.88m x 2.89m
Min Op Width	2.88m

**Alternative machines**

TB17HB  
TB20HE  
TB20HB

**Manufacturer**

Hinowa

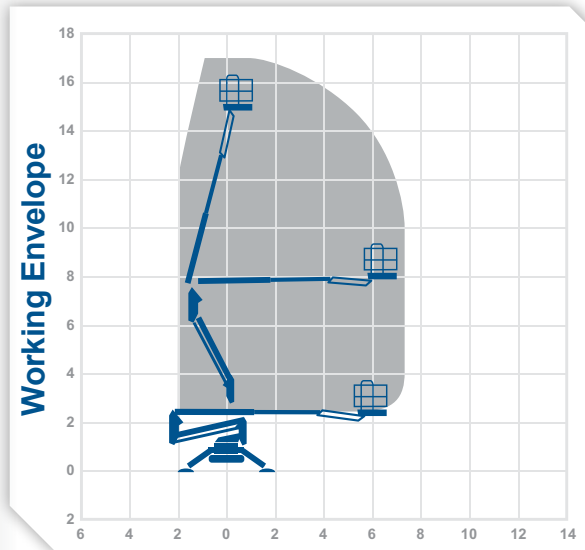

**0345 745 0000**  
[nationwideplatforms.co.uk](http://nationwideplatforms.co.uk)



**Nationwide Platforms**  
A **LOXAM** Company

# TB18PB

tracked  
booms

**Working Height 17.6m**

**Horizontal Outreach 9.2m**

Closed Length	5.21m
Closed Height	1.95m
Rails Up / Fixed Rails	
Closed Width	0.78m
DeckSize	1.3m x 0.7m
Rotation	360°
SWL	200kg
Weight	2350kg
Outrigger Footprint	3.1m x 3.1m
Min Op Width	3.1m

**Alternative machines**

TB17HE  
TB20HE  
TB20HB

**Manufacturer**

Hinowa

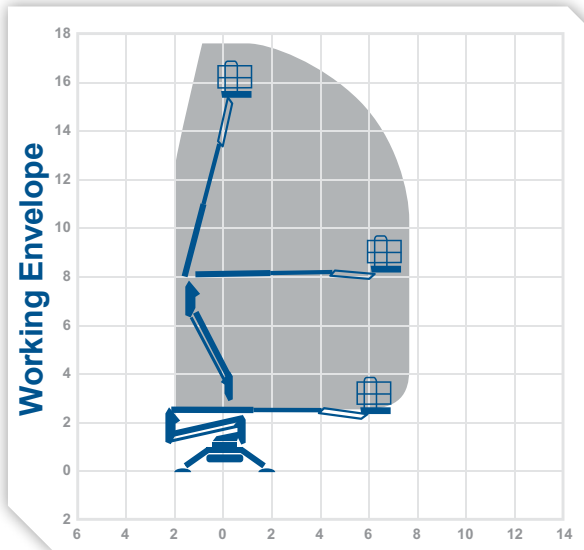

**0345 745 0000**  
[nationwideplatforms.co.uk](http://nationwideplatforms.co.uk)



# TB20HB

tracked  
booms

**Working Height 20.1m**

**Horizontal Outreach 9.7m**

Closed Length	5.01m
Closed Height	1.99m
Rails Up / Fixed Rails	
Closed Width	0.79m
DeckSize	1.33m x 0.69m
Rotation	360°
SWL	230kg
Weight	2880kg
Outrigger Footprint	2.92m x 2.92m
Min Op Width	2.92m

**Alternative machines**

TB26HE  
TB26HB  
TB20HE

**Manufacturer**

Hinowa

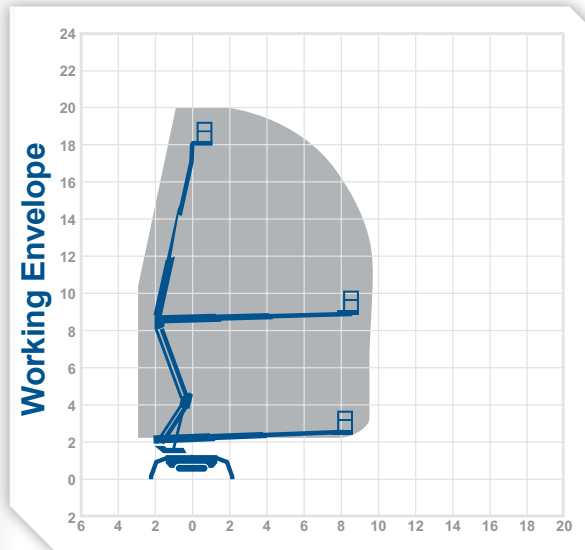

**Nationwide Platforms**  
A **LOXAM** Company

# TB20HE

tracked  
booms

**Working Height 20.1m**

**Horizontal Outreach 9.7m**

Closed Length	5.01m
Closed Height	1.99m
Rails Up / Fixed Rails	
Closed Width	0.79m
DeckSize	1.33m x 0.69m
Rotation	360°
SWL	230kg
Weight	2880kg
Outrigger Footprint	2.92m x 2.92m
Min Op Width	2.92m

**Alternative machines**

TB26HE  
TB26HB  
TB17HB  
TB20HB

**Manufacturer**

Hinowa

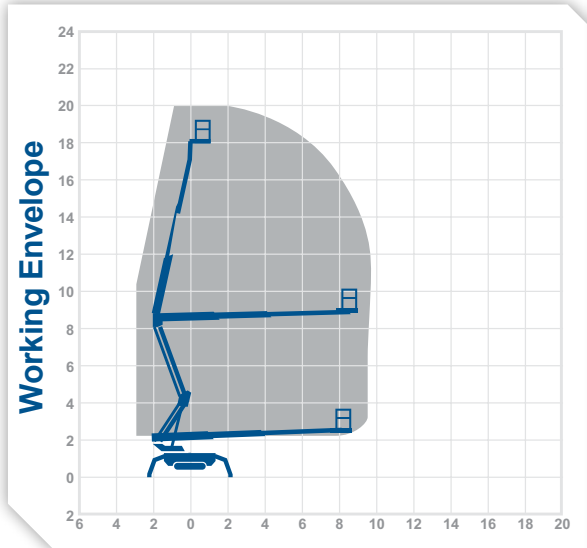

# TB20JB

tracked  
booms

**Working Height 20.1m**

**Horizontal Outreach 9.7m**

Closed Length	5.01m
Closed Height	1.99m
Rails Up / Fixed Rails	
Closed Width	0.79m
DeckSize	1.33m x 0.69m
Rotation	360°
SWL	230kg
Weight	2880kg
Outrigger Footprint	2.92m x 2.92m
Min Op Width	2.92m

**Alternative machines**

TB26HE  
TB26HB  
TB17HB  
TB20HB

**Manufacturer**

Hinowa

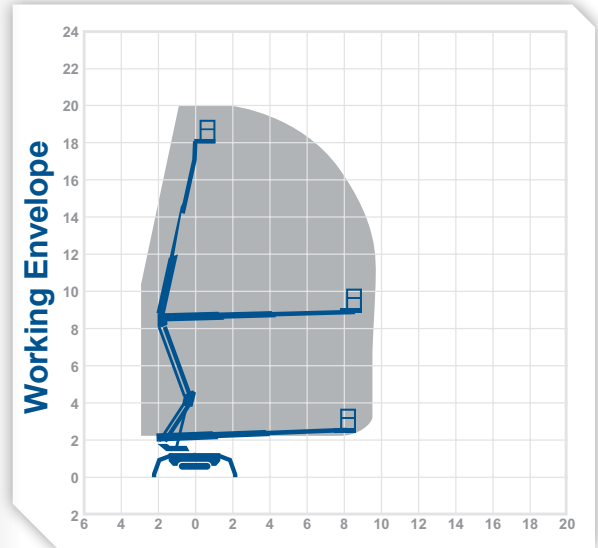

**0345 745 0000**  
[nationwideplatforms.co.uk](http://nationwideplatforms.co.uk)



**Nationwide Platforms**  
A **LOXAM** Company

# TB26HB

tracked  
booms

**Working Height 25.7m**

**Horizontal Outreach 13.6m**

Closed Length	6.34m
Closed Height	1.98m
Rails Up / Fixed Rails	
Closed Width	0.99m
DeckSize	1.33m x 0.69m
Rotation	360°
SWL	230kg
Weight	4415kg
Outrigger Footprint	4.07m x 3.97m
Min Op Width	3.97m

Alternative machines

TB26HE

Manufacturer

Hinowa

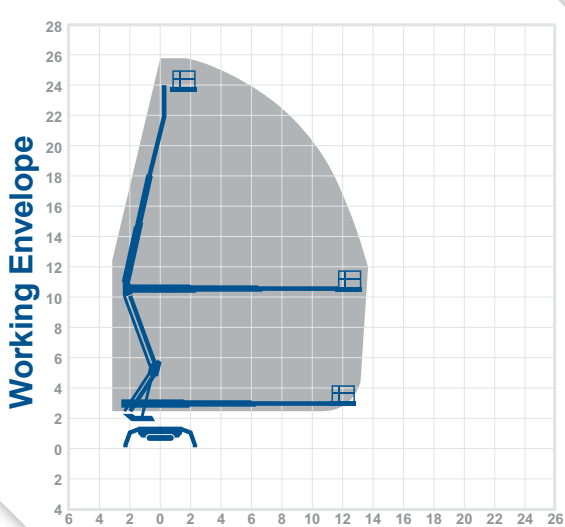

# TB26HE

tracked  
booms

**Working Height 25.7m**

**Horizontal Outreach 13.6m**

Closed Length	6.34m
Closed Height	1.98m
Rails Up / Fixed Rails	
Closed Width	0.99m
DeckSize	1.33m x 0.69m
Rotation	360°
SWL	230kg
Weight	4415kg
Outrigger Footprint	4.07m x 3.97m
Min Op Width	3.97m

Alternative machines

TB26HB

Manufacturer

Hinowa

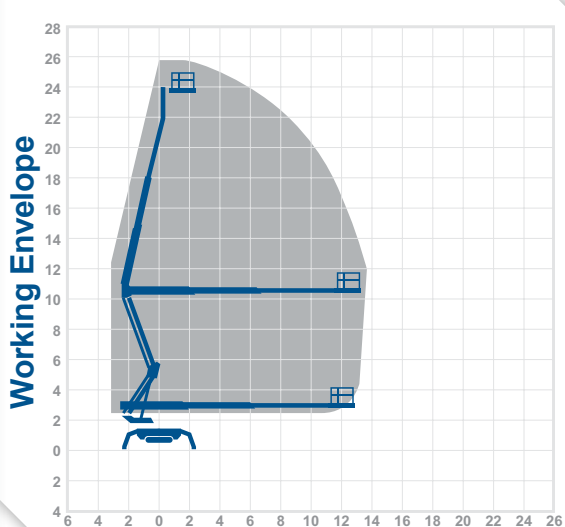

0345 745 0000  
nationwideplatforms.co.uk



**Nationwide Platforms**  
A **LOXAM** Company

# TB30MB

tracked  
booms

**Working Height 30m**  
**Horizontal Outreach 14m**

Closed Length	6.65m
Closed Height	2.3m
Closed Width	1.6m
Platform Size	0.70m x 1.60m
Rotation	400°
Max SWL	270kg
Weight	5600kg
Min Op Width	3.3m

Alternative machines

TB31TB

Manufacturer

Multitel

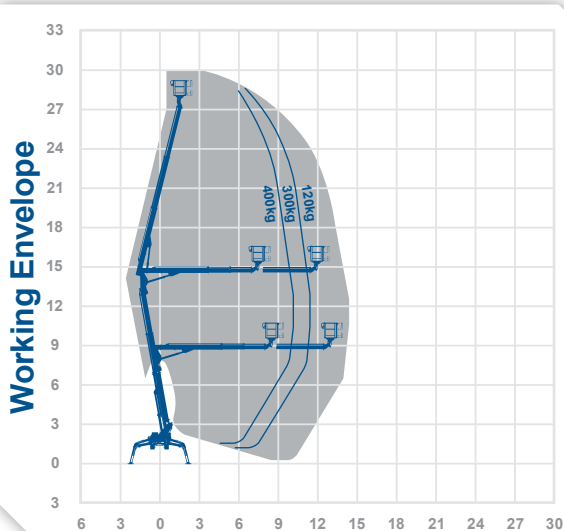

**0345 745 0000**  
**nationwideplatforms.co.uk**



# TB31TB

tracked  
booms

**Working Height 31.0m**  
**Horizontal Outreach 14.7m**

Closed Length	7.23m
Closed Height	1.98m
Rails Up / Fixed Rails	
Closed Width	1.58m
DeckSize	1.20m x 0.80m
Rotation	360°
SWL	250kg
Weight	4350kg
Outrigger Footprint	5.45m x 5.15m
Min Op Width	2.75m

Alternative machines

TB26HB  
TB26HE

Manufacturer

Teupen

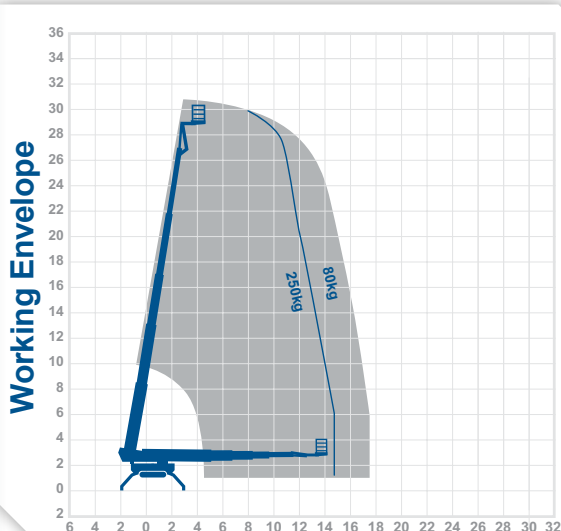

**Nationwide Platforms**  
A **LOXAM** Company

# Telehandlers



- Access to the UK's largest fleet of telehandlers
- Full range from compact 4m machines to 30m rotational telehandlers
- Rough terrain forklift
- Ideal for lifting heavy materials to height

## Machine type by product code

JCB520-40	JCB535-140
JCB520-50	HTL4017
JCB525-60	JCB540-170
JCB531-70	JCB540-200
JCB3070	MRT2150
JCB926	ROTO6024
JCB533-105	MRT2540
JCB535-125	ROTO4026
HTL4014	ROTO4030



**0345 745 0000**  
**nationwideplatforms.co.uk**



**Nationwide Platforms**  
A **LOXAM** Company



**Max Lift Height** 4.0m  
**Max Forward Reach** 2.59m

Manufacturer  
 JCB

Overall Length 2.92m  
 Overall Height 1.97m  
 Overall Width 1.56m  
 Max Capacity 2000kg  
 Max Lift Capacity (full reach) 1000kg  
 Weight 4400kg  
 Outside Turn Radius 3.05m

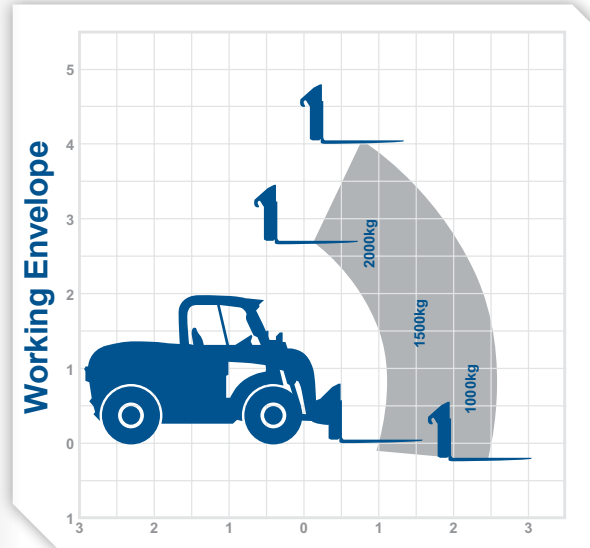

0345 745 0000  
[nationwideplatforms.co.uk](http://nationwideplatforms.co.uk)



**Nationwide Platforms**  
 A **LOXAM** Company

2.59m 4.0m

# JCB520-50

## telehandlers

**Max Lift Height** 5.0m  
**Max Forward Reach** 2.82m

Overall Length 3.08m  
Overall Height 2.12m  
Overall Width 1.84m  
Max Capacity 2000kg  
Max Lift Capacity (full reach) 750kg  
Weight 4870kg  
Outside Turn Radius 3.1m

Manufacturer  
JCB

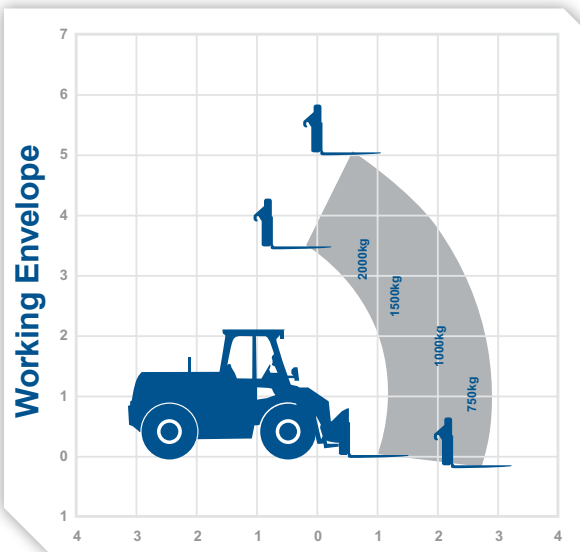

0345 745 0000  
nationwideplatforms.co.uk



# JCB525-60

## telehandlers

**Max Lift Height** 6.0m  
**Max Forward Reach** 3.06m

Overall Length 3.38m  
Overall Height 1.89m  
Overall Width 1.84m  
Max Capacity 2500kg  
Max Lift Capacity (full reach) 1750kg  
Weight 5490kg  
Outside Turn Radius 3.71m

Manufacturer  
JCB

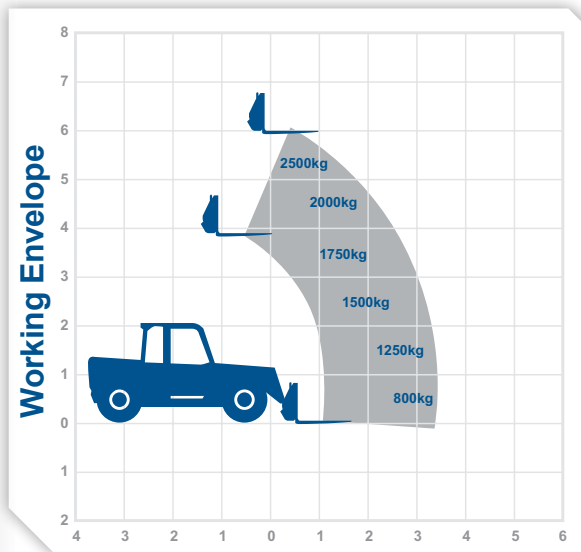

Nationwide Platforms  
A Loxam Company



# JCB531-70

## telehandlers

**Max Lift Height 7.0m**  
**Max Forward Reach 3.7m**

Overall Length 4.38m  
 Overall Height 2.49m  
 Overall Width 2.23m  
 Max Capacity 3500kg  
 Max Lift Capacity (full reach) 2400kg  
 Weight 7060kg  
 Outside Turn Radius 3.7m

Manufacturer  
 JCB

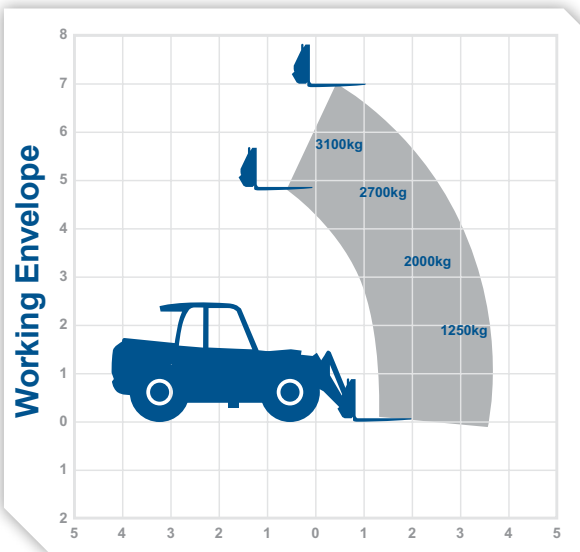

**0345 745 0000**  
**nationwideplatforms.co.uk**

# JCB3070

## telehandlers

**Max Lift Height 7.0m**  
**Max Forward Reach 3.7m**

Overall Length 4.99m  
 Overall Height 2.49m  
 Overall Width 2.23m  
 Max Capacity 3000kg  
 Max Lift Capacity (full reach) 1250kg  
 Weight 6900kg  
 Outside Turn Radius 3.7m

Manufacturer  
 JCB

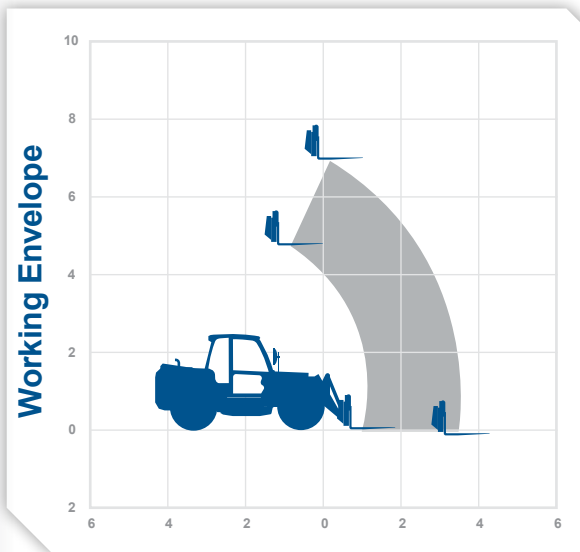

**Nationwide Platforms**  
 A **LOXAM** Company



**Max Lift Height** 7.67m

**Max Forward Reach** N/A

Overall Length	3.6m
Overall Height	2.57m
Overall Width	2.2m
Max Capacity	3000kg
Max Lift Capacity (full reach)	2600kg
Weight	5910kg
Outside Turn Radius	4.49m

Manufacturer  
JCB

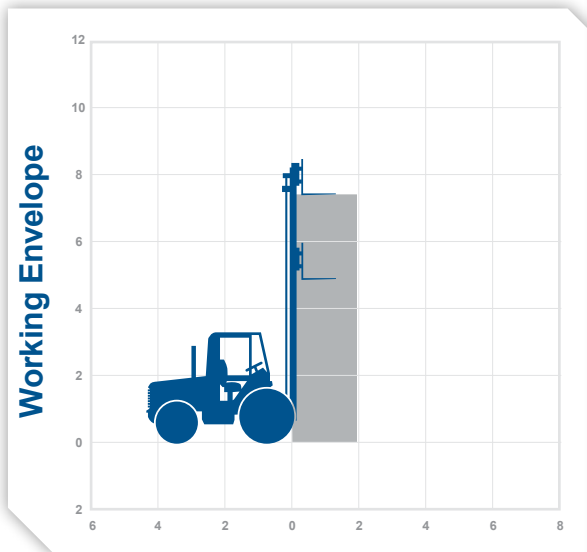

**Max Lift Height** 10.2m

**Max Forward Reach** 6.83m

Overall Length	4.38m
Overall Height	2.49m
Overall Width	2.29m
Max Capacity	3300kg
Max Lift Capacity (full reach)	1000kg
Weight	8850kg
Outside Turn Radius	3.7m

Manufacturer  
JCB

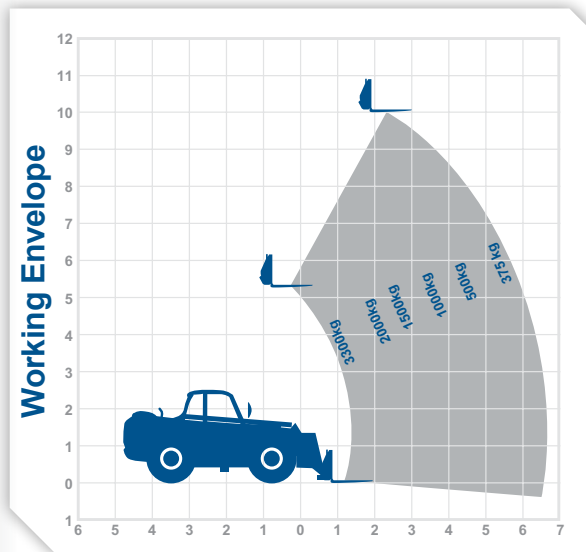

**0345 745 0000**  
nationwideplatforms.co.uk



**Nationwide Platforms**  
A **LOXAM** Company

**Max Lift Height** 12.28m  
**Max Forward Reach** 8.1m

Overall Length 5.8m  
 Overall Height 2.59m  
 Overall Width 2.35m  
 Max Capacity 3500kg  
 Max Lift Capacity (full reach) 1150kg  
 Weight 10066kg  
 Outside Turn Radius 3.75m

Manufacturer  
 JCB

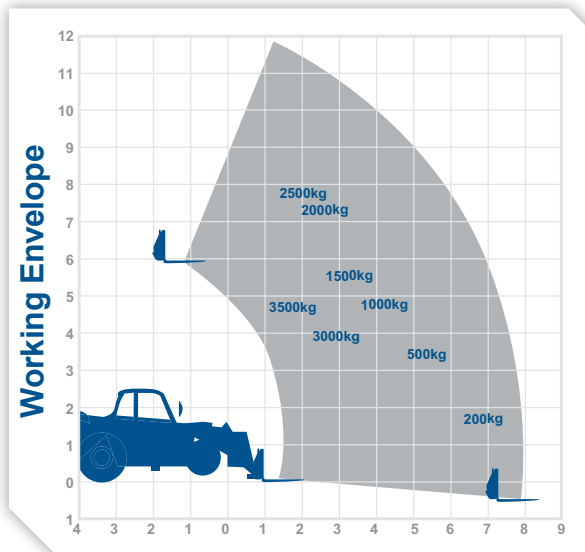

**0345 745 0000**  
[nationwideplatforms.co.uk](http://nationwideplatforms.co.uk)



**Max Lift Height** 13.6m  
**Max Forward Reach** 9.8m

Overall Length 6.46m  
 Overall Height 2.6m  
 Overall Width 2.43m  
 Max Capacity 4000kg  
 Max Lift Capacity (full reach) 1000kg  
 Weight 10710kg  
 Outside Turn Radius 4.5m

Manufacturer  
 Haulotte

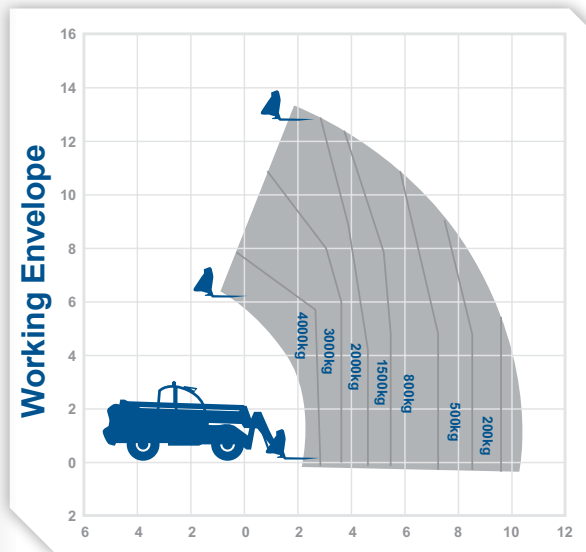

**Nationwide Platforms**  
 A **LOXAM** Company

**Max Lift Height** 13.78m

**Max Forward Reach** 9.7m

Overall Length	6.23m
Overall Height	2.59m
Overall Width	2.35m
Max Capacity	3500kg
Max Lift Capacity (full reach)	1250kg
Weight	11090kg
Outside Turn Radius	4.1m

Manufacturer  
JCB

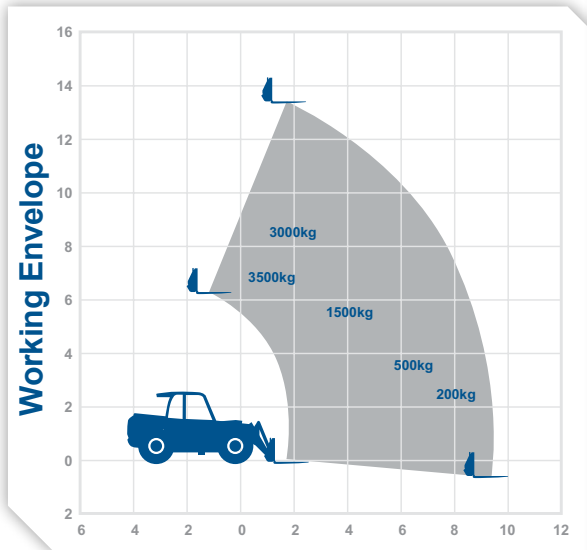

**0345 745 0000**  
[nationwideplatforms.co.uk](http://nationwideplatforms.co.uk)



**Max Lift Height** 16.7m

**Max Forward Reach** 12.9m

Overall Length	6.65m
Overall Height	2.6m
Overall Width	2.43m
Max Capacity	4000kg
Max Lift Capacity (full reach)	700kg
Weight	12000kg
Outside Turn Radius	4.5m

Manufacturer  
Haulotte

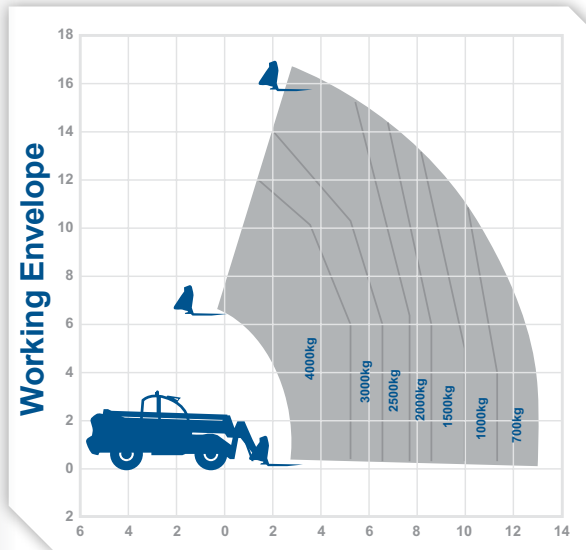

**Nationwide Platforms**  
A **LOXAM** Company

# JCB540-170

telehandlers

**Max Lift Height** 16.7m

**Max Forward Reach** 12.5m

Overall Length	6.36m
Overall Height	2.69m
Overall Width	2.44m
Max Capacity	4000kg
Max Lift Capacity (full reach)	2500kg
Weight	12060kg
Outside Turn Radius	4.1m

Manufacturer  
JCB

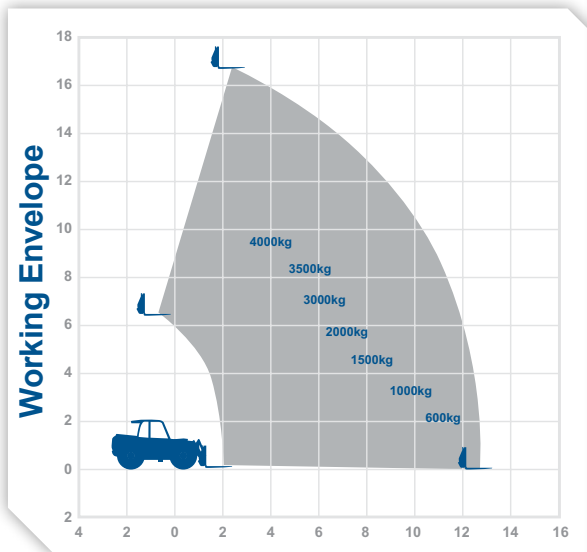

0345 745 0000  
nationwideplatforms.co.uk



# JCB540-200

telehandlers

**Max Lift Height** 20.0m

**Max Forward Reach** 15.9m

Overall Length	6.81m
Overall Height	2.72m
Overall Width	2.44m
Max Capacity	4000kg
Max Lift Capacity (full reach)	200kg
Weight	12985kg
Outside Turn Radius	4.1m

Manufacturer  
JCB

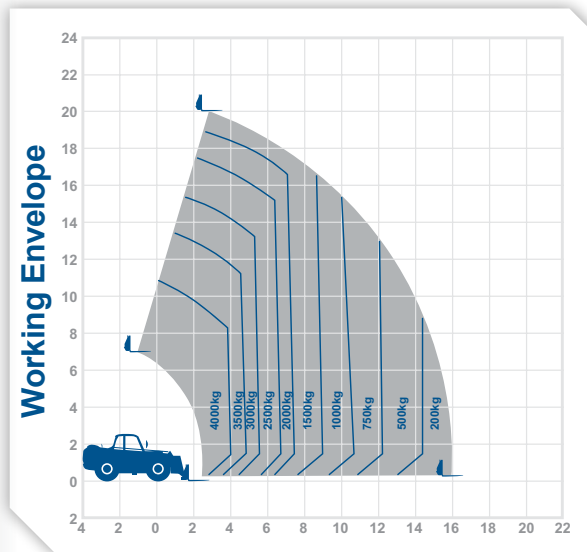

Nationwide Platforms  
A Loxam Company

# MRT2150

## telehandlers

**Max Lift Height** 20.6m

**Max Forward Reach** 18.1m

Overall Length 6.78m  
 Overall Height 3.05m  
 Overall Width 2.43m  
 Max Capacity 4999kg  
 Max Lift Capacity (full reach) 600kg  
 Weight 16095kg  
 Outside Turn Radius 4.04m

Manufacturer  
 Manitou

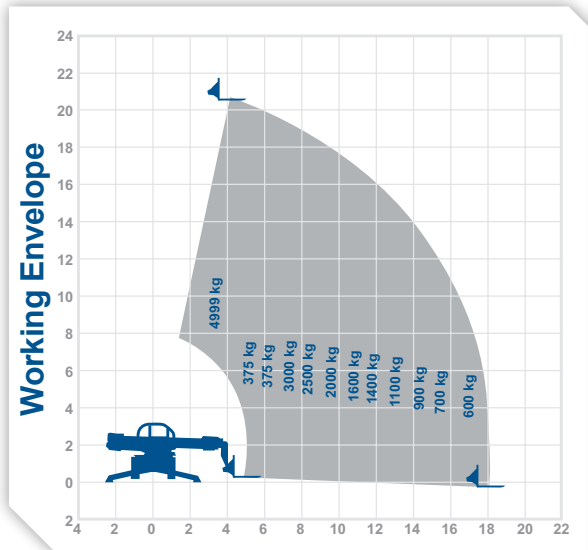

**0345 745 0000**  
[nationwideplatforms.co.uk](http://nationwideplatforms.co.uk)



# ROTO6024

## telehandlers

**Max Lift Height** 23.9m

**Max Forward Reach** 20.8m

Overall Length 7.43m  
 Overall Height 3.1m  
 Overall Width 2.49m  
 Max Capacity 6000kg  
 Max Lift Capacity (full reach) 850kg  
 Weight 18750kg  
 Outside Turn Radius 6.5m

Manufacturer  
 Merlo

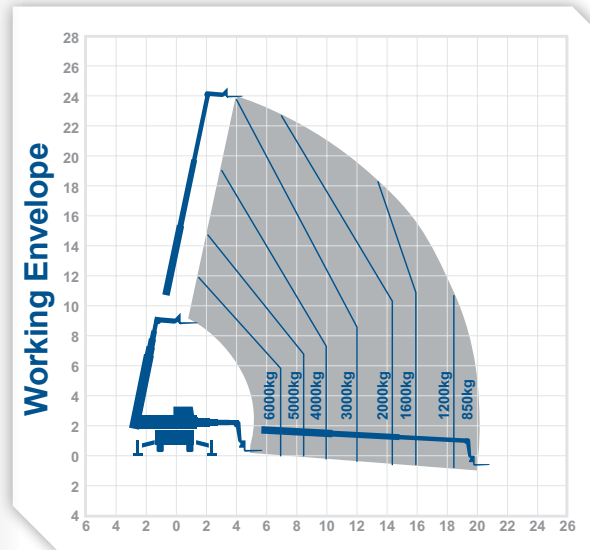

**Nationwide Platforms**  
 A **LOXAM** Company

# MRT2540

# telehandlers

**Max Lift Height** 24.6m  
**Max Forward Reach** 18.5m

Overall Length 7.82m  
 Overall Height 3.05m  
 Overall Width 2.43m  
 Max Capacity 4000kg  
 Max Lift Capacity (full reach) 400kg  
 Weight 17165kg  
 Outside Turn Radius 4.04m

Manufacturer  
 Manitou

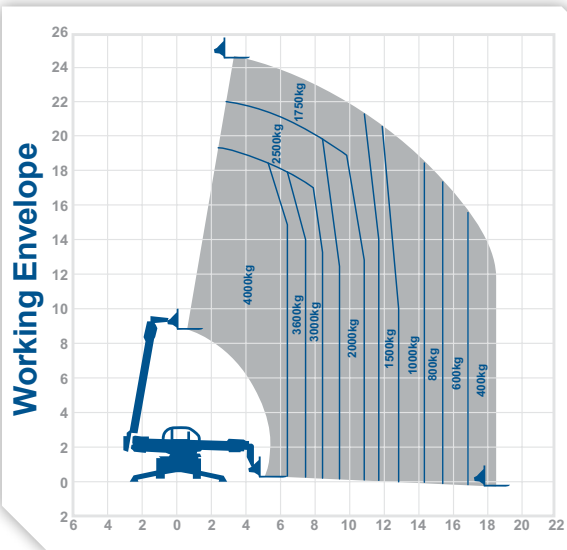

**0345 745 0000**  
[nationwideplatforms.co.uk](http://nationwideplatforms.co.uk)



# ROTO4026

# telehandlers

**Max Lift Height** 26.0m  
**Max Forward Reach** 22.9m

Overall Length 6.98m  
 Overall Height 2.95m  
 Overall Width 2.4m  
 Max Capacity 4000kg  
 Max Lift Capacity (full reach) 150kg  
 Weight 16050kg  
 Outside Turn Radius 6.85m

Manufacturer  
 Merlo

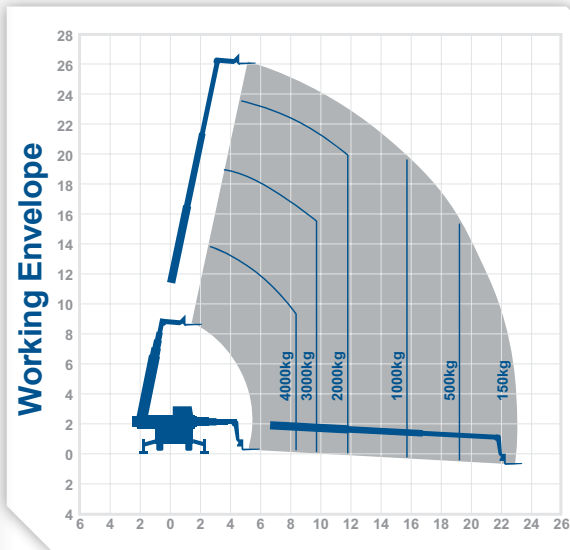

**Nationwide Platforms**  
 A **LOXAM** Company

**Max Lift Height** 29.5m  
**Max Forward Reach** 25.5m

Overall Length 7.56m  
 Overall Height 3.1m  
 Overall Width 2.49m  
 Max Capacity 4000kg  
 Max Lift Capacity (full reach) 400kg  
 Weight 19200kg  
 Outside Turn Radius 6.7m

Manufacturer  
 Merlo



RT<sup>4</sup>

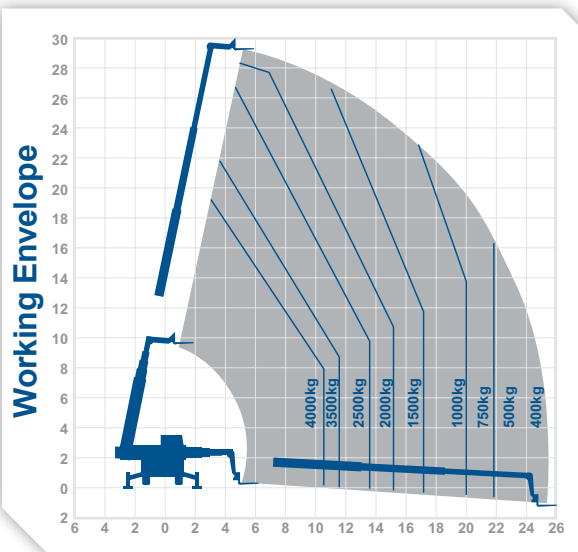

**0345 745 0000**  
[nationwideplatforms.co.uk](http://nationwideplatforms.co.uk)



**Nationwide Platforms**  
 A **LOXAM** Company



# Safety Solutions, Attachments & Accessories



## Safety and Productivity Innovation

Available exclusively through Nationwide Platforms, our BlueSky innovations can help bring new levels of productivity and safety to your project.

- Available to hire and pre-fitted with all applicable Nationwide Platforms equipment
- Enables users to conform to contractor specific mandates surrounding key safety issues
- Material handling solutions designed to boost efficiencies and convenience whilst tackling risks associated with manual handling
- For bespoke solutions please speak to your account manager

### Machine type by product code

Solo-Gyps	SkyScreen™
SkySiren®	SkyRak Edge™
SkySiren® PCS™	SkyTel
SkySentry™	SkyRakTether™
SkyRak®	SkyShield
SkyRakPlus®	Accessories
SkyRakBoom®	

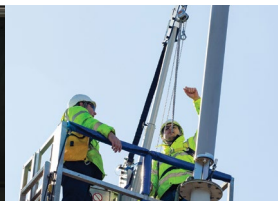

0345 745 0000  
nationwideplatforms.co.uk



**Nationwide Platforms**  
A **LOXAM** Company

Nationwide Platforms can now offer the UK's first drywall MEWP attachment. Solo-Gyps has been designed solely for use with the 4.9m Leonardo HD low level access platform. Featuring a motorised track, Solo-Gyps enables the simpler positioning of plasterboard ceiling panels, saving manpower and effectively allowing one operator to lift panels without assistance. This is ideal for interior fit-out projects.

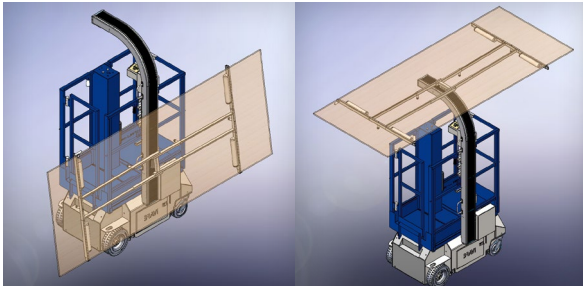

- To be used on the 4.9m Leonardo HD low level access platform only
- Three different height positions to clear even the tallest operator
- Allows one person to lift panels up to 40kg without assistance thus reducing manual handling
- Increases productivity as operators are able to fit more ceiling panels in one day
- Attachment is suitable for indoor use only

Nationwide Platforms' Secondary Guarding solution is the pioneering SkySiren®; designed to reduce the risks associated with entrapment. Not only does it stop the MEWP when an entrapment situation is detected, to prevent further crushing, it also has a flashing light and emergency klaxon to attract the attention of colleagues on the ground to enact the emergency lowering procedure without delay.



The unique pressure sensitive system, acts as an 'emergency switch' in an entrapment situation. It is designed to react to the body pressure of an operator trapped against the boom lift's control panel.

The SkySiren® is a CE Certified retro-fit system capable of being fitted to most boom-type MEWPs.



Look for the SkySiren® icon to identify which machines can benefit from this unique attachment.

In addition to the pioneering SkySiren® Nationwide Platforms have introduced the next level in safe operating at height with SkySiren®PCS™. Working in concert with SkySiren®, the SkySiren®PCS™ attachment uses proximity sensing technology to help avoid entrapment situation occurring.



The continuous operation of proximity sensors built into the SkySiren®PCS™ provides a sensing 'zone of protection', alerting the operator to potential hazards before they occur. The system has been designated as Intelligent Secondary Guarding.

The award winning design provides maximum protection, while at the same time not impeding either the MEWP's functionality nor the operators ability to carry out tasks. The SkySiren®PCS™ is CE Certified retro fit system capable of being fitted to most boom and scissor type MEWPs.



Look for the SkySiren®PCS™ icon to identify which machines can benefit from this unique attachment.

SkySentry™ is a simple and effective fleet management system designed to help you reduce costs, drive efficiency and improve safety.

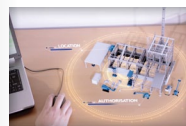

SkySentry™ is a full service system designed to improve the management of your powered access fleet across multiple sites and safeguard against unauthorised use.

The system offers unrivalled access and visibility of not only who is operating a machine at any one time. But also if they are correctly trained and authorised to do so.



Look for the SkySentry™ icon to identify which machines can benefit from this feature.

Fits most small electric scissor lifts to enable the fast and safe installation of materials up to 150kg (300kg if fitted as double and MEWP capacity allows). Materials are securely fastened using the straps provided.

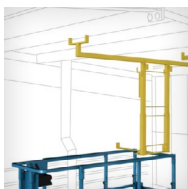

The unique design of the SkyRak® means the load weight is transferred to the platform floor, avoiding materials being rested on the non-load bearing hand-rails.

SkyRak® fits most small electric scissor lifts to enable the fast and safe installation of materials at height.



Look for the SkyRak® icon to identify which machines can benefit from this unique attachment.

SkyRakPlus® allows materials up to 600kg to be safely stored on most large decked diesel scissor lifts, with no weight put on the MEWP handrail.

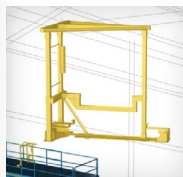
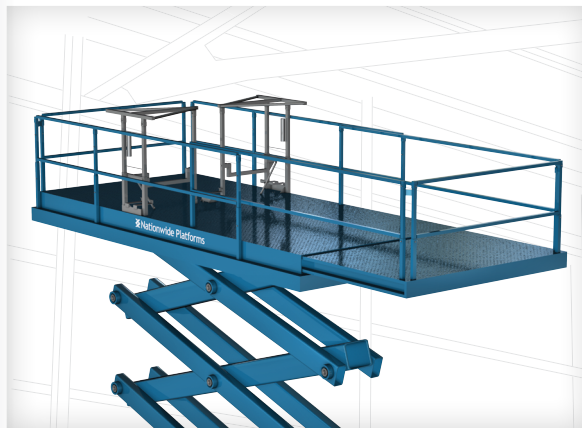

A system of flexible heads support a wide variety of materials of many shapes and sizes including pipes, ducting, cladding, steelwork and bus bars.

When the MEWP is in motion, the materials are secured by use of moveable pins and straps.



Look for the SkyRakPlus® icon to identify which machines can benefit from this unique attachment.

SkyRakBoom® allows the safe storage of materials up to 90kg in weight. Materials are stored with no weight on the MEWP's handrails.

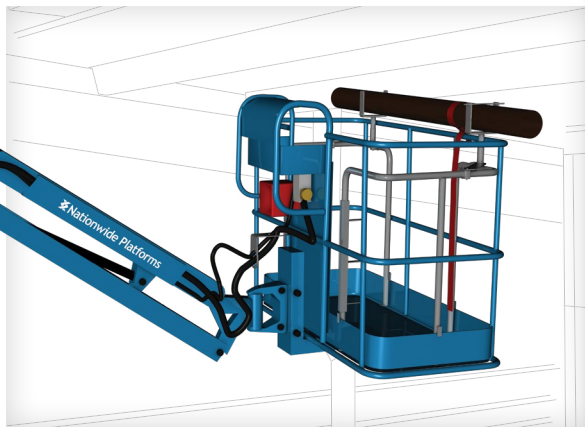

Whilst the boom is in operation, materials are safely secured using the straps provided which significantly reduces the risk of materials falling to the ground.

SkyRakBoom® is suitable for installation to all standard Genie 6ft and 8ft 'boom-type' baskets.



Look for the SkyRakBoom® icon to identify which machines can benefit from this unique attachment.

Available on the majority of our boom lifts, SkyScreen™ reduces the risk of items failing from the platform basket while also offering added protection to personnel and machines on the ground.



Velcro and magnetised fittings allow operators to assemble and remove quickly and efficiently and its design allows all normal cage operations to be unaffected. Additional features include being fire retardant and wind resistant up to 6m/s.



Look for the SkyScreen™ icon to identify which machines can benefit from this unique attachment.

SkyRakEdge™ is a lightweight material handling attachment designed to safely and securely handle scaffold tubes or lattice and ladder edge protection beams on boom type Mobile Elevated Work Platforms (MEWPs).

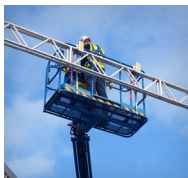
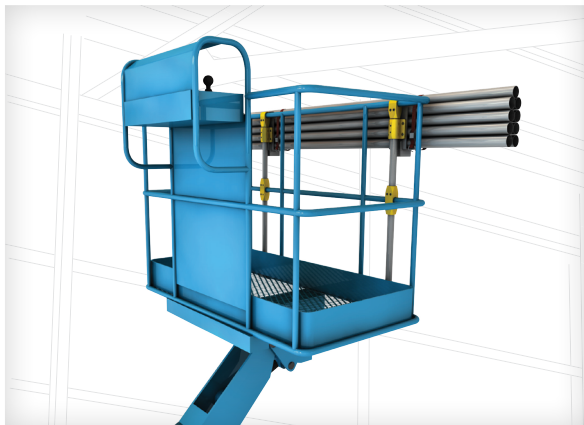

SkyRakEdge™ securely holds up to 9 x scaffold tube 6m length, or 2 x 6m lattice beams, or 1 x 8m lattice beam\*

It reduces the risk of materials falling from height and removes excess tube weight on the handrails

\* Subject to maximum payload



Look for the SkyRakEdge™ icon to identify which machines can benefit from this unique attachment.

SkyTel from Nationwide Platforms is the latest innovation in safety and efficiency, reducing the need for the manual handling of antennas in the telecoms sector.

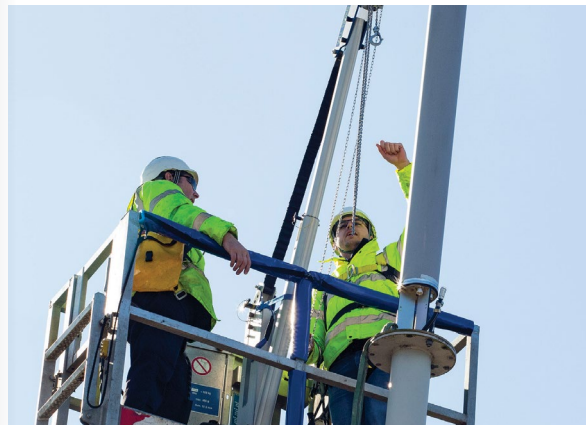

Provides a consistent, safe method of work for the installation and removal of antennas. Easily installed and removed in minutes.



Look for the SkyTel icon to identify which machines can benefit from this unique attachment.



SkyRakTether™, the lightweight tested tethering post for Mobile Elevating Work Platforms utilises a bespoke tethering bag providing safe storage for all tethered tools allowing operators to work freely at height and reducing the risk associated with items falling from height.

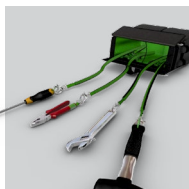

- Reduces the risk of tools falling from height
- Safe tool storage when not in use
- Improves productivity
- Complies with many Tier One company's tethering policies
- Complies with HSE guidance

Compatible with a wide range of booms and scissors type MEWPs.

SkyShield is a robust, lightweight screen providing maximum visibility and offers a safer working environment helping to provide COVID-19 protection

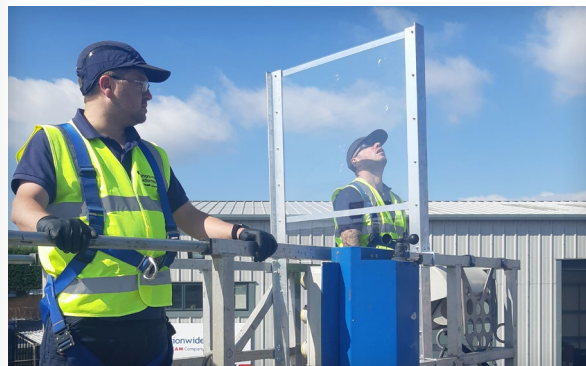

The lightweight aluminium frame holds a UV stable shatterproof polycarbonate barrier requires no tools to fit.

SkyShield is wind rated compliant and compatible with a range of vehicle mounted booms platforms including: GSR 22m, Ruthmann 28m (4x4) & 33m Bronto 38m, 50m, 56m, 70m, 90m – all with extending basket to 3.7m



Look for the SkyShield icon to identify which machines can benefit from this unique attachment.

## Harness and Lanyards

IPAF strongly recommends that a full body harness with an adjustable lanyard (used to provide work restraint and adjusted to be as short as possible) is used when working from a boom type MEWP or vehicle mounted boom.

For more information from IPAF and details of their 'Clunk Click' harness campaign visit [www.ipaf.org](http://www.ipaf.org).

Harness and lanyards sets are available to purchase at the time of hire.

## Wheel Covers and Nappies

Most electric machines are fitted with non-marking tyres, designed to minimise the risk of damaging finished floors. These machines are easily identified by the non-marking tyre icon at the top of each page in the machine specification section of this brochure.

If a machine without non-marking tyres is required for work on a finished floor, wheel covers can be fitted to protect the flooring.

## Lighting Frames and Camera Cages

Nationwide Platforms offers a variety of machines suitable for mounting lighting equipment and cameras, making them ideal for broadcast, cinema and other media applications.



For easy reference look out for the icons to identify which machines can be fitted with optional extras designed for media and broadcasting applications.

## Key Pads

Key pads can be fitted to machines to minimise theft, unauthorised use of the machine and downtime caused by unscheduled equipment use. The key pads are programmable and weatherproof. Simply request a key pad when you place your order.

## Pre-use Inspection Cards

Are your operators complying with the law each time they use powered access machines?

Regulations state that pre-use checks must be made before any operator uses an access platform, with users also required to make a record.

Our daily inspection cards have been designed to help powered access users conform to the law by acting as a comprehensive checklist and record of machine use.

**Daily inspection sheets are now available to order with all hires.**

## Daily Machine Inspections

All of our powered access platforms are subject to extensive safety maintenance checks before they reach you. For extra peace of mind when machines are on your site for longer periods of work, we can also organise daily inspections by a qualified engineer from your local depot.

Please call today and ask for details on our pre-use inspection cards.

0345 745 0000  
[nationwideplatforms.co.uk](http://nationwideplatforms.co.uk)



 **Nationwide Platforms**  
A **LOXAM** Company



## Power to Platform

Most machines are fitted with a 110v socket at ground level that can be connected to your power source. Power is fed through an internal lead within the machine structure to the platform socket. Using this feature ensures that extension cables do not become trapped in the machine or dangle over buildings and other workers.



For easy reference look out for the icon to identify which machines have power to platform.

## Onboard Generators

Many diesel powered machines also have an onboard generator which removes the need to hire a separate generator or have leads trailing from the machine across the workplace. Please request an onboard generator when ordering your machine.



Look out for the icon to identify the machines which can be hired with on board generators.

## Chalwyn Valves

Chalwyn valves can be attached to a diesel engine air intake system. The valve is designed to safely shutdown the engine in the event of external vapours or gasses being sucked into the engine through the air intake.

In areas where there is a chance of vapour ignition a chalwyn valve will normally be specified by the site owner. Typical uses are in petrochemical plants and refineries including refurbishment of petrol station forecourts.

The valve can be fitted to all diesel scissor and boom lifts.

Please note: a minimum of 48 hours notice is required to fit the chalwyn valve.

## Spark Arrestors

Spark arrestors are attached to the exhaust system of diesel machines to eliminate sparks from exiting the exhaust. Spark arrestors are usually specified by the site contractor or operator and are typically required on petrol station refurbishments, petrochemical plant works and refineries. Spark arrestors can be fitted on request, but must be fitted before the machine reaches site.

Please note: a minimum of 48 hours notice is required prior to delivery.

## Earth Bonding

Nationwide Platforms has the UK's largest fleet of boom lifts fitted with earth straps that conform to National Grid specification. This continual safety link running from the platform to the ground safely deflects electric currents, protecting both the machine and its operator from electrocution.

Many site operators request earth bonding if the machine is to be used near live electrical apparatus in locations such as sub stations, power stations and live overhead cables.

Please remember to inform us at the time of booking if you require earth bonding on your machine.

# Weight Conversion

# Distance Conversion

Metric to Imperial (kg x 2.2046 = lbs)				Imperial to Metric (lbs x 0.4536 = kg)			
kg	lbs	kg	lbs	lbs	kg	lbs	kg
500	- 1,102	27,000	- 59,524	1,000	- 453	54,000	- 24,493
1,000	- 2,204	27,500	- 60,627	2,000	- 907	55,000	- 24,947
1,500	- 3,306	28,000	- 61,729	3,000	- 1,360	56,000	- 25,401
2,000	- 4,409	28,500	- 62,831	4,000	- 1,814	57,000	- 25,854
2,500	- 5,511	29,000	- 63,933	5,000	- 2,267	58,000	- 26,308
3,000	- 6,613	29,500	- 65,036	6,000	- 2,721	59,000	- 26,761
3,500	- 7,716	30,000	- 66,138	7,000	- 3,175	60,000	- 27,215
4,000	- 8,818	30,500	- 67,240	8,000	- 3,628	61,000	- 27,669
4,500	- 9,920	31,000	- 68,343	9,000	- 4,082	62,000	- 28,122
5,000	- 11,023	31,500	- 69,445	10,000	- 4,535	63,000	- 28,576
5,500	- 12,125	32,000	- 70,547	11,000	- 4,989	64,000	- 29,029
6,000	- 13,227	32,500	- 71,650	12,000	- 5,443	65,000	- 29,483
6,500	- 14,330	33,000	- 72,752	13,000	- 5,896	66,000	- 29,937
7,000	- 15,432	33,500	- 73,854	14,000	- 6,350	67,000	- 30,390
7,500	- 16,534	34,000	- 74,957	15,000	- 6,803	68,000	- 30,844
8,000	- 17,636	34,500	- 76,059	16,000	- 7,257	69,000	- 31,297
8,500	- 18,739	35,000	- 77,161	17,000	- 7,711	70,000	- 31,751
9,000	- 19,841	35,500	- 78,264	18,000	- 8,164	71,000	- 32,205
9,500	- 20,943	36,000	- 79,366	19,000	- 8,618	72,000	- 32,658
10,000	- 22,046	36,500	- 80,468	20,000	- 9,071	73,000	- 33,112
10,500	- 23,148	37,000	- 81,570	21,000	- 9,525	74,000	- 33,565
11,000	- 24,250	37,500	- 82,673	22,000	- 9,979	75,000	- 34,019
11,500	- 25,353	38,000	- 83,775	23,000	- 10,432	76,000	- 34,472
12,000	- 26,455	38,500	- 84,877	24,000	- 10,886	77,000	- 34,926
12,500	- 27,557	39,000	- 85,980	25,000	- 11,339	78,000	- 35,380
13,000	- 28,660	39,500	- 87,082	26,000	- 11,793	79,000	- 35,833
13,500	- 29,762	40,000	- 88,184	27,000	- 12,246	80,000	- 36,287
14,000	- 30,864	40,500	- 89,287	28,000	- 12,700	81,000	- 36,740
14,500	- 31,966	41,000	- 90,389	29,000	- 13,154	82,000	- 37,194
15,000	- 33,069	41,500	- 91,491	30,000	- 13,607	83,000	- 37,648
15,500	- 34,171	42,000	- 92,594	31,000	- 14,061	84,000	- 38,101
16,000	- 35,273	42,500	- 93,696	32,000	- 14,514	85,000	- 38,555
16,500	- 36,376	43,000	- 94,798	33,000	- 14,968	86,000	- 39,008
17,000	- 37,478	43,500	- 95,900	34,000	- 15,422	87,000	- 39,462
17,500	- 38,580	44,000	- 97,003	35,000	- 15,875	88,000	- 39,916
18,000	- 39,683	44,500	- 98,105	36,000	- 16,329	89,000	- 40,369
18,500	- 40,785	45,000	- 99,207	37,000	- 16,782	90,000	- 40,823
19,000	- 41,887	45,500	- 100,310	38,000	- 17,236	91,000	- 41,276
19,500	- 42,990	46,000	- 101,412	39,000	- 17,690	92,000	- 41,730
20,000	- 44,092	46,500	- 102,514	40,000	- 18,143	93,000	- 42,184
20,500	- 45,194	47,000	- 103,617	41,000	- 18,597	94,000	- 42,637
21,000	- 46,297	47,500	- 104,719	42,000	- 19,050	95,000	- 43,091
21,500	- 47,399	48,000	- 105,792	43,000	- 19,504	96,000	- 43,544
22,000	- 48,501	48,500	- 106,924	44,000	- 19,958	97,000	- 43,998
22,500	- 49,603	49,000	- 108,026	45,000	- 20,411	98,000	- 44,452
23,000	- 50,706	49,500	- 109,128	46,000	- 20,865	99,000	- 44,905
23,500	- 51,808	50,000	- 110,231	47,000	- 21,318	100,000	- 45,359
24,000	- 52,910	50,500	- 111,333	48,000	- 21,772	101,000	- 45,812
24,500	- 54,013	51,000	- 112,435	49,000	- 22,226	102,000	- 46,266
25,000	- 55,115	51,500	- 113,537	50,000	- 22,679	103,000	- 46,719
25,500	- 56,217	52,000	- 114,640	51,000	- 23,133	104,000	- 47,173
26,000	- 57,320	52,500	- 115,742	52,000	- 23,586	105,000	- 47,627
26,500	- 58,422	53,000	- 116,844	53,000	- 24,040	106,000	- 48,081

Metric to Imperial (m x 3.2808 = ft)				Imperial to Metric (ft x 0.3048 = m)			
m	ft	m	ft	ft	m	ft	m
6.0	- 19' 8"	39.5	- 129' 7"	15	- 4.57		
6.5	- 21' 4"	40.0	- 131' 3"	20	- 6.10		
7.0	- 23' 0"	40.5	- 132' 10"	25	- 7.62		
7.5	- 24' 7"	41.0	- 134' 6"	30	- 9.14		
8.0	- 26' 4"	41.5	- 136' 2"				
8.5	- 27' 11"	42.0	- 137' 10"	35	- 10.67		
9.0	- 29' 4"	42.5	- 139' 6"	40	- 12.19		
9.5	- 31' 2"	43.0	- 141' 1"				
10.0	- 32' 10"	43.5	- 142' 9"	45	- 13.72		
10.5	- 34' 6"	44.0	- 144' 5"	50	- 15.24		
11.0	- 36' 1"	44.5	- 146' 0"	55	- 16.76		
11.5	- 37' 10"	45.0	- 147' 7"	60	- 18.29		
12.0	- 39' 5"	45.5	- 149' 3"	65	- 19.81		
12.5	- 41' 0"	46.0	- 150' 11"				
13.0	- 42' 8"	46.5	- 152' 7"	70	- 21.34		
13.5	- 44' 3"	47.0	- 154' 3"	75	- 22.86		
14.0	- 45' 11"	47.5	- 155' 10"	80	- 24.38		
14.5	- 47' 7"	48.0	- 157' 6"	85	- 25.91		
15.0	- 49' 2"	48.5	- 159' 1"	90	- 27.43		
15.5	- 50' 10"	49.0	- 160' 9"	95	- 28.96		
16.0	- 52' 6"	49.5	- 162' 5"	100	- 30.48		
16.5	- 54' 1"	50.0	- 164' 1"	105	- 32.00		
17.0	- 55' 9"	50.5	- 165' 9"				
17.5	- 57' 5"	51.0	- 167' 4"	110	- 33.53		
18.0	- 59' 1"	51.5	- 168' 11"	115	- 35.05		
18.5	- 60' 8"	52.0	- 170' 7"	120	- 36.58		
19.0	- 62' 3"	52.5	- 172' 3"	125	- 38.10		
19.5	- 63' 11"	53.0	- 173' 10"	130	- 39.62		
20.0	- 65' 7"	53.5	- 175' 6"	135	- 41.15		
20.5	- 67' 3"	54.0	- 177' 2"	140	- 42.67		
21.0	- 68' 11"	54.5	- 178' 10"	145	- 44.20		
21.5	- 70' 7"	55.0	- 180' 6"	150	- 45.72		
22.0	- 72' 2"	55.5	- 182' 1"	155	- 47.24		
22.5	- 73' 9"	56.0	- 183' 9"	160	- 48.77		
23.0	- 75' 6"	56.5	- 185' 4"	165	- 50.29		
23.5	- 77' 1"	57.0	- 187' 0"	170	- 51.82		
24.0	- 78' 9"	57.5	- 188' 8"	175	- 53.34		
24.5	- 80' 4"	58.0	- 190' 3"	180	- 54.86		
25.0	- 82' 0"	58.5	- 191' 11"	185	- 56.39		
25.5	- 83' 7"	59.0	- 193' 7"	190	- 57.91		
26.0	- 85' 3"	59.5	- 195' 2"	195	- 59.44		
26.5	- 86' 11"	60.0	- 196' 9"	200	- 60.96		
27.0	- 88' 7"	60.5	- 198' 6"	205	- 62.48		
27.5	- 90' 3"	61.0	- 200' 1"	210	- 64.01		
28.0	- 91' 9"	61.5	- 201' 9"	215	- 65.53		
28.5	- 93' 6"	62.0	- 203' 5"	220	- 67.06		
29.0	- 95' 1"	62.5	- 205' 0"	225	- 68.58		
29.5	- 96' 9"	63.0	- 206' 8"	230	- 70.10		
30.0	- 98' 4"	63.5	- 208' 3"	235	- 71.63		
30.5	- 100' 1"	64.0	- 209' 11"	240	- 73.15		
31.0	- 101' 10"	64.5	- 211' 8"	245	- 74.68		
31.5	- 103' 5"	65.0	- 213' 3"	250	- 76.20		
32.0	- 105' 0"	65.5	- 214' 11"	255	- 77.72		
32.5	- 106' 8"	66.0	- 216' 6"	260	- 79.24		
33.0	- 108' 3"	66.5	- 218' 3"	265	- 80.77		
33.5	- 109' 11"	67.0	- 219' 10"	270	- 82.30		
34.0	- 111' 7"	67.5	- 221' 6"	275	- 83.82		
34.5	- 113' 2"	68.0	- 223' 1"				
35.0	- 114' 10"	68.5	- 224' 9"				
35.5	- 116' 6"	69.0	- 226' 4"				
36.0	- 118' 1"	69.5	- 228' 0"				
36.5	- 119' 9"	70.0	- 229' 8"				
37.0	- 121' 5"	70.5	- 231' 4"				
37.5	- 123' 0"	71.0	- 232' 11"				
38.0	- 124' 8"	71.5	- 234' 7"				
38.5	- 126' 4"	72.0	- 236' 2"				
39.0	- 127' 11"	72.5	- 237' 5"				



**PLEASE NOTE:**

All technical information referred to in this document is intended for guidance purposes only and does not act as a replacement for the full manufacturer specification or equipment user guides.

All information provided is subject to alteration and amendment without prior notice. Please contact Nationwide Platforms for confirmation of machine performance and specification when placing your order.